



Best Management Practices (BMPs) for Soils Treatment Technologies

Suggested Operational Guidelines to Prevent Cross- Media Transfer of Contaminants During Cleanup Activities

DISCLAIMER

This document was prepared by the U.S. Environmental Protection Agency (EPA) in order to provide guidance in preventing cross-media transfer of contaminants during implementation of soils treatment technologies. EPA does not make any warranty or representation, express or implied with respect to the accuracy, completeness or usefulness of the information contained in this report. EPA does not assume any liability with respect to the use of, or for damages resulting from the use of, any information, apparatus, method or process disclosed in this report. Reference to trade names or specific commercial products, commodities, or services in this report does not represent or constitute an endorsement, recommendation, or favoring by EPA of the specific commercial product, commodity, or service. In addition, the policies set out in this document are not final agency action, but are intended solely as guidance. They are not intended, nor can they be relied upon, to create any rights enforceable by any party in litigation with the United States. EPA officials may decide to follow the guidance provided in this document, or to act at variance with the guidance, based on an analysis of specific site circumstances. The Agency also reserves the right to change this guidance at any time without public notice.

PREFACE

This document has been prepared by the U.S. Environmental Protection Agency's Office of Solid Waste. To minimize the cross-media transfer of contaminants during Remedial Actions (RAs) or Corrective Measure Implementations (CMIs), this effort was undertaken to develop the Best Management Practices (BMPs) for various soils treatment technologies. This document was developed by a team effort led by EPA's Office of Solid Waste. The names of team members, their affiliation, and area of assistance are listed below:

Team Members

Ed Barth, P.E.	EPA/ORD/NRMRL- Cincinnati	Other Physical/Chemical
Ray Cody	EPA/Region 1	Vapor Extraction
Subijoy Dutta, P.E.	EPA/OSW/PSPD	Team Leader
Michael Forlini	EPA/TIO	Bioremediation
Scott Frederick	EPA/OERR	Superfund Coordination
Larry Gonzalez	EPA/OSW/HWMMD	Other Physical/Chemical
Bob Hall	EPA/OSW/PSPD	Management Coordination
Carolyn Hoskinson	EPA/OSW/PSPD	HWIR-Media Coordination
José Labiosa	EPA/OSW/HWMMD	Soil Washing
Shaun McGarvey	EPA/OSW/HWMMD	Thermal Treatment
Bonnie Robinson	EPA/OSW/PSPD	Comments Coordination
Larry Rosengrant	EPA/OSW/EMRAD	Universal Table
David Sweeny	New Jersey, DEP	Field Applicability
Debby Tremblay	EPA/OUST	Vapor Extraction

A series of seven workshops on different technology groups was held by the team in developing the document. A list of outside experts who attended these workshops and provided input is furnished below:

Outside Workshop Experts

William Anderson, P.E.	AAEE, Annapolis, MD	Soil Washing/Thermal
Brett Campbell	Geosafe Corp., WA	Insitu Vitrification
David Carson	EPA/ORD/NRMRL	Containment
Harry Compton	EPA/OSWER/OERR- Edison, NJ	OPC
Harsh Dev, PhD	IITRI, IL	RF Heating
Regina Dugan, PhD	Institute for Defense Analyses, VA	Bioremediation
David Ellis, PhD	Dupont Chemicals, DE	Bioremediation
Evan Fan	EPA/ORD/NRMRL	Vapor Extraction
Uwe Frank	EPA/ORD/NRMRL	Vapor Extraction
C.C. Lee	EPA/ORD/NRMRL	Incineration
Mark Meckes	EPA/ORD/NRMRL	Thermal Treatment
Rick Vickery	Dupont Exp. Stn.	Incineration
Kenneth R. Weiss	Delaware DNR	Incineration
John Wilson, PhD	EPA/ORD/NRMRL	Bioremediation

EPA plans to update this document in the future, when new technologies and more effective management practices are developed.

Any questions, clarifications, or suggestions on this document should be addressed to:

Subijoy Dutta, P.E.
U.S. EPA (5303W)
Office of Solid Waste
401 M Street, SW
Washington, DC 20460

email: dutta.subijoy@epamail.epa.gov

CONTENTS

<u>Chapter</u>		<u>Page</u>
	LIST OF TABLES	iv
	LIST OF FIGURES	vi
	LIST OF ACRONYMS	vii
1.0	Chapter One: INTRODUCTION	1
1.1	Regulatory Background and Need for BMPs Guidance	1
1.2	Structure of BMPs Guidance	2
1.3	Examples of BMPs	4
2.0	Chapter Two: GENERAL BMPs for REMEDIATION ACTIVITIES	7
2.1	General Cross-Media Transfer Potentials for Various Treatment Technologies	7
2.2	General Best Management Practices for Soils Treatment Technologies	9
2.2.1	Site Preparation and Staging	9
2.2.2	Pre-Treatment Activities	10
2.2.3	Treatment Activities	11
2.2.4	Post-Treatment Activities/Residuals Management	11
2.3	References	13
3.0	Chapter Three: CROSS-MEDIA TRANSFER CONTROL TECHNOLOGIES and MONITORING	
3.1	Available Control Technologies	14
3.2	Relative Costs of Implementing BMPs	28
3.3	References	29
4.0	Chapter Four: BMPs for CONTAINMENT TECHNOLOGIES	31
4.1	Definition and Scope of Containment Technologies (for BMPs)	31
4.1.1	Key Features of Containment Technologies for the Purpose of BMPs	31
4.2	Containment Technology Description	33
4.3	Cross-Media Transfer Potential of Containment Technologies	34
4.4	Best Management Options to Avoid Potential Cross-Media Transfers for Containment Technologies	34
4.5	Waste Characteristics that May Increase the Likelihood of Cross-Media Contamination for Containment Technologies	36
4.6	References	36
5.0	Chapter Five: BMPs for SOIL WASHING	38
5.1	Definition and Scope of Soil Washing (for BMPs)	38
5.1.1	Key Features of Soil Washing Technology for the Purpose of BMPs	38
5.2	Soil Washing Technology Description	39
5.3	Cross-Media Transfer Potential of Soil Washing Technologies	40
5.4	Best Management Options to Avoid Potential Cross-Media Transfers for Soil Washing Technologies	41

5.5	Waste Characteristics that May Increase the Likelihood of Cross-Media Contamination for Soil Washing Technologies	44
5.6	References	45
6.0	Chapter Six: BMPs for THERMAL TREATMENT	47
6.1	Definition and Scope of Thermal Treatment (for BMPs)	47
6.1.1	Key Features of Thermal Treatment for the Purpose of BMPs	47
6.2	Thermal Treatment Technology Description	49
6.3	Cross-Media Transfer Potential of Thermal Treatment Technologies	49
6.4	Best Management Options to Avoid Potential Cross-Media Transfers for Thermal Treatment Technologies	50
6.5	Waste Characteristics that May Increase the Likelihood of Cross-Media Contamination for Thermal Treatment Technologies	52
6.6	References	52
7.0	Chapter Seven: BMPs for VAPOR EXTRACTION	54
7.1	Definition and Scope of Vapor Extraction (for BMPs)	54
7.1.1	Key Features of Vapor Extraction Technology for the Purpose of BMPs	54
7.2	Vapor Extraction Technology Description	56
7.3	Cross-Media Transfer Potential of Vapor Extraction Technologies	56
7.4	Best Management Options to Avoid Potential Cross-Media Transfers for Vapor Extraction Technologies	57
7.5	Waste Characteristics that May Increase the Likelihood of Cross-Media Contamination for Vapor Extraction Technologies	59
7.6	References	60
8.0	Chapter Eight: BMPs for BIOREMEDIATION	62
8.1	Definition and Scope of Bioremediation (for BMPs)	62
8.1.1	Key Features of Bioremediation for the Purpose of BMPs	64
8.2	Bioremediation Technology Description	64
8.3	Cross-Media Transfer Potential of Bioremediation Technologies	66
8.4	Best Management Options to Avoid Potential Cross-Media Transfers for Bioremediation Technologies	67
8.5	Waste Characteristics that May Increase the Likelihood of Cross-Media Contamination for Bioremediation Technologies	68
8.6	References	69
9.0	Chapter Nine: BMPs for INCINERATION TREATMENT	72
9.1	Definition and Scope of Incineration Treatment (for BMPs)	72
9.1.1	Key Features of Incineration for the Purpose of BMPs	78
9.2	Incineration Technology Description	78
9.3	Cross-Media Transfer Potential of Incineration Technologies	78
9.4	Best Management Options to Avoid Potential Cross-Media Transfers for Incineration Technologies	79
9.5	Waste Characteristics that May Increase the Likelihood of Cross-Media Contamination for Incineration Technologies	80
9.6	References	81

10.0	Chapter Ten: BMPs for OTHER PHYSICAL/CHEMICAL TREATMENTS	82
10.1	Definition and Scope of Other Physical and Chemical Treatment (for BMPs)	82
10.2	In Situ Radio Frequency (RF) Heating	83
10.2.1	Definition and Scope of In Situ RF Heating (for BMPs)	83
10.2.1.1	Key Features of In Situ RF Heating for the Purpose of BMPs	84
10.2.2	In Situ RF Heating Technology Description	85
10.2.3	Cross-Media Transfer Potential of In Situ RF Heating	85
10.2.4	Best Management Options to Avoid Potential Cross-Media Transfers During In Situ RF Heating	86
10.2.5	Waste Characteristics that May Increase the Likelihood of Cross-Media Contamination for In Situ RF Heating	87
10.3	In Situ Vitrification	88
10.3.1	Definition and Scope of In Situ Vitrification (ISV) (for BMPs)	88
10.3.1.1	Key Features of In Situ Vitrification for the Purpose of BMPs	89
10.3.2	In Situ Vitrification Technology Description	90
10.3.3	Cross-Media Transfer Potential of In Situ Vitrification	90
10.3.4	Best Management Options to Avoid Potential Cross-Media Transfers During ISV	90
10.3.5	Waste Characteristics that May Increase the Likelihood of Cross-Media Contamination for In Situ Vitrification Technologies	91
10.4	In Situ Soil Flushing	92
10.4.1	Definition and Scope of In Situ Soil Flushing (for BMPs)	92
10.4.1.1	Key Features of In Situ Soil Flushing for the Purpose of BMPs	93
10.4.2	In Situ Soil Flushing Technology Description	95
10.4.3	Cross-Media Transfer Potential of In Situ Soil Flushing	95
10.4.4	Best Management Options to Avoid Potential Cross-Media Transfers During In Situ Soil Flushing	95
10.4.5	Waste Characteristics that May Increase the Likelihood of Cross-Media Contamination for In Situ Flushing Technologies	96
10.5	Solidification/Stabilization	97
10.5.1	Definition and Scope of Solidification/Stabilization (for BMPs)	97
10.5.1.1	Key Features of Solidification/Stabilization for the Purpose of BMPs	98
10.5.2	Solidification and Stabilization Technology Description	98
10.5.3	Cross-Media Transfer Potential of Solidification/Stabilization	99
10.5.4	Best Management Options to Avoid Potential Cross-Media Transfers During Solidification/Stabilization	99
10.5.5	Waste Characteristics That May Increase the Likelihood of Cross-Media Contamination for Solidification and Stabilization Technologies	100
10.6	Excavation and Off-Site Disposal	100
10.6.1	Definition and Scope of Excavation and Off-Site Disposal (for	

		BMPs)	100
	10.6.1.1	Key Features of Excavation and Off-Site Disposal for the Purpose of BMPs	100
	10.6.2	Excavation and Off-Site Disposal Technology Description	101
	10.6.3	Cross-Media Transfer Potential of Excavation and Off-Site Disposal	101
	10.6.4	Best Management Options to Avoid Potential Cross-Media Transfers During Excavation and Off-Site Disposal	101
	10.6.5	Waste Characteristics that May Increase the Likelihood of Cross-Media Contamination for Excavation and Off-Site Disposal Technologies	102
	10.7	References	102
11.0	Chapter Eleven:	FIELD VALIDATION and CASE STUDIES of BMPs	106
	11.1	Soil Washing/Soil Leaching to Treat Metals Contaminated Soil at an Army Ammunition Plant in Minnesota (Site 1)	108
	11.1.1	Description of Site Remediation Activities	108
	11.1.2	BMPs Used to Prevent Cross-Media Transfer of Pollutants	108
	11.1.3	Views and Discussion	111
	11.2	In-Situ Chemical Based Stabilization of Petroleum Contaminated Soil at a Refinery in Minnesota (Site 2)	112
	11.2.1	Description of Site Remediation Activities	112
	11.2.2	BMPs Used to Prevent Cross-Media Transfer of Pollutants	112
	11.2.3	Views and Discussion	114
	11.3	Stabilization and Disposal of Lead Contaminated Soils at a Closed Battery Manufacturing Facility in Virginia (Site 3)	114
	11.3.1	Description of Site Remediation Activities	114
	11.3.2	BMPs Used to Prevent Cross-Media Transfer of Pollutants	115
	11.3.3	Views and Discussion	117
	11.4	Particle Size Separation and Soil Washing at a Site Used Previously for Ammunition Testing and Disposal in Connecticut (Site 4)	117
	11.4.1	Description of Site Remediation Activities	117
	11.4.2	BMPs Used to Prevent Cross-Media Transfer of Pollutants	118
	11.4.3	Views and Discussion	119
	11.5	Soil Vapor Extraction of Solvents at a Closed Electronic Component Manufacturing Facility in Maine (Site 5)	120
	11.5.1	Description of Site Remediation Activities	120
	11.5.2	BMPs Used to Prevent Cross-Media Transfer of Pollutants	120
	11.5.3	Views and Discussion	121
	11.6	Excavation and Thermal Treatment of VOC-Contaminated Soil and Debris at a DOE Site in Colorado (Site 6)	121
	11.6.1	Description of Site Remediation Activities	121
	11.6.2	BMPs Used to Prevent Cross-Media Transfer of Pollutants	122
	11.6.3	Views and Discussion	124
	11.7	On-Site Containment of Soils in Former Manufacturing Areas at a Chromium Plant, Maryland (Site 7)	124
	11.7.1	Description of Site Remediation Activities	124
	11.7.2	BMPs Used to Prevent Cross-Media Transfer of Pollutants	125
	11.7.3	Views and Discussion	128

11.8	Ex Situ Bioremediation of Explosives Contaminated Soils at a DoD Facility in Virginia (Site 8)	129
11.8.1	Description of Site Remediation Activities	129
11.8.2	BMPs Used to Prevent Cross-Media Transfer of Pollutants	129
11.8.3	Views and Discussion	130
11.9	Comparison of Selected Case Study BMPs With BMPs Recommended in this Guidance	131

LIST OF TABLES

Table 1-1.	Technology-Specific Cross-Media Transfer Concerns and Possible BMPs	5
Table 2-1.	Fractional Contributions of Various Remedial Activities to Total Volatile Contaminant Emissions	8
Table 3-1.	Emissions Sources and Controls During Cleanup Activities	16
Table 3-2.	Technologies for Controlling Cross-Media Transfer of Contaminants During Materials Handling Activities	18
Table 3-3.	Technologies for Reducing Contaminant Concentrations in Air Emissions Generated During Remediation	21
Table 3-4.	Examples of Technologies for Controlling Cross-Media Transfer to Water	24
Table 3-5.	Examples of Field Monitoring Technologies	26
Table 11-1.	Key Characteristics of BMP Case Study Sites	107
Table 11-2.	Examples of Field/Case Study Findings and Relevant Modifications of the BMP Guidance Document	134

LIST OF FIGURES

Figure 3-1.	Relative Cost Effectiveness for Point Source VOC Controls	29
Figure 4-1.	Cross-Sectional View Showing Implementation of Slurry Walls	32
Figure 4-2.	Cross-Section of Multilayer Landfill Cover	32
Figure 5-1.	Basic Soil Washing Flow Diagram	39
Figure 6-1.	Schematic of a Thermal Desorption Treatment System	48
Figure 7-1.	Schematic of a Soil Vapor Extraction System	55
Figure 8-1.	Schematic for Solid Phase Bioremediation	63
Figure 8-2.	Diagram of Solid Phase Biological Treatment Using a Composting Pile	66
Figure 9-1.	Schematic Diagram of a Typical Incineration Facility	73
Figure 9-2.	Typical Liquid Injection Incinerator	74
Figure 9-3.	Typical Fixed/Sloped Hearth Incinerator	75
Figure 9-4.	Typical Multiple Hearth Incinerator	76
Figure 9-5.	Typical Rotary Kiln Incinerator	77
Figure 10-1.	Schematic Diagram of an In Situ RF Heating System	83
Figure 10-2.	Cross-Section of an In Situ RF Heating System	84
Figure 10-3.	ISV Equipment System	88
Figure 10-4.	A Cut-Away View of a Typical Treatment Cell	89
Figure 10-5.	Schematic of In Situ Flushing Field Test System	93
Figure 10-6.	Soil Flushing Sprinkler System	94
Figure 10-7.	Schematic of Soil Flushing System	94
Figure 10-8.	Generic Elements of Typical S/S Processes	97

LIST OF ACRONYMS

AEC	Area of Environmental Concern
APCD	Air Pollution Control District
ASME	American Society of Mechanical Engineers
ASTM	American Society of Testing and Materials
ATP	Anaerobic Thermal Process
BACT	Best Available Control Technology
BDAT	Best Demonstrated Available Technology
BOD	Biochemical Oxygen Demand
BMPs	Best Management Practice(s)
BPT	Best Practicable Technology
BPCT	Best Practicable Control Technology
CAO	Corrective Action Order
CAP	Corrective Action Plan
CERCLA	Comprehensive Environmental Response, Compensation, and Liability Act of 1980
CFM	Cubic Feet Per Minute
CFR	Code of Federal Regulations
CMI	Corrective Measure Implementation
CMIPP	Corrective Measure Implementation (Program Plan)
COD	Chemical Oxygen Demand
CAMU	Corrective Action Management Unit
CSFS	Contaminated Soil Feed Stockpiles
CWA	Clean Water Act
DEP	Department of Environmental Protection
DM	Dust Monitor
DNAPL	Dense Non-Aqueous Phase Liquid
DNR	Department of Natural Resources
DoD	Department of Defense
DOE	Department of Energy
EPA	U.S. Environmental Protection Agency
FACA	Federal Advisory Committee Act
FCC	Federal Communications Commission
FFA	Federal Facility Agreement
FID	Flame Ionization Detector
FR	Federal Register
GAC	Granular Activated Carbon
GC/MS	Gas Chromatography/Mass Spectrometry
GCLs	Geosynthetic Clay Liners
GPD	Gallons Per Day
HWIR	Hazardous Waste Identification Rule
HWMD	Hazardous Waste Minimization and Management Division of OSW/EPA
IRP	Installation Restoration Program
ISM	Industrial, Scientific, and Medical
ISV	In Situ Vitrification
LNAPL	Light Non-Aqueous Phase Liquid
LDR	Land Disposal Restrictions
MPCA	Minnesota Pollution Control Agency

NIOSH	National Institute of Occupational Safety and Health
NPDES	National Pollutant Discharge Elimination System (CWA)
NRMRL	National Risk Management Research Laboratory
OD	Outside Diameter
OERR	Office of Emergency and Remedial Response
OPC	Other Physical/Chemical Treatment
ORD	Office of Research and Development
OSW	Office of Solid Waste
OSWER	Office of Solid Waste and Emergency Response
OUST	Office of Underground Storage Tanks
OVA	Organic Vapor Analyzer
OW	Office of Water
PASP	Perimeter Air Sampling Program
PCE	Perchloroethylene
PIC	Products of Incomplete Combustion
PID	Photoionization Detector
PM	Particulate Matter
POHC	Principal Organic Hazardous Constituent
PPB	Parts Per Billion
PPM	Parts Per Million (mg/l)
PSPD	Permits and State Programs Division of OSW/EPA
PVC	Polyvinyl Chloride
RA	Remedial Action
RD	Remedial Design
RCRA	Resource Conservation and Recovery Act
RF	Radio Frequency
RFI	RCRA Facility Investigation
RI	Remedial Investigation
RI/FS	Remedial Investigation/Feasibility Study
RSKERRL	Robert S. Kerr Environmental Research Laboratory
SARA	Superfund Amendments and Reauthorization Act of 1986
SDWA	Safe Drinking Water Act
SHSP	Site Health and Safety Plan
SITE	Superfund Innovative Technology Evaluation
SPCC	Spill Prevention, Containment, and Countermeasure (CWA)
SPLP	Synthetic Precipitation Leaching Procedure (EPA Method 1312)
S/S	Solidification/Stabilization
SU	Standard Unit
SVE	Soil Vapor Extraction
SVOC	Semi-Volatile Organic Compound
SWDA	Solid Waste Disposal Act
TCE	Trichloroethylene
TCLP	Toxicity Characteristic Leaching Procedure (EPA Method 1311)
TDU	Thermal Desorption Unit
TIO	Technology Innovation Office
TPH	Total Petroleum Hydrocarbons
TRPH	Total Recoverable Petroleum Hydrocarbons
TSDF	Treatment, Storage and Disposal Facility
TSS	Total Suspended Solids

TWA	Time Weighted Average
USEPA	U.S. Environmental Protection Agency
UST	Underground Storage Tank
UXO	Unexploded Ordnance
VOC	Volatile Organic Compound
WIPP	Waste Isolation Pilot Plant
WMD	Waste Management Division of OSW/EPA
XRF	X-Ray Fluorescence

1.0 Chapter One: INTRODUCTION

This document provides guidance on how to design and conduct soil remediation activities at RCRA and other hazardous waste sites so that transfers of contaminants from contaminated soil to other media (i.e., clean soil, air, and surface or ground water) are minimized. Its primary purpose is to provide guidance on preventing cross-media transfers of contaminants during implementation of soils treatment technologies for treating contaminated soils or solid media in compliance with applicable state and/or federal regulations. Releases that may result in transfer of contaminants from the soil or solid media to water, air or other natural media are generally referred to as cross-media transfer.

This document is not meant to direct or guide selection of appropriate treatment technologies. Rather, it is only meant to provide advice on the operational practices relating to prevention and control of cross-media contamination (hereafter referred to as "Best Management Practices" or "BMPs") that, based on research and past experience, may be best for the selected technology.

As described below, efforts to develop this document were initiated to support implementation of the proposed Hazardous Waste Identification Rule for contaminated media (HWIR-media). However, EPA believes that the guidance contained herein will be useful in many different situations involving cleanup activities, where parties implementing a soil treatment technology want to be attentive to cross-media contamination concerns and minimize any adverse impact on the overall environment. This document does not replace any existing state or federal regulations or guidance.

This document is also expected to assist in reducing worker exposure to contaminants by identifying the potentials for cross-media transfer and recommending possible control mechanisms during implementation of soils treatment technologies. Although it is beyond the scope of this document to address the worker health and safety issues, the recommended BMPs are expected to passively alleviate many of the worker health and safety concerns during soils treatment technology implementation.

The cost of implementing the recommended BMPs are generally subsumed in the overall treatment technology implementation. No specific incremental cost estimates are available at this time for application of the recommended BMPs. However, based upon the information gathered from a few case studies, a short synopsis on the relative cost of implementing BMPs is provided in Section 3.2 of this document.

1.1 Regulatory Background and Need for BMPs Guidance

The Best Management Practices (BMPs) for Soils Treatment Technologies were developed to provide guidance on how to identify and minimize the potential for causing cross-media contamination during implementation of cleanup technologies for contaminated soils or solid media. The guidance outlines the specific potential cross-media concerns for specific activities and recommends approaches for preventing cross-media transfer of contaminants.

EPA originally began to develop the BMPs guidance in response to concerns that some cleanup activities may unintentionally cause additional contamination through cross-media transfer of contaminants. Stakeholders involved in the development of HWIR-media raised these concerns to EPA.

The BMPs guidance was not developed for and should not be used as a compliance guide for any particular set of cleanup standards, but instead should be used as a reference during implementation of those standards. The Agency expects that it will be of use in many contexts, including Superfund cleanups, RCRA Subtitle C corrective action, UST corrective action, and state cleanups. If any of the recommendations provided in this guidance causes a conflict with a state or federal regulation, such conflict is unintentional, and the applicable regulation should be followed.

BMPs are not meant to be used as a selection tool for remedial treatment technologies, rather they should be used during the implementation stage of remedies once they are selected. EPA believes that this document will be of unique assistance where parties implementing a soil treatment technology want to be attentive to cross-media contamination concerns.

1.2 Structure of BMPs Guidance

The structure of this guidance document is the result of several rounds of analysis and review of the task at hand and the information developed to accomplish it.

Developing and compiling BMPs for each existing soil treatment technology would be a monumental undertaking. To simplify the effort, the BMP team grouped technologies based on common features and similarities in their ability to give rise to cross-media transfers of contaminants. This resulted in the following seven technology categories:

- Containment Technologies
- Soil Washing
- Thermal Treatment
- Vapor Extraction
- Bioremediation
- Incineration
- Other Physical/Chemical Treatments

It was recognized by the peer reviewers and BMP team members that implementation of many technologies involved common activities. To streamline the document and make it easier to use, BMPs for common activities were compiled into a single chapter. Similarly, information on technologies used for controlling cross-media transfers of contaminants were also compiled in one chapter for quick reference and to minimize repetition. Individual chapters on different technology categories are made much more technology specific. Other characteristics of initial draft guidance, such as organizing BMPs by remedial stage or phase (e.g., site preparation and staging), were also maintained but improved upon wherever possible, in accordance with reviewers' comments.

The remainder of this BMPs guidance is structured into ten chapters as follows:

Chapter 2 presents BMPs that are not specific to any particular soils treatment technology. In most cases, these BMPs are applicable across a range of remedial activities and several or most remediation technologies. As presented, these BMPs address specific cross-media transfer concerns (e.g., fugitive dust emissions, surface and ground water contamination by runoff), providing information on operational activities that can reduce the likelihood of transfers during remediation activities. The information in this chapter is organized relative to various remedial stages: site preparation and staging, pre-treatment, and post-treatment/residuals management. Technology-specific BMPs are provided later in Chapters 4 through 10.

Chapter 3 provides information on control technologies that can be used in conjunction with BMPs to reduce the likelihood of cross-media contamination during soil remediation activities. The information in this chapter is organized in a series of five tables.

Chapters 4 through 10, respectively, present technology-specific BMPs for each of the seven technology categories and, in some cases, for specific technologies within those categories. References to Chapters 2 and 3 are provided wherever applicable. More specifically, each chapter provides the following information:

- **Definition and Scope.** For each technology category, the guidance provides a definition of the technology and describes the purpose and applications of the technologies in each category. A description of the key features common to all the technologies within the category is also provided. When a new technology is introduced that is not specifically addressed in this guidance, it could be matched with an existing technology category with which it shares similar key features, and the appropriate BMPs can be applied.
- **Cross-Media Transfer Potential.** The types of potential releases (e.g., fugitive dust emissions, volatile organic compound (VOC) emissions, leaching of contaminants to ground water) that are of concern for the general technology category and, if they differ, for specific technologies within the category are identified. Types of potential releases are tied to the remedial stage during which they are most likely to occur.
- **The Best Management Options to Avoid Potential Cross-Media Transfers.** For the four major stages of the remediation process, this guidance discusses those management options or practices, also called BMPs, that are generally considered best to minimize cross-media transfer of contamination. For example, the BMPs provided here address techniques that can be used to suppress fugitive dusts, gas emissions, and odors; minimize surface and ground water contamination; limit the effects of human and animal access across sites; and other methods that can help to avoid potential cross-media transfers during all activities associated with site remediation. Most of the BMPs in many chapters address activities within the treatment stage of remediation because those tend to be the most technology specific.

Where appropriate, however, BMPs for technology-specific activities that occur in other stages are also offered.

- **Waste Characteristics that May Increase the Likelihood of Cross-Media Contamination for this Technology.** An overview is provided of site conditions and waste characteristics that might result in a greater likelihood of cross-media transfer of contaminants when a technology is applied in less than optimal site conditions or to treat contaminants for which its effectiveness may be limited.
- **Residuals Management.** Common post-treatment and residual management issues have been addressed in Chapter 2 of this guidance, which identifies the types of residuals that might be generated by the implementation of technologies within particular categories and discusses the options available for the management of residuals to prevent cross-media contamination. This guidance only addresses those residuals that have some potential for cross-media transfer of contaminants or their by-products created during treatment.

Chapter 11 provides case studies as well as information on field validation activities that EPA undertook at soil remediation sites in the Fall and Winter of 1996-1997. Useful information gleaned from these case studies and field validation activities, such as the field applicability of BMPs and associated control technologies, has been incorporated into this document as appropriate for the seven technology categories.

In order to easily identify the recommended BMPs, the ✓ bullet has been used exclusively for the recommended BMPs in this document.

1.3 Examples of BMPs

Table 1-1 provides examples of the types of information that can be found in these chapters. Specifically, this table presents technology-specific cross-media transfer concerns for various technology categories and some of the possible BMPs for addressing them. This table is not meant to be comprehensive. Many other concerns, and the BMPs that should be used to address them, are outlined in the individual technology chapters, and the reader is encouraged to review all of the information that is pertinent to a particular technology grouping for best results.

Table 1-1. Technology-Specific Cross-Media Transfer Concerns and Possible BMPs

Technologies	Area of Concern	Possible BMPs to Mitigate Concern
Containment Technologies	Post-Implementation Maintenance: Cracks, microfractures, other breaches of containment unit resulting in leaching of materials to groundwater or release of fugitive emissions to air.	Containment structures should be periodically monitored for cracks, microfracture, or leaks and proper control should be exercised, when necessary, to prevent migration of contaminants. <i>Details of other cross-media transfer concerns and possible BMPs for Containment Technologies are listed in Chapter 4 of this document.</i>
Soil Washing Technologies	Residuals Management: Soil washing typically generates large volumes of contaminated waste water or other liquids. Not all of these liquids can be easily treated on-site.	Soils should be cleaned of debris and materials that would increase the requirements for the use of water or other solvents. For example, fine silts and clays should be screened out prior to treatment. In addition, the mixing of soil batches that contain dissimilar contaminants should be avoided. In this way, the liquids that are used to clean the soils can contain fewer additives, which will make them easier to treat for recycling or disposal. <i>Details of other cross-media transfer concerns and possible BMPs for Soil Washing Technologies are listed in Chapter 5 of this document.</i>
Thermal Treatment Technologies	Process Emissions: Stack emissions from organic collection, removal, or destruction of vapors past the thermal desorption, vaporization, or separation treatment have the potential for air release of contaminants that have not been completely destroyed.	Air pollution devices should be properly designed, installed and operated to handle all of the constituents that are anticipated to be separated from the soil under the specific design of the particular thermal technology selected. Products of incomplete reaction (i.e., combustion, if appropriate) should also be handled in the design and operation of the air pollution control devices. Additives to soil being thermally treated have the potential for encouraging complete combustion reactions, thereby reducing emissions. <i>Details of other cross-media transfer concerns and possible BMPs for Thermal Treatment Technologies are listed in Chapter 6 of this document.</i>

Table 1-1. Technology-Specific Cross-Media Transfer Concerns and Possible BMPs (cont'd)

Technologies	Area of Concern	Possible BMPs to Mitigate Concern
Vapor Extraction Technologies	<p>Disposal Of Residuals: Contaminated debris, soils, and liquid wastes resulted from excavation and installation of wells are new sources for potential cross-media transfer of contaminants.</p>	<p>During construction of soil vapor extraction-based systems, construction debris should be properly handled and treated on-site or be disposed off-site. <i>Details of other cross-media transfer concerns and possible BMPs for Vapor Extraction Technologies are listed in Chapter 7 of this document.</i></p>
Bioremediation Technologies	<p>Surface and Ground Water Contamination: Additives used in bioremediation, such as phosphorus and nitrogen, have the potential to migrate into nearby water bodies as runoff if not carefully controlled. In addition, oxygen suppliers, such as hydrogen peroxide, can be flammable, and may require careful handling.</p>	<p>The nutrient-rich run-off should be controlled by the use of berms, moats, or other physical barriers around bioremediation sites. Alternatively, ground-feeding sprinkler systems operated at low volumes can minimize the amount of, and area over which, nutrient-rich water is sprayed, reducing the potential for cross-media contamination. <i>Details of other cross-media transfer concerns and possible BMPs for Bioremediation Technologies are listed in Chapter 8 of this document.</i></p>
Incineration Technologies	<p>Process Emissions: Stack emissions from organic collection/destruction of vapors using thermal desorption, vaporization, or separation treatment have the potential for release as contaminant-laden gas streams into the atmosphere.</p>	<p>Air pollution devices should be properly designed, installed and operated to handle all of the anticipated constituents to be released from the soil during the treatment process. Air pollution control devices should be designed to treat the products of incomplete combustion by ensuring that sufficient oxygen is available during all combustion activities.</p> <p>Additives to the soil being incinerated have the potential for reducing the formation of products of incomplete reaction, thereby reducing emissions. <i>Details of other cross-media transfer concerns and possible BMPs for Incineration Technologies are listed in Chapter 9 of this document.</i></p>

2.0 Chapter Two: GENERAL BMPs for REMEDIATION ACTIVITIES

At many sites with contaminated soil or solid media, remediation activities will be conducted that have the potential to generate cross-media contamination. These activities generally fall within one of four major remedial stages, regardless of the selected technology (although some technologies may not require or have the same level of activity in all stages):

- Site Preparation and Staging
- Pre-Treatment
- Treatment
- Post-Treatment/Residuals Management

These stages are not always discrete and separate from one another. (For example, residuals management is often an issue while treatment is on-going). However, for the purposes of this document, they are treated individually.

This chapter presents best management practices (BMPs) for addressing those remedial activities that are not unique to the technology selected for treating contaminated soil or solid media at a site (but that still have the potential to generate cross-media contamination). In other words, these BMPs are likely to have applicability to a wide variety of sites because they are associated with a common remedial activity, such as excavation, rather than a specific technology, such as soil washing. The BMPs are organized according to the remedial stage to which they pertain (e.g., staging and site preparation), and then to the applicable cross-media transfer concern (e.g., fugitive dust). The types of remedial activities that may give rise to each concern (e.g., clearing and grubbing, excavation) are also presented to help in determining the applicability of BMPs to a particular site.

As reflected in this chapter, BMPs most commonly associated with activities performed as part of site preparation and staging, pretreatment, and post-treatment/residuals management are not technology-specific. BMPs associated with activities that occur in the treatment stage of a remediation are generally technology specific, so they are not addressed here. BMPs for technology-specific activities and cross-media transfer concerns are found in Chapters 4 through 10, which address individual technology categories.

2.1 General Cross-Media Transfer Potentials for Various Treatment Technologies

During implementation of any soils treatment technology the following steps are generally undertaken: a) Site preparation and staging, b) Pre-treatment activities, c) Treatment activities, and d) Post-treatment activities. Specific cross-media concerns during the actual treatment activities are addressed separately under the relevant technology categories in Chapters 4 through 10. General cross-media transfer potential for contaminants mostly during the site preparation, pre-treatment, and post-treatment activities are identified below.

- There is risk of inaccurate site characterization with any soils treatment technology operation. The material encountered at the remedial site may

not be like the soils studied in treatability or pilot-scale tests. Additional contaminants may be encountered, and the percentage of the fine-grained fraction may be significantly different from that expected. These factors may lead to a long-term storage or generation of high residual volume, and thus increase the potential for cross-media transfer.

- During several different activities associated with remedy implementations, including staging and site preparation (e.g., clearing, grubbing); drilling, well installation and trenching operations; mobilization and demobilization of equipment; excavation; transport of materials across the site; and some treatment activities, there is high potential for fugitive dust emissions due to movement of equipment at the site. In addition, these same activities can enhance the volatilization of VOCs, SVOCs, and other potentially hazardous materials into the atmosphere.
- During pretreatment operations such as excavation, storage, sizing, crushing, dewatering, neutralization, blending, and feeding, there is the potential for dust and VOC emissions from the contaminated media.
- Migration of contaminants to uncontaminated areas may occur during mobilization or demobilization.
- VOC and SVOC emissions tend to increase during periods of hot and dry weather.
- Leaching of contaminants to surface water can occur from uncovered stockpiles and excavated pits.
- Improper handling and disposal of residues (e.g., sediment/sludge residuals or post-washing wastewater) may allow contaminants to migrate into and pollute uncontaminated areas.
- Post-treatment discharges of wastewater, if improperly managed, can cause migration of contaminants.

Table 2-1 provides a summary of the fractional contributions of various remedial activities to the generation of volatile contaminant emissions, which is potentially a major source of cross-media contamination during many remedial activities.

Table 2-1. Fractional Contributions of Various Remedial Activities to Total Volatile Contaminant Emissions (USEPA, 1991)

Remedial Activity	Fractional Contribution to Total Volatile Contaminant Emissions for the Entire Site Remediation Process
--------------------------	--

Excavation	0.0509
Bucket (Loading)	0.0218
Truck Filling	0.0905
Transport	0.3051
Dumping	0.5016
Incineration	0.0014
Exposed Soil	0.0287
Total	1.0000

2.2 General Best Management Practices for Soils Treatment Technologies

Various control practices to prevent potential cross-media transfer of contaminants during cleanup activities have been identified in Tables 3-1 to 3-5. Also, proper system design is recommended prior to implementation of the remedial treatment to avoid cross-media transfer problems during different treatment steps. However, general BMP options to control specific cross-media transfer of contaminants for different treatment technologies are furnished below:

2.2.1 Site Preparation and Staging

Prior to movement of equipment on site the following activities are most commonly undertaken:

- ◆ Site inspections; surveying; boundary staking; drilling and trenching; sampling; demarcation of hot spots; and construction of access roads, utility connections, and fencing.

Special attention and care should be taken during site preparation activities so that the contaminated media are not disturbed. In case of unavoidable circumstances, the contaminated media should be subjected to a very minimal disturbance/alteration during these activities. The following BMPs are generally recommended:

- ✓ Avoid entering the contaminated area. In unavoidable circumstances, build a temporary decontamination area, which could be later used during cleanup activities. Any above-ground and underground source of contaminants should be identified and located prior to starting any treatment of contaminated media.
- ✓ Any soils and soil-gas sampling, field air permeability testing, demarcation of hot spot etc. activities should generally be followed by plugging/covering of any holes or depressions created during these activities to prevent intrusion of water. It would also be appropriate to install relevant signs at the same time so that repeated entry to the site is not called for.
- ✓ Contaminated drilling mud from any drilling operations should be collected in a lined/contained system. This will prevent the contaminants from mixing with the normal surface water runoff from the area and the surrounding natural watercourse.
- ✓ Contaminated waste generated during site preparation or further site characterization activities should be managed protectively as specified in Chapter 3, Tables 3-1 to 3-4.
- ✓ Site investigation and operational plans should take into account the presence of permeable zones and account for potential pre-existing underground sewers and electrical conduits.

- ✓ Surface drainage and subsurface utility systems should be identified.
- ✓ Local watershed management goals and priorities should be incorporated into the surface water management plan for the cleanup activities.

2.2.2 Pre-Treatment Activities

Prior to beginning the actual treatment process the following activities are most commonly undertaken:

- ◆ Excavation, transportation, storage, sizing, crushing, dewatering, neutralization, blending, installation of feeding systems for contaminated media etc.

During the above activities, measures should be taken to control fugitive dust emissions and to prevent releases of contaminated media to the natural environment. To prevent cross-media transfer of contaminants, the following BMPs are generally recommended for the above activities:

- ✓ Any aboveground and underground sources of contaminants, such as storage tanks, should generally be removed.
- ✓ Any offsite runoff should be prevented from entering and mixing with on-site contaminated media by building earthen berms or adopting similar other measures, as outlined in Table 3-4.
- ✓ Provisions should generally be made to capture on-site surface water runoff by diverting it to a controlled depression-area or lined pit.
- ✓ Sizing, crushing, and blending activities should be conducted under an environment where the off gases, volatiles, dusts, etc. are all captured inside a hood or cover, or controlled using other options listed in Chapter 3. The dust and VOC emissions associated with these activities that exceed acceptable regulatory limits should be controlled by capturing these emissions and then treating the captured vapor/air to the extent practicable. Measures for preventing, collecting and treating dust and VOC emissions are provided in Tables 3-1 and 3-3.
- ✓ When mixing or dewatering, the contaminated aqueous stream should be collected in a lined/contained system. This will prevent the contaminants from mixing with the normal surface water runoff from the area and the surrounding natural watercourse.
- ✓ Protective management/disposal of contaminated debris is recommended to prevent cross-media transfer. Protective management includes debris washing, providing covers, testing, and appropriate disposal (see Section 11.6.2 (d) and (i)).

- ✓ When treating explosive wastes, proper safety and care should be exercised to prevent any explosion during the treatment process. For conducting safe operations, recommendations provided in the Handbook (USEPA, 1993) may be used, when necessary.
- ✓ The technology design should be checked to ensure that the corrosion factor has been taken into account in the design for all appropriate pipes, valves, fittings, tanks, and feed systems.
- ✓ Entry to the active site should be limited to avoid unnecessary exposure and related transfer of contaminants.
- ✓ The temporary decontamination area described in Section 2.2.1 should be used as recommended earlier to keep the site-related contaminants within the active cleanup area.
- ✓ Fugitive dust emissions should be controlled during excavation by spraying water to keep the ground moist. During wet weather or rainfall no water spraying would be needed.
- ✓ Consideration of climatological extremes/high wind, etc. should be taken into account when conducting any of the treatment or associated activities. Real-time weather data could be used to monitor weather conditions and accordingly control treatment operations. During a recent field visit an onsite weather station was observed. The weather monitoring stations were reported to have nominal cost and were found to be highly useful in controlling weather-related cross-media transfers. To determine possible extreme conditions, local weather data for the past 10 years could be reviewed from publications (NOAA, 1995) of the National Climatic Data Center, 151 Patton Avenue, Asheville, NC 28801-5001, Phone: (704) 271-4800.
- ✓ During excavation, blending, and feeding of contaminated soils, VOC emissions should be monitored and appropriate emission control measures undertaken.
- ✓ Operational plans should include adequate inspection procedures that look specifically for corrosion and wear.
- ✓ It is also critical to check that the air pollution control devices are designed for the corrosive nature of the hot gases that are expected to enter these devices, when used in certain soil treatment technologies.
- ✓ As an effective erosion control practice, scheduling of construction activities should be arranged to limit the time of exposure of disturbed segments of the site. This entails directing work to one area of a site, then completing and stabilizing that area before moving on to other areas of the site.

2.2.3 Treatment Activities

Treatment activities and relevant BMPs are specifically described for each technology category in Chapters 4 through 10.

2.2.4 Post-Treatment Activities/Residuals Management

During the post-treatment process the following activities are most commonly undertaken:

- (a) Vapor (Gas) Phase
 - Collection or destruction of organics
 - Collection of particulates
 - Removal of acid gases

(b) Solid and Liquid Phases

- Treatment or disposal of aqueous wastes
- Disposal of dusts collected as a result of emission control during materials handling, stabilization, or any other tertiary/post-treatment

During the conduct of the above activities, measures should be taken to prevent release of contaminated media to the natural environment. The following BMPs are generally recommended for the above activities:

- ✓ Remedial plans should be checked to ensure that they account for the anticipated differences in characteristics of the treated soil. This may involve recombination of the treated soil with uncontaminated soil from the site (or off-site) in order to approximate the original soil characteristics prior to contamination. The anticipated soil characteristics of the treated soil should be verified prior to replacement.
- ✓ Treated wastes should be checked for leachability prior to disposal in a landfill or other similar systems. Possibilities of long-term degradation and migration of contaminants to groundwater should be carefully evaluated and checked prior to disposal of stabilized/treated material.
- ✓ Contaminated debris, soils, and liquid wastes resulting from excavation and installation of wells should be properly handled, either treated on-site or trucked away for off-site disposal. Berms should be built around the active excavation, storage and treatment areas, if necessary, to prevent migration of contaminated runoff away from the area.
- ✓ If solid materials such as granulated carbon filters are used to collect emissions, they should be removed carefully from the emissions system to avoid rupturing them and dissipating the contaminated carbon materials. They should be placed into tightly covered containers until they can be recycled or properly disposed of.
- ✓ Carbon beds used for VOC removal from the extracted vapor should be properly managed and disposed of in compliance with Subtitle C regulations, and should meet all applicable land disposal standards. If the carbon is regenerated using steam or other means, the residual contaminated liquids should be managed as hazardous wastes, and treated or disposed of in compliance with the applicable regulations.
- ✓ Containers that hold residual liquids should be stored where they cannot be disturbed or ruptured by large equipment. This may require construction of a residuals management unit separate from the treatment and storage areas.

- ✓ All dusts or other particulates that are collected during emissions control activities should be tested for contamination levels and handled and disposed of properly.
- ✓ Air stripping or other treatment of extracted (contaminated) water/liquids should meet all applicable surface water discharge standards for post-treated water.
- ✓ When residual treatment wastes are obtained in the form of pure listed waste/liquids (e.g., condensate from steam regeneration of carbon beds), the recycling/reuse option for such residual waste should be considered.

2.3 References

1. National Oceanographic and Atmospheric Administration (NOAA). 1995. Comparative Climatic Data for the United States through 1994, U.S. Department of Commerce, Asheville, NC, October.
2. USEPA. 1993. Approaches for the Remediation of Federal Facility Sites Contaminated with Explosive or Radioactive Wastes, EPA/625/R-93/013, Office of Research and Development, Washington, DC, September.
3. USEPA. 1991. Engineering Bulletin, Control of Air Emissions from Materials Handling During Remediation, EPA/540/2-91/023, Office of Research and Development, October.

3.0 Chapter Three: CROSS-MEDIA TRANSFER CONTROL TECHNOLOGIES and MONITORING

This chapter provides descriptions of some of the technologies and practices that are available to control or treat releases that might create cross-media contamination during implementation of treatment technologies for soils and/or solid media. These control technologies should generally be applied under the following conditions:

- When potential for cross-media transfer exists associated with the use of a soil treatment technology as identified in Chapters 4 through 10 of this document.
- When recommended in the general best management practices (BMPs) section (Chapter 2) or technology-specific BMPs (Chapters 4 through 10).
- When a safe exposure level for workers is exceeded during cleanup activities, as determined by the Occupational Safety and Health Administration (OSHA), per 29 CFR part 1910.
- Any other site-specific reasons that warrant their application, such as proximity of a populated area or a drinking water source to the site.

3.1 Available Control Technologies

Information contained in this chapter is mostly provided in the following five tables:

Table 3-1. Emissions Sources and Controls During Cleanup Activities. This table lists potential emissions sources that may be encountered during cleanup activities such as containers, tanks, and landfills. It describes some common controls that can be used to reduce those emissions, and outlines factors that may contribute to the likelihood of emissions from those sources.

Table 3-2. Technologies for Controlling Cross-Media Transfer of Contaminants During Materials Handling Activities. This table lists materials handling activities that may be performed during site preparation and staging, as well as pre- and post-treatment, that have the potential to create cross-media contamination. It provides control technologies that can be used during those activities, and lists factors that may influence the effectiveness of those control technologies. Some of the controls listed in this table may be applicable to treatment activities which are discussed in the individual remediation technology chapters.

Table 3-3. Technologies for Reducing Contaminant Concentrations in Air Emissions Generated During Remediation. This table provides a list of control technologies that can be used to reduce the concentrations of air emissions. It describes each technology, and

outlines factors that may influence the effectiveness of those control technologies.

Table 3-4. Examples of Technologies for Controlling Cross-Media Transfer to Water. This table provides a list of controls that should be considered during all remedial activities to minimize the potential for releases from soil to surface and/or ground water. The examples provided are for relatively small-scale structures that can be applied to short-term projects; for larger-scale and long-term projects, consult the Metropolitan Washington Council of Governments document cited in the references.

Table 3-5. Examples of Field Monitoring Technologies. This table provides a list of technologies or practices that can be used to monitor potential emissions during remediation activities. It describes the technologies that can be used to monitor emissions from active and inactive sites. These technologies can be applied prior to and during remediation, as needed. A few simple and easy-to-use monitoring techniques are also listed in this table.

Table 3-1. Emissions Sources and Controls During Cleanup Activities (USEPA, 1992a)

Emission Source	Description of Control Technology	Factors Affecting Emissions
Surface Impoundments	<p><u>Air-Supported Structures</u> are made of light materials (often plastics, vinyls, or coated fabrics) that form a roof-like structure over the impoundment. Fans are used to maintain positive pressure to inflate the structure. For effective control, the air vented from the structure should be sent to a control device such as a carbon adsorber. Air supported structures have been used as enclosures for conveyors, open top tanks, and storage piles, as well as impoundments.</p> <p><u>Floating Membrane Covers</u> are used to cover large impoundments containing liquids. The membrane must provide a seal at the edge of the impoundment, and provisions must be made for the removal of rainwater that accumulates on the covers. Additionally, vent systems for the removal of accumulated gases and pumping systems for the removal of accumulated sludge may be necessary.</p>	<ul style="list-style-type: none"> • Volatility of constituent • Residence time • Surface area • Turbulence • Windspeed • Temperature • Extent of competing mechanisms (e.g., biodegradation)
Tanks	<p><u>Fixed Roofs</u> can be retrofitted to open tanks, or a fixed-roof tank can be used to replace an open tank or impoundment. Compared to an open tank, a fixed roof tank can provide additional control of 86 to 99 percent.</p> <p><u>Floating Roofs</u> are common on tanks at petroleum refineries. The roof floats on the liquid and moves with changes in the liquid level, controlling working losses. Floating roofs can be installed internally in a fixed-roof tank or externally in a tank without a fixed roof. Emissions from a properly maintained floating roof are very low.</p>	<ul style="list-style-type: none"> • Volatility of constituent(s) • Surface area • Turbulence • Windspeed • Temperature

Table 3-1. Emissions Sources and Controls During Cleanup Activities (cont'd) (USEPA, 1992a)

Emission Source	Description of Control Technology	Factors Affecting Emissions
Dewatering Devices	Dewatering devices, such as rotary drums and presses, provide several opportunities for volatile organics to be emitted, such as when a press is opened to remove and transport accumulated sludge, or during pressing, when volatile liquids may leak from a press into a drip pan underneath. Emissions from dewatering devices can be controlled by building an <u>enclosure</u> around the unit and venting it to a <u>control device</u> (best used for presses or rotary devices), or by collecting volatile organics in a <u>condenser</u> above the volatile source, treating the waste, and discharging it as appropriate (best for thin-film evaporators). In addition, sludge fixation often generates volatiles during mixing, when agitation is provided while adding the fixative agent. Emissions during fixation can be controlled by installing <u>covers or enclosures</u> that are vented to a control device.	<ul style="list-style-type: none"> • Temperature • Surface area • Turbulence • Windspeed • Concentration • Volatility
Containers	<u>Submerged Fill Piping</u> has been shown to decrease emissions by 65 percent relative to splash filling. In submerged filling, an influent pipe is inserted below the existing liquid surface in the container. Liquid is introduced into liquid, rather than spilled on top of the liquid surface, which reduces splashing and the degree of saturation of the displaced vapors.	See Tanks
Landfills	<u>Carbon Adsorption</u> , <u>Condensation</u> , <u>Absorption</u> , or <u>Vapor Combustion</u> are traditionally used to capture and control emissions.	See Table 3-3 for descriptions of air control technologies

Table 3-2. Technologies for Controlling Cross-Media Transfer of Contaminants During Materials Handling Activities (USEPA, 1991)

Remedial Activity	Description of Control Technology	Factors Influencing Effectiveness
All	<p><u>Operational Controls:</u> Those procedures or practices inherent to most site remediation projects that can be instituted to reduce VOC and particulate matter emissions. You should, to the extent possible:</p> <ul style="list-style-type: none"> ✓ Plan site remediation for times of year with relatively cooler temperatures and lower wind speeds to minimize volatilization and particulate matter emissions. ✓ Maintain lower speeds with all vehicles on unpaved roads. ✓ Control placement and shape of storage piles. Place piles in areas shielded from prevailing winds. Shape pile in a way that minimizes surface area exposed to wind. ✓ During excavation, use larger equipment to minimize surface area/volume ratio of material being excavated. ✓ During dumping, minimize soil drop height onto pile, and load/unload material on leeward side of pile. ✓ During transport, cover or enclose trucks transporting soils, increase freeboard requirements, and repair trucks exhibiting spillage due to leaks. 	
Excavation	<p><u>Covers and Physical Barriers:</u> Physically isolate the contaminated media from the atmosphere. Include soils (topsoils or clays); organic solids such as mulch, wood chips, sawdust, or straw, typically anchored with a net; asphalt/concrete; gravel/slag with road carpet; synthetic covers (e.g., tarps). Some technologies best used in active areas, others in inactive areas; see USEPA 1992b for details.</p>	Site characteristics (terrain, vegetation, nature of contaminated media) and needs for access
	<p><u>Foam Coverings:</u> "Blanket" the emitting source with foam, thus forming a physical barrier to emissions. Also insulate emitting source from wind and sun, further reducing particulate and volatile emissions. Several commercially available. Generally used in active areas.</p>	Drainage rates, wind speed, precipitation, surface roughness, temperature, surface activity, contaminant characteristics

Table 3-2. Technologies for Controlling Cross-Media Transfer of Contaminants During Materials Handling Activities
(cont'd)

(USEPA, 1991)

Remedial Activity	Description of Control Technology	Factors Influencing Effectiveness
	<p><u>Wind Screens</u>: Provide an area of reduced velocity that allows settling of large particles and reduces particle movement from exposed surfaces on leeward side of screen. Also reduce soil moisture loss due to wind, resulting in decreased VOC and particulate emissions.</p>	<p>Wind screen porosity, wind direction with respect to screen, wind screen height, soil silt content</p>
	<p><u>Slurry Cover Sprays</u>: Spray soil piles/excavated areas with a thin layer composed of a fibrous slurried aggregate that hardens to form a protective layer (see Sec. 11.6.2 for an example of commercially available materials).</p>	
Excavation (cont'd)	<p><u>Water Sprays</u>: Agglomerate small particles with larger particles or with water droplets. Also, water added to the soil cools the surface soil and decreases air-filled soil porosity, both of which reduce VOC emissions.</p>	<p>Application rate, application frequency, meteorological conditions, traffic rate</p>
	<p><u>Water Sprays with Additives</u>: Common additives include hygroscopic salts, bitumens, adhesives and surfactants. Reduce emissions by adsorbing moisture from the air, thereby increasing the soil moisture content; agglomerate surface soil particles to form a surface crust; or reduce water surface tension, thereby increasing wetting capacity of the water.</p>	
	<p><u>Enclosures</u>: Usually self-supported or air-supported structures; for soil storage piles, usually self-supported structures similar to the "beehive" used to store road salts. Provide a physical barrier between the emitting area and the atmosphere.</p>	<p>Potential for enclosure materials to react with contaminants</p>
Transportation	<p><u>Covers and Physical Barriers</u>: Road carpets are water permeable polyester fabrics that are placed between the road bed and a coarse aggregate road ballast, such as gravel, across which vehicles travel. Creates a physical barrier between moving vehicles and source of emissions.</p>	

Table 3-2. Technologies for Controlling Cross-Media Transfer of Contaminants During Materials Handling Activities
(cont'd)

(USEPA, 1991)

Remedial Activity	Description of Control Technology	Factors Influencing Effectiveness
	<p><u>Covers on Loads</u>: Cover all loads being moved by truck, open piping, or other conveyance with tarps, roofs, or other structures that will eliminate or reduce the likelihood of particulate release into the atmosphere.</p>	
	<p><u>Water Sprays of Active Areas</u>: See Excavation</p> <p><u>Dust Suppressants</u>: See Excavation</p>	
Dumping	<p><u>Water Sprays</u>: Water can be sprayed in a curtain-like fashion over the bed of a truck (or over any conveyance system, such as a moving belt) during dumping; see Excavation for details on how water sprays work</p> <p><u>Water Sprays with Additives</u>: Used like water sprays (see above), with additional substances such as surfactants; see Excavation</p>	
Preparation of Contaminated Media and Feeding Media into Remediation System	<p><u>Covers and Physical Barriers</u>. See Excavation</p> <p><u>Enclosures</u>. See Excavation</p> <p><u>Collection Hoods</u>: Commonly used in small areas (e.g., waste stabilization/solidification mixing silos, bioremediation reactors) and route those emissions to air pollution control devices. Capture emissions by creation of an air flow after the emitting source that is sufficient to remove the contaminated air.</p>	Distance between hood and emissions source; volumetric flow rate into hood; surrounding air turbulence; hood design

Table 3-2. Technologies for Controlling Cross-Media Transfer of Contaminants During Materials Handling Activities
 (cont'd)

(USEPA, 1991)

Remedial Activity	Description of Control Technology	Factors Influencing Effectiveness
Storage of Waste/Residuals	<p><u>Covers and Physical Barriers</u>: See Excavation</p> <p><u>Foam Coverings</u>: See Excavation</p> <p><u>Wind Screens</u>: See Excavation</p> <p><u>Water Sprays</u>: See Excavation</p> <p><u>Water Sprays with Additives</u>: See Excavation</p>	

**Table 3-3. Technologies for Reducing Contaminant Concentrations in Air Emissions Generated During Remediation
(USEPA, 1995 and 1992b)**

Technology	Description	Factors Influencing Effectiveness
<u>Incineration</u>		
-- Catalytic (also known as <i>catalytic oxidation</i>)	Contaminant-laden waste gas is heated with auxiliary fuel to between 600° and 900°F. The waste gas is then passed across a catalyst where the VOC contaminants react with oxygen to form carbon dioxide and water. (USEPA, 1992b)	Waste gas composition
-- Regenerative Thermal	Contaminated air is preheated, then combusted to oxidize the organic volatiles. The clean gas exiting the combustion chamber is cooled by passing through cool packed beds, then discharged to the atmosphere. Remaining contaminated air is reheated, then passed through packed beds, with clean air cooled and discharged. The cycle of heating, cooling, and discharge is repeated as necessary. (USEPA, 1995)	Useful for low concentrations of VOCs at low to moderate feed rates
<u>Adsorption</u>	Organics are selectively collected on the surface of a porous solid. Typical adsorbents include activated carbon, silica and aluminum-based adsorbates. (USEPA, 1995)	Must be used in conjunction with units that recover or destroy organic volatiles
-- Nonregenerable	Air stream containing volatiles flows upward through one or two fixed beds of adsorbent. Volatiles are adsorbed until breakthrough occurs, at which time adsorbent is replaced. (USEPA, 1995)	At high influent concentrations, not generally cost-effective because of large volumes of adsorbent that must be used
-- Modified	Systems designed specifically for low concentrations (less than 100 ppm) of organic volatiles in gas, which most treatment systems are not designed to accommodate. Adsorption treatment is followed by treatment of the concentrated volatiles in the regenerated gas (by incineration), or volatiles below regulatory limits are discharged into atmosphere. (USEPA, 1995)	

**Table 3-3. Technologies for Reducing Contaminant Concentrations in Air Emissions Generated During Remediation (cont'd)
(USEPA, 1995 and 1992b)**

Technology	Description	Factors Influencing Effectiveness
-- Fabric Filter	Designed for control of particulate emissions from point sources. One or more isolated compartments containing rows of fabric bags or tubes. Particle-laden gas passes up along the surface of the bags then radially through the fabric. Particles are retained on the upstream face of the bags, while the clean gas stream is vented to the atmosphere. (USEPA, 1992b)	Flue gas temperature, gas stream composition, particle characteristics
-- High Efficiency Particulate Air Filter (HEPA)	Used at sites requiring 99.9% or greater particulate removal. Can be used as a particulate matter polishing step in ventilation systems for enclosures or with solidification/stabilization mixing bins. (USEPA, 1992b) Comprised of a series of filters, filter housing, duct work, and a fan. Filters are aligned in series, in parallel, or in a combination. Air is forced over the filters; larger particulates are collected on prefilters, finest particulates are collected on filters. When breakthrough occurs, filters are replaced and disposed of.	Moisture content of contaminated air stream; degree of particulate matter loading
<u>Absorption</u>	Organics in the gas stream are dissolved in a solvent liquid, such as water, mineral oil, or other nonvolatile petroleum oil. The contact between the absorbing liquid and the vent gas is accomplished in counter current spray towers, scrubbers, or packed or plate columns. In most cases, the volatiles are stripped from the scrubbing liquid; the volatiles are then recovered as liquids by a condenser. (USEPA, 1995)	Works better at higher volatile concentrations
<u>Other Commercial Technologies</u>		
-- Enhanced Adsorption	Combines wet scrubbing, carbon adsorption, and ozone reactions; ultimately all organic volatiles are oxidized to carbon dioxide, water, and if chlorine is present in the contaminated air stream, hydrochloric acid. (USEPA, 1995)	Periodic replacement/regeneration of saturated filter media provides smooth and effective operation

**Table 3-3. Technologies for Reducing Contaminant Concentrations in Air Emissions Generated During Remediation (cont'd)
(USEPA, 1995 and 1992b)**

Technology	Description	Factors Influencing Effectiveness
-- Internal Combustion Engines	Uses a conventional automobile or truck internal combustion engine as a thermal incinerator of contaminated gas streams. (USEPA, 1992b)	Optimum air/fuel mixture for complete combustion
-- Membranes	Membrane concentrates organic solvents by being more permeable to organic constituents than to air. A pressure difference is imposed across a selective membrane (with a compressor or vacuum), which drives the separation of the solvent from the gas stream. The stripped-off gas is either vented or recycled to the source of contamination. (USEPA, 1992b)	Solvent permeability (flux across the membrane), separation factor (degree of concentration the membrane can achieve)
-- Condenser	Volatile components of a vapor mixture are separated from the remaining gas by a phase change. Condensation occurs when the partial pressure of the volatile components is greater than or equal to its vapor pressure, which can be achieved by lowering the temperature or increasing the pressure of the gas stream. (USEPA, 1992b)	Characteristics of vapor stream, condenser operating parameters
-- Wind Screens	Provide limited control of VOC emissions by increasing the thickness of the laminar film layer (stagnant boundary layer) on the leeward side of the screen; also reduce soil moisture loss to wind, resulting in decreased VOC emissions. (USEPA, 1992b)	Wind screen porosity, wind direction with respect to wind screen, wind screen height, soil silt content
<u>Emerging Technologies</u>		
-- Corona Discharge	Uses a high voltage/low current electrical charge to destroy a wide range of molecules in a gas stream containing organic volatiles. (USEPA, 1995)	

**Table 3-3. Technologies for Reducing Contaminant Concentrations in Air Emissions Generated During Remediation (cont'd)
(USEPA, 1995 and 1992b)**

Technology	Description	Factors Influencing Effectiveness
-- Heterogeneous Photocatalysis	Uses a near-ultraviolet light to continuously activate a semiconductor (such as titanium dioxide). The activated surface of the semiconductor then acts as a catalyst for the oxidation of the organic volatiles in air. (USEPA, 1995)	Possibly contaminant concentrations (incomplete reactions when concentrations are high); humidity (high humidity may reduce effectiveness)
-- Biofiltration	Offgases containing biodegradable organic compounds are vented, under controlled temperature and humidity, through a biologically active material. The microorganisms contained in the bed of compost-like material digest or biodegrade the organics to carbon dioxide and water. (USEPA, 1995)	

Table 3-4. Examples of Technologies for Controlling Cross-Media Transfer to Water

Technology	Description	Purpose
Temporary Diversion	A temporary ridge or excavated channel or combination ridge and channel constructed across sloping land on a predetermined grade (USDA, 1995)	Protects work areas from upslope runoff and to divert sediment-laden water to an appropriate sediment trapping facility or stabilized outlet
Filter Berms	A temporary ridge of gravel or crushed rock constructed across a graded right-of-way (EPA, 1972)	Retains sediment on-site by retarding and filtering runoff while at the same time allowing construction traffic to proceed along the right-of-way. Used primarily across graded rights-of-way that are subject to vehicular traffic. Also applicable for use in drainage ditches prior to roadway paving and establishment of permanent ground cover.
Infiltration Basins	Impoundments where incoming stormwater runoff is stored until it gradually exfiltrates through the soil of the basin floor. Removal of pollutants is accomplished by adsorption, straining, and microbial decomposition in the basin subsoils as well as the trapping of particulate matter within pretreatment areas. (MWCOG, 1992)	Collects sediments and pollutants
Temporary Sediment Traps	Small, temporary ponding basins formed by construction of an embankment or excavated basin (USDA, 1995)	Detains sediment-laden runoff from small disturbed areas for a sufficient period of time to allow the majority of sediment and other floating debris to settle out
Diversion Dikes	A combination of ridge and excavated channel constructed to divert surface flow	Diverts overland flow from certain areas away from unstabilized or contaminated areas (USDA, 1995)

Table 3-4. Examples of Technologies for Controlling Cross-Media Transfer to Water (cont'd)

Technology	Description	Purpose
Riprap	A combination of large stones, cobbles and boulders used to line channels, stabilize banks, reduce runoff velocities, or filter out sediments (MWCOG, 1992)	Prevents erosion on steep or cleared slopes (USDA, 1995)
Sand Filters	A filtration system constructed of layers of peat, limestone, and/or topsoil, and may also have a grass cover crop. The first flush of runoff is diverted into a self-contained bed of sand. The runoff is then strained through the sand, collected in underground pipes and returned to the stream or channel. (MWCOG, 1992)	Treats stormwater runoff; removal rates for sediments and trace metals are high, and moderate for nutrients, BOD, and coliform

Table 3-5. Examples of Field Monitoring Technologies (Freeman and Harris, 1995, and USEPA, 1994)^a

Technique	Description and Application to Air Emissions	Applicable To¹	Types of Detectors Commonly Used²
Direct Measurement with Hand-Held Equipment	Hand-held organic vapor analyzers provide quick readings on presence of organic vapors. Can be used to check for emissions from specific equipment (e.g., pipe seals, gaskets), or to identify when emissions levels change from one area to another.	VOCs, some SVOCs	OVA
Head Space Analysis	Involves collecting waste material in a bottle with "significant" head space and allowing the waste/head space to reach equilibrium. The head space gas is then analyzed for volatile compounds with simple real time analyzers.	VOCs, SVOCs	OVA, PID for VOCs and SVOCs
Realtime Instrument Survey	Screening takes place directly over the waste to obviate modeling by testing the air above the surface. This approach can identify "hot spots" of emissions and zones of similar emissions.	VOCs, SVOCs, PM	OVA, PID for VOCs and SVOCs; DM for PM
Upwind/Downwind Survey	Monitors upwind/downwind concentrations of ambient target compounds. Often, realtime analyzers with flame ionization and photoionization detection are used for organic emission detection.	VOCs, SVOCs	OVA, PID for VOCs and SVOCs; DM for PM; GC/MS
Surface Flux Chamber	A direct measurement approach applicable to many kinds of waste sites and capable of generating both undisturbed and disturbed emission rate data for volatile and semivolatile compounds. The technology uses a chamber to isolate a surface emitting gas species (organic or inorganic); emission rates are calculated by measuring the gas concentration in the chamber and using the chamber sweep air flow rate and surface area.	VOCs, SVOCs, PM	OVA, PID for VOCs and SVOCs; SD, GC/MS

Table 3-5. Examples of Field Monitoring Technologies (cont'd)
(Freeman and Harris, 1995, and USEPA 1994)^a

Technique	Description and Application to Air Emissions	Applicable To¹	Types of Detectors Commonly Used²
Transect	An indirect method that involves the collection of ambient concentration data for gaseous compounds and/or particulate matter using a two-dimensional array of point samplers. These data, along with micro-meteorological data, can be used to estimate the emission rate of the source by using a dispersion model. Data can be obtained that represent emissions from a complex or heterogeneous site or an activity that generates fugitive air emissions.	VOCs, SVOCs	Fourier Transform Infrared Optical Remote Sensing Detector; Ultraviolet-Differential Optical Absorbance Sensor; Filter Band Pass Absorption Detector, Laser, PAS
Visual Inspection	Periodic visual inspection of pipes and joints for corrosion and leaks could provide early detection and prevent major leaks or spills.	Liquids and gases	Occasionally aided by hand-held telescopes, or magnifying glass.
Periodic Watershed Evaluation	The impact of cleanup activities on the watershed could be periodically evaluated by monitoring the following indicator parameters: <ul style="list-style-type: none"> • Level of siltation • Water clarity • Habitat and vegetation <p>Most of the above monitoring could be accomplished by visual inspections.</p>	Water and sediment	

^a For details on screening survey, monitoring instruments, limitations of portable VOC detection devices, performance criteria of VOC detectors, data handling, and calibration procedures, see cited reference -- USEPA, 1994, pages 37-47.

¹ VOCs = Volatile Organic Compounds; SVOCs = Semi-Volatile Organic Compounds; some volatile inorganic compounds are amenable to techniques suitable for SVOCs; and PM=Particulate Matter.

² OVA = Organic Vapor Analyzer; PID = Photoionization Detector; SD = Specific Compound Detector; DM = Dust Monitor; and GC/MS = Gas Chromatography/Mass Spectrometry

3.2 Relative Costs of Implementing BMPs

EPA did not conduct an exhaustive analysis of the costs associated with implementing the practices outlined in this document. Conducting such an analysis is complicated by two key factors: (1) many of the suggested practices do not involve equipment purchases nor do they entail a well-defined or discrete task outside the integral remediation activities, and (2) cost data available on soil cleanups tend to be aggregated such that costs for performing specific practices are not discernable. In addition, the practices applicable or necessary for a particular cleanup, and the magnitude to which they are performed, can vary based on the characteristics of the site and those of the contaminants present.

Notwithstanding, as a general rule, EPA does not expect cleanup managers to incur a significant incremental cost in implementing the practices suggested in this document. In fact, at many sites, cleanup managers are already implementing the applicable practices as part of the good management practices they follow whenever performing cleanups. The costs of implementing these practices are subsumed into their overall cleanup costs. EPA recognizes that, in some cases, additional costs may be incurred to implement cross-media transfer controls. However, in these cases, these costs would probably need to be incurred anyway to meet existing state or federal cleanup requirements or to avert potential future costs to address cross-media transfers of contaminants. Based on preliminary cost data gathered during field validation of BMPs, these costs are generally an integral part of the cost of remedial activity and are estimated to comprise about two to six percent of the overall cleanup cost.

EPA welcomes any data that will help to more fully characterize the costs related to minimizing cross-media transfers of contaminants.

Although actual cost figures are not available at this time for the recommended BMPs, studies have been conducted earlier by EPA on the relative cost effectiveness for point source VOC controls as shown in Figure 3-1 (USEPA, 1992b).

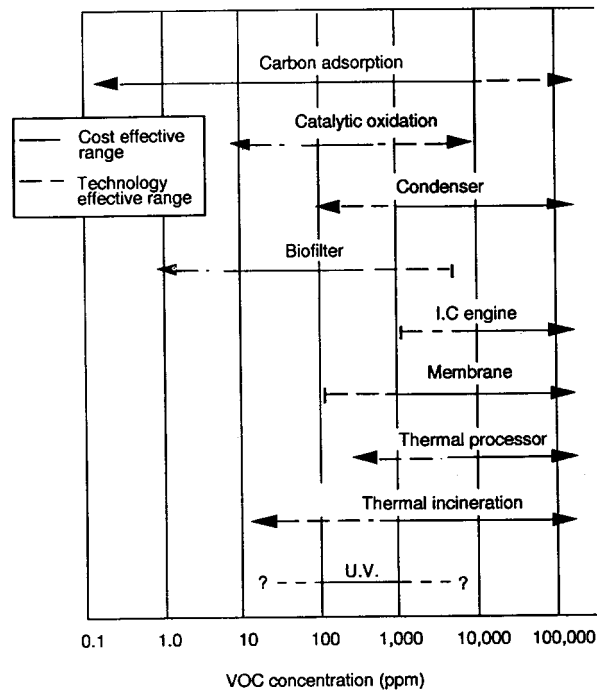

Figure 3-1. Relative Cost Effectiveness for Point Source VOC Controls (USEPA, 1992b)

3.3 References

1. USDA. 1995. Illinois Urban Manual - a technical manual designed for urban ecosystem protection and enhancement, prepared for Illinois Environmental Protection Agency, by the U.S. Department of Agriculture (USDA), Natural Resources, Conservation Service, Champagne, Illinois.
2. USEPA. 1995. Survey of Control Technologies for Low Concentration Organic Vapor Gas Streams, EPA/456/R-95/003, Office of Air Quality Planning and Standards, Research Triangle Park, May.
3. Freeman, Harry M. and Eugene F. Harris. 1995. Hazardous Waste Remediation: Innovative Treatment Technologies, Technomic Publishing Co., Inc., Lancaster, PA.
4. USEPA. 1994. Control Technologies for Fugitive VOC Emissions from Chemical Process Facilities, Handbook, EPA/625/R-93/005, Office of Research and Development, Cincinnati, March.
5. USEPA. 1992a. Seminar Publication, Organic Air Emission from Waste Management Facilities, EPA/625/R-92/003, Office of Air Quality Planning and Standards, Research Triangle Park, August.

6. USEPA. 1992b. Control of Air Emissions from Superfund Sites, EPA/625/R-92/012, Office of Research and Development, November.
7. Metropolitan Washington Council of Government (MWCOG). 1992. A Current Assessment of Urban Best Management Practices, a report prepared for U.S. EPA's Office of Wetlands, Oceans, and Watersheds, March.
8. USEPA. 1991. Engineering Bulletin, Control of Air Emission from Materials Handling During Remediation, EPA/540/2-91/023, Office of Research and Development, October.
9. USEPA. 1989. Seminar Publication, Corrective Action Technologies and Applications, EPA/625/4-89/020, Office of Research and Development, Cincinnati.
10. USEPA. 1988. Project Summary. Fugitive Dust Control Techniques at Hazardous Waste Sites: Results of Three Sampling Studies to Determine Control Effectiveness, EPA/540/S2-85/003.
11. USEPA. 1972. Guidelines for Erosion and Sediment Control Planning and Implementation, EPA-R2-72-015, Office of Research and Development, August.

4.0 Chapter Four: BMPs for CONTAINMENT TECHNOLOGIES

This chapter focuses on the generally accepted best management practices (BMPs) to minimize cross-media transfer of contaminants during remedial actions or corrective measure implementations when using containment technologies to treat soils or solid media. BMPs are meant only to provide guidance and general recommendations on the operational practices of selected technologies. BMPs are not meant to direct or dictate the selection of appropriate technologies.

4.1 Definition and Scope of Containment Technologies (for BMPs)

Containment technologies use physical barriers to retain, immobilize, or isolate contaminated media from the surrounding environment and to minimize migration of the contaminants without destroying them.

Many types of containment technologies are currently being used for soils treatment or disposal. Considering their similarity in cross-media transfer potentials, the following treatment technologies are listed as a few examples of containment technologies (for the purpose of BMPs):

- Storage Piles/Vapor Sheds
- Storage Containers/Drums
- Tank Installations
- Impoundments
- Siltation Basins
- Slurry Walls
- Salt Bed Disposal
- Geomembrane Barriers
- Landfill Cover Systems
- Landfill Liner Systems

The scope of BMPs for containment technologies is not limited to the above listed technologies. Any treatment technology that meet the key features of containment technologies, as described below, should generally be considered as containment technologies for the purpose of BMPs.

Diagrams of two typical containment technologies are shown in Figures 4-1 and 4-2. Details of most of the above technologies are provided in the cited references (USEPA, 1992a and 1993a, and Rumer and Ryan, 1995). The salt bed disposal system used at the Waste Isolation Pilot Plant (WIPP) is a unique containment technology designed for the safe disposal radioactive wastes (DOE, 1995).

4.1.1 Key Features of Containment Technologies for the Purpose of BMPs

- Do not destroy contaminants.
- Immobilize contaminants.
- Provide temporary storage and containment of wastes.
- Provide barriers that contain the waste and control horizontal and/or vertical movement of contaminants. Typical construction uses either soil-bentonite or cement-bentonite mixtures.
- Provide partial barriers that control infiltration of precipitation, thereby reducing the amount of leachate generated as

the water passes through the waste. The systems consequently reduce horizontal and downward migration of contaminants.

- Reduce contaminant movement upward and prevent the waste from physical contact with the surface water.

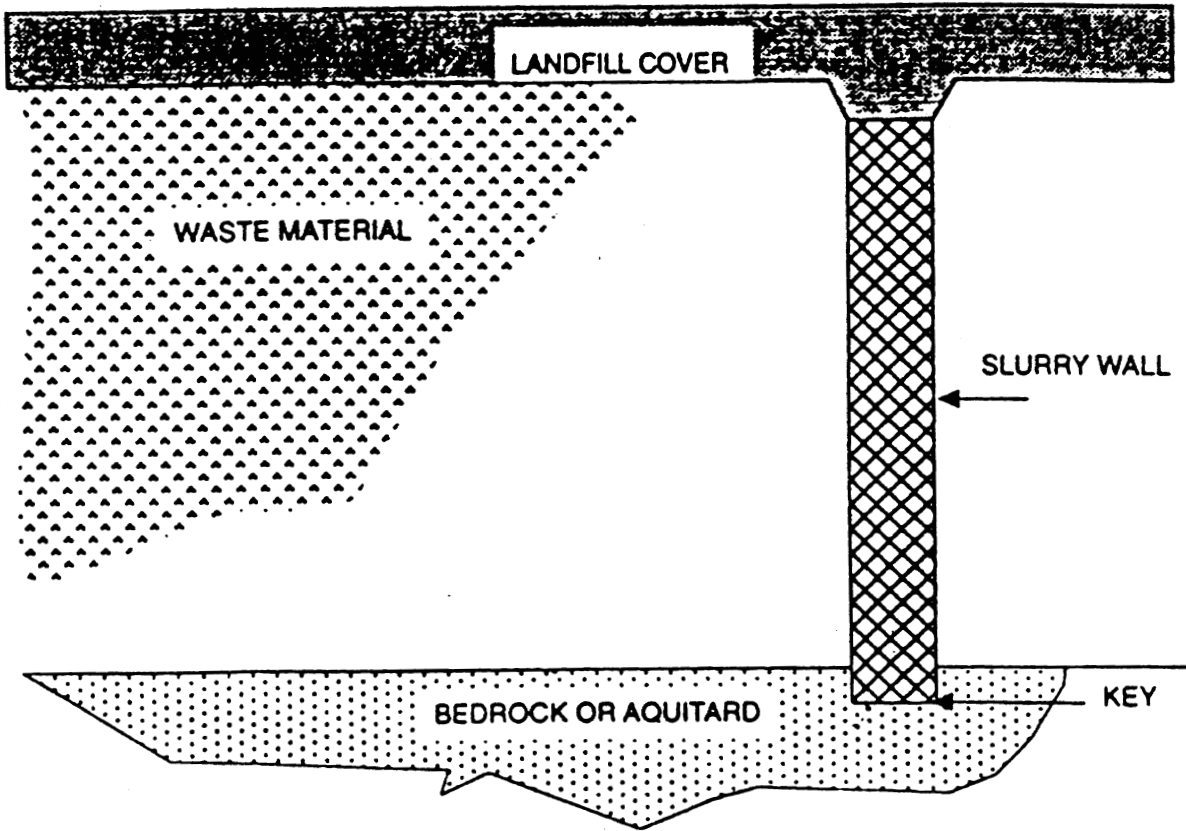

Figure 4-1. Cross-Sectional View Showing Implementation of Slurry Walls (USEPA, 1992a)

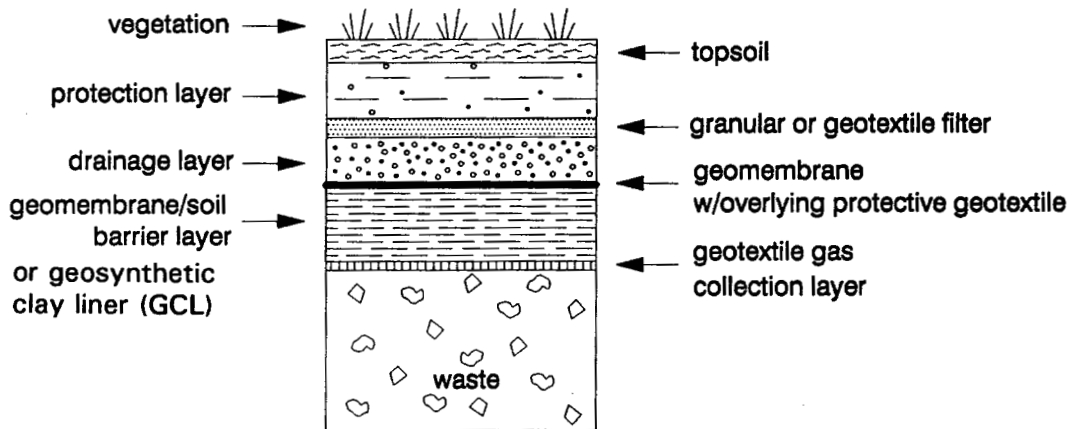

Figure 4-2. Cross-Section of Multilayer Landfill Cover (USEPA, 1993a)

4.2 Containment Technology Description

Although many different technologies fall within the umbrella of the containment technology group, the two most commonly encountered at present are slurry walls and landfills. A brief description of slurry walls and landfill cover systems are provided here. These technologies often require an extensive preparation of the site (e.g., geotechnical characterization and reinforcement of existing subsurface structures at the site before constructing a slurry wall) and/or pretreatment of the waste being contained (e.g., excavation and removal of highly contaminated waste from the site before constructing a landfill cover system).

The construction of slurry walls involves the excavation of a vertical trench using a bentonite-water slurry to hydraulically shore up the trench during construction and seal the pores in the trench walls via formation of a "filter-cake." A cross-sectional view of a slurry wall is shown on Figure 4-1. Slurry walls are usually 20 to 80 feet deep with widths from 2 to 3 feet (USEPA, 1992a). Depending on the site conditions and contaminants, the trenches can be either excavated to a level below the water table to capture chemical "floaters" (this is termed as a "hanging wall") or extended ("keyed") into a lower confining layer (e.g., bedrock or aquitard). Similarly, on the horizontal plane the slurry wall can be constructed around the entire perimeter of contaminated media or portions thereof (e.g., upgradient or downgradient). The principal distinctions among slurry walls are differences in the low-permeability materials used to backfill the trenches, namely the water content and ratios of bentonite/soil or bentonite/cement used to backfill the trench. In most cases using bentonite/soil, the excavated soil is mixed with bentonite outside the trench. A relatively new development in the construction of slurry walls is the use of mixed in-place walls (also referred to as soil-mixed walls). This method of vertical barrier construction is recommended for sites where soft soils are encountered, there are concerns for failure of traditional trenches due to hydraulic forces, or space availability for construction equipment is limited (USEPA, 1992a).

Grouting, including jet grouting, employs high pressure injection of a low permeable substance into fractured or unconsolidated geologic material. This technology can be used to seal fractures in otherwise impermeable layers or construct vertical barriers in soil through the injection of grout into holes drilled at closely spaced intervals (i.e., grout curtain).

The design of landfill covers is also site-specific and depends on the intended functions of the system. Many natural, synthetic and composite materials and construction techniques are available. Covers can range from a one-layer system of vegetated soil to a complex multi-layer system. A cross-sectional view of a typical multilayer landfill cover is given in Figure 4-2. Generally a fill layer of clean soils is placed first above the waste and graded to establish the base of the cover system. Then, a bottom layer, which may be a granular gas collection layer, is placed on top of the fill layer as a base for the remainder of the cover. The barrier layer is installed next. The materials used in the construction of the barrier layer are low-permeability soils and/or geosynthetic clay liners (GCLs). A flexible membrane liner (FML) layer is placed on top of the low-permeability barrier layer. These two layers prevent water infiltration into the waste. The high permeability drainage layer is placed on top of FML to drain the water

away that percolates through the top of the cover. A granular or geotextile filter fabric may be laid on top of the drainage layer for protecting the drainage layer from clogging due to fine silts or clay deposits from the percolating water. A protective fill soil and topsoil are then applied and the topsoil seeded with grass or other vegetation adapted to local conditions. Covers are usually constructed in a crowned or domed shape with side slopes as low as is consistent with good stormwater runoff characteristics. Other materials may be used to increase slope stability. Steeply mounded landfills can have a negative effect on the construction and stability of cover. For example, there may be difficulty anchoring a geomembrane to prevent it from sliding along the interfaces of the geomembrane and soils.

Landfill covers are presently constructed in a variety of combinations depending upon the site-specific conditions. The most critical components of a cover with respect to selection of materials are the barrier layer and the drainage layer. The barrier layer can be a GCL and/or low-permeability soil (clay). Other alternative barrier materials have also been identified in the document (USEPA, 1993a) cited under reference.

4.3 Cross-Media Transfer Potential of Containment Technologies

(a) General

General cross-media transfer potentials during site preparation, pre-treatment, and post-treatment activities have been addressed in Chapter 2.

(b) Additional Concerns for Specific Containment Technologies

In addition to the general concerns and BMPs that are outlined in Chapter 2, containment technologies pose the following technology-specific concerns:

- Geomembranes are vulnerable to puncturing during installation. Inadequate preparation of the surface on which the geomembrane will be laid, or improper placement of materials on top of the geomembrane may result in punctures that allow infiltration of water and escape of volatile contaminants. Proper seaming of adjacent sheets also is critical for effective containment using this technology (Rumer and Ryan, 1995).
- Landfill cover systems pose the same cross-media transfer potential as geomembrane liners. Breaches in the system's integrity could allow infiltration of rain water. The infiltration could then result in leaching of contaminants from the waste into surrounding soil and underlying groundwater. VOCs may also escape from the landfill cover system by diffusion through the cover layers and by "barometric pumping" through vents (USEPA, 1992c). Breaches in the landfill cover system and improper design and installation of landfill gas collection systems also could allow volatile contaminants to escape into the atmosphere.

- Since salt bed disposal is a deep underground entombment of contaminants, potential for releases are minimal. However, improper storage and handling of the wastes before placing them in the deep underground vaults could cause aboveground migration of contaminants.

4.4 Best Management Options to Avoid Potential Cross-Media Transfers for Containment Technologies

General BMPs to prevent potential cross-media transfer of contaminants during site preparation, pre-treatment, and post-treatment activities have been addressed in Chapter 2. Only technology-specific treatment activities and possible BMP options to control cross-media transfer of contaminants during these activities are furnished below.

Containment Treatment Activities - During implementation of the containment technologies the following activities are most commonly undertaken:

- ◆ Excavation; trenching; storage of soils, sediments, and materials that will be used to construct containment system; construction of slurry walls, landfill covers, and other containment units. In the case of deep containment, such as with salt beds, extensive underground excavation is required. Secondary activities include surface water diversion and control, on-site pumping and treating, installation of cut-off trench type interceptors, installation of leachate collection systems.

During these activities, the following BMPs should be considered for containment technologies:

- ✓ In the case of slurry walls, when there is a potential for outward migration and contamination of groundwater, periodic pumping and treating of the contaminants from the contained area and maintaining an inward hydraulic gradient from outside to inside the slurry wall may be considered. This practice has been observed in the field during field validation of BMPs (see Section 11.7.1).
- ✓ All soils should be analyzed and processed before they are disposed of off-site (see Section 11.7.2).
- ✓ Air quality trends should be constantly monitored. If air quality degrades as a result of construction activities, those activities should be altered or stopped until air quality is restored (see Section 11.7.2).
- ✓ Climatological extremes (e.g., high wind) should be considered when implementing containment technologies. See Chapter 2, Section 2.2.2, for details on consideration of climatological extremes.
- ✓ All debris should be covered during construction (see Section 11.7.2).

- ✓ Temporary sumps should be used to collect stormwater runoff from the site during construction (see Section 11.7.2).
- ✓ Temporary arrangements should be provided that protect areas that are vulnerable to damage and migration of contaminants during construction (e.g., road covers). See Chapter 3 and Section 11.7.2 for more details.
- ✓ Effective VOC, methane, and odor emissions should be controlled by using covers, foam suppressants, enclosures, vapor collection systems, gas flares, or other methods as appropriate (USEPA, 1992b).
- ✓ Contaminated liquids generated from treatment operations should be treated and/or disposed in a protective manner as specified in Chapter 3 and Chapter 6, Section 6.4, of this document.

Additional Post-Treatment Activities - In addition to the general post-treatment BMPs provided in Chapter 2, the following BMPs should be considered for containment technologies:

- ✓ Routine audits should be conducted to verify the integrity of the containment structure with accompanying documentation.
- ✓ For most containment technologies, the production of residuals is generally not a concern. However, construction of soil-bentonite slurry walls can generate large quantities of excess slurry and excavated materials. In most cases, it is expected that these excess materials are not hazardous (Freeman and Harris, 1995). However, if the excavated soil and slurry cannot be used as backfill, they should be properly stored onsite or transported and disposed offsite.

4.5 Waste Characteristics that May Increase the Likelihood of Cross-Media Contamination for Containment Technologies

The effectiveness of containment technologies could be compromised and undue cross-media contamination may be caused under certain conditions identified in this subsection. However, some of these limitations could possibly be overcome with various technology specific modifications and variations. Please refer to technology-specific references provided at the end of this chapter for additional information about modifications or variations that can be used to enhance the effectiveness of containment technologies.

- ▶ When contaminant concentrations exceed 10% to 25% of their explosive limits, they are potentially unsafe to handle or can pose a threat to the integrity of the containment system (USEPA, 1994).
- ▶ Ignitable wastes may present fire hazards when treated using containment technologies that are exothermic (generates heat).

- ▶ Very low pH values (<4.0 Standard Unit (SU)) or high (> 11 SU) may lead to corrosion in liners and equipment (USEPA, 1994).
- ▶ Strong oxidizers can corrode slurry walls and geomembranes.

4.6 References

1. Freeman, Harry M. and Eugene F. Harris. 1995. Hazardous Waste Remediation: Innovative Treatment Technologies. Technomic Publishing Co., Inc., Lancaster, PA.
2. Rumer, R.R. and M.E. Ryan. 1995. Barrier Containment Technologies for Environmental Remediation Applications, John Wiley and Sons, Inc., August.
3. U.S. Department of Energy (DOE). 1995. Draft No Migration Variance Petition, Waste Isolation Pilot Plant, DOE/CAO-95-2043, Carlsbad Area Office, Carlsbad, NM. May.
4. USEPA. 1994. BMP Development Workshop Summary - Containment Technologies. Office of Solid Waste, Permits and State Programs Division, August.
5. Dutta, S. 1993. Modified Cover System for Hazardous Waste Landfills in Semi-Arid Areas, Proceedings of the 3rd International Conference on Case Histories in Geotechnical Engineering, St. Louis, MO, June.
6. USEPA. 1993a. Engineering Bulletin-Landfill Covers. EPA/540/S-93/500. Office of Research and Development, Cincinnati, February.
7. USEPA. 1993b. Environmental Fact Sheet, Controlling the Impacts of Remediation Activities in or Around Wetlands, EPA/530/F-93/020, Office of Solid Waste and Emergency Response/Office of Waste Programs Enforcement, August.
8. USEPA. 1992a. Engineering Bulletin-Slurry Walls, EPA/540/S-92/008, Office of Research and Development, Cincinnati, October.
9. USEPA. 1992b. Engineering Bulletin, Control of Air Emissions from Materials Handling During Remediation, EPA/540/2-91/023, October.
10. USEPA. 1992c. Organic Air Emissions from Waste Management Facilities, EPA/625/R-92/003, May.
11. USEPA. 1991a. Handbook, Stabilization Technologies for RCRA Corrective Actions, EPA/625/6-91/026, Office of Research and Development, Washington, DC, August.
12. USEPA. 1991b. SITE Technology Demonstration Summary, International Waste Technologies/Geo-Con In Situ Stabilization/Solidification Update Report, EPA/540/S5-89/004a, Center for Environmental Research Information, Cincinnati, OH.

13. USEPA. 1989. Technical Guidance Document, Final Covers on Hazardous Waste Landfills and Surface Impoundments, EPA/530/SW-89/047, Office of Solid Waste and Emergency Response, Washington, DC.

5.0 Chapter Five: BMPs for SOIL WASHING

This chapter focuses on the generally accepted best management practices (BMPs) to minimize cross-media transfer of contaminants during remedial actions or corrective measure implementations when using soil washing technologies to treat soils or other solid media. BMPs are meant only to provide guidance and general recommendations on the operational practices of selected technologies. BMPs are not meant to direct or dictate the selection of appropriate technologies.

5.1 Definition and Scope of Soil Washing (for BMPs)

Soil washing (for BMPs) is an ex situ, generally water-based process that relies on traditional chemical and physical extraction and separation processes for removing a broad range of organic, inorganic, and radioactive contaminants from soils or solid media (USEPA, 1993a). This aqueous-based technology uses mechanical processes (e.g., scouring) and/or solubility characteristics of contaminants to separate contaminants from excavated soils or solid media. The process frees and concentrates contaminants in a residual portion of the soil (typically 5 to 40% of the original volume), where they can be subsequently treated by other remediation techniques or managed in compliance with applicable regulations.

A typical schematic of a soil washing system is shown on Figure 5-1.

Because of their similarity in cross-media transfer potentials the following treatment technologies are listed as a few examples of soil washing technologies (for the purpose of BMPs):

- Soil Washing
- Solvent Extraction
- Debris Washing
- Magnetic Separation
- Excavating, Dredging, and Conveying
- Wet and Dry Screening
- Gravity Concentration
- Froth Flotation

The scope of BMPs for soil washing is not limited to the above listed technologies. Any treatment technology that satisfies the key features of soil washing could be considered as soil washing technologies for the purpose of BMPs. BMPs for soil flushing technologies and other in situ technologies are addressed under Chapter 10 of this document. Solvent extraction has been included in this chapter because the treatment process closely matches the key features of this BMP category.

5.1.1 Key Features of Soil Washing Technology for the Purpose of BMPs

- A non-destructive process which separates contaminants from solids and concentrates the contaminants for collection and/or treatment.
- An ex situ technique normally requiring excavation of soil or sediment and other materials handling operations, such as pre-

screening of oversize (e.g., vegetation, debris, etc.), stockpiling, conveying, and particle size separation.

- Applicable for treating a wide variety of organic, inorganic, and radioactive contaminants in soil or solid media.
- Commonly relies on additives such as surfactants or solvents to enhance the effectiveness of the soil washing process.
- Significantly reduces the volume of contaminated soil (USEPA, 1992a).

5.2 Soil Washing Technology Description

A synopsis of the technology description is provided here. For detailed information on this technology see the relevant references cited in this chapter.

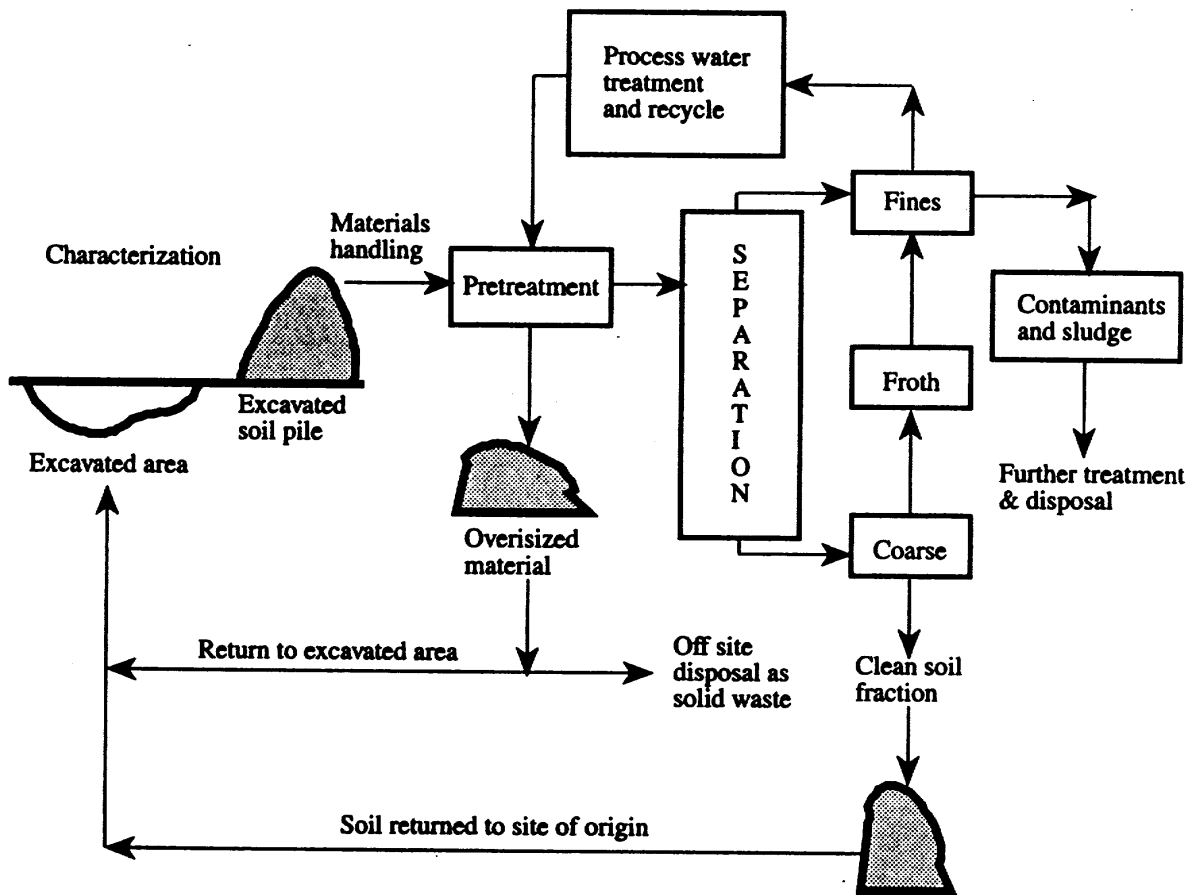

Figure 5-1. Basic Soil Washing Flow Diagram (USEPA, 1993a)

The soil washing process begins with the excavation and preparation of the feedstock soil. Soil preparation can involve the mechanical screening of the feedstock

to remove rocks, debris, and other oversized material (USEPA, 1993a). The treatment process generally involves the use of wet, mechanical scrubbing and screening processes to separate particles containing the contaminants. Most commercially available soil washing systems utilize mechanical screening devices to remove oversized materials and separation systems to generate coarse- and fine-grained fractions. The process also includes treatment units for washing and systems for scrubbing the separated fractions. The specific processes and equipment used depend upon individual site characteristics.

After excavation and preparation, the feedstock soil is actively mixed with water or an amended water-based washing fluid, which separates the contaminants from the soil. The soil is then separated from the spent fluid, and the soil is recovered in two distinct fractions. One fraction comprises a relatively high volume, coarse sand and gravel fraction that is clean and suitable for use as on-site fill; the other usually comprises a smaller volume, fine silt and clay fraction that typically carries the bulk of the contaminants. From the coarse soil fraction, a contaminated, naturally occurring organic material may be separated as a third fraction by specific gravity separation. The coarse sand and gravel fraction is generally passed through an abrasive scouring or scrubbing action to remove the surficial contamination. The washwater in this washing step may contain a basic leaching agent, surfactant, or chelating agent to help remove organics or heavy metals. The mixture is agitated by use of high-pressure water jets, vibration devices, and other means depending upon the equipment (USEPA, 1991a). Fine particles are sometimes further separated in a sedimentation tank with the help of a flocculating agent.

In the final step, the remaining fine silt, clay and the contaminated washwater are treated. The contaminated washwater may require precipitation and clarification, which removes metals and fine soils as a sludge. The fine soils, in which contaminants have been concentrated, will normally require further treatment or proper disposal in compliance with applicable regulations.

To increase the efficiency of contaminant removal, sometime chemical agents are added to the washwater. Acids, such as hydrochloric acid, sulfuric acid, and nitric acid, may be added to improve the solubility of certain contaminants, especially heavy metals. Sodium hydroxide, sodium carbonate, and other bases can be used to precipitate contaminants in the extraction fluid. Dispersion of oily contaminants can be facilitated by the addition of surface active agents. Various chelating agents such as citric acid, ammonium acetate, nitrilotriacetic acid (NTA), and ethylenediaminetetraacetic acid (EDTA) will remove the available fraction of inorganic contaminants (USEPA, 1991a). For improved removal in certain cases, the extraction temperature is elevated or an oxidizer, such as hydrogen peroxide, or ozone is added for chemical oxidation.

5.3 Cross-Media Transfer Potential of Soil Washing Technologies

(a) General

General cross-media transfer potentials during site preparation, pre-treatment, and post-treatment activities have been addressed in Chapter 2.

(b) Additional Concerns for Soil Washing Technologies

- Additives used in the process can increase the potential of direct spillage of wastewater (e.g., foam with metals and organics) to the soil and surface water during treatment activities, especially if soil washing unit is not properly lined and bermed.
- In the specific case of solvent extraction, where there are commonly pressurized tanks and flammable and highly volatile solvents used, there is potential for VOC emissions due to leaks in pipes, joints, and valves. Major emission points associated with solvent extraction are those involved in the distillation process used to recover the solvent (USEPA, 1992b).
- Chelating agents, surfactants, solvents, and other additives are often difficult and expensive to recover or recycle from the spent washing fluid by conventional treatment processes, such as, settling, chemical precipitation, or activated carbon. The presence of additives in the contaminated soil and treatment sludge residuals may cause added difficulty in disposing of these residuals (USEPA, 1993a), thereby increasing the potential for cross-media transfer.
- Additives used in the soil washing, debris washing, wet screening and froth flotation process can increase the potential of direct spillage of wastewater to the soil and surface water during treatment activities as a direct result of excessive foaming or frothing.
- Soil characterization data (e.g., size classifications, levels of contamination, permeability of soil, and estimates of the quantities of soil) used for treatability or pilot-scale tests may not accurately reflect the breadth of soil characteristics actually found in the field. Accurate characterization is important for the efficient use of this technology and additional pretreatment of the soil (i.e., additional drying, crushing and sizing) may be necessary just prior to operating the technology. Such improper characterization or lack of adequate pre-treatment may lead to a higher potential for cross-media transfer than expected.
- Treated soil residues from soil washing, wet and dry screening, gravity concentration and froth flotation may have significantly different soil characteristics such as permeability and compactability, and thus, could adversely effect the ground water flow characteristics of the site where these soils are replaced. Other constituents at the site could then migrate back into or through the treated soil.
- Wastewaters from soil washing, wet screening, froth flotation and debris washing may contain diluted amounts of the hazardous constituents and significant levels of suspended matter. Cross-

media transfer can occur if these residues are released to the environment without any treatment.

- Improper or incomplete identification of contaminants and lack of knowledge of their concentrations in the spent washwater may foul up the system since the washwater is treated and recycled back into the washing process. This may in turn cause inadequate cleaning and removal of contaminants and cause cross-media transfer.
- When the fine particles are not separated from the pre-treated soils, it may result in emission of the fine particles, which oftentimes bind most of the contaminants.

5.4 Best Management Options to Avoid Potential Cross-Media Transfers for Soil Washing Technologies

General BMPs to prevent potential cross-media transfer of contaminants during pre-treatment and post-treatment activities have been addressed in Chapter 2. Only technology specific treatment activities and possible BMP options to control cross-media transfer of contaminants during treatment, as well as a few post-treatment BMPs, are furnished below.

During the soil washing treatment process, the following activities are most commonly undertaken:

- ◆ Excavation of soils, temporary storage, particle size separation, transportation/transfer of contaminated soils from loaders to dump trucks, mixing action, movement of the contaminated media through a conveyor system, desorption, separation, and washing in an aqueous media.

The following BMPs, when appropriate, are recommended to prevent cross-media transfer of contaminants for the above activities:

- ✓ Precautions should be taken to avoid foaming (or frothing) and subsequent overflow by periodically performing visual inspections when additives are used that have been demonstrated to froth in other situations. Field testing of small soil samples in jars with excess additives might help anticipate problems, but should not be used as the only means to anticipate frothing problems. As a contingency plan, the area underneath the soil washing unit could also be lined and bermed to collect any potential spillage.
- ✓ Major emission points associated with solvent extraction, such as, those involved in the distillation process for recovering solvent, should be carefully monitored during operation. Process shutdowns may be deemed necessary if excessive levels are detected.
- ✓ Volumes of soil batches should be carefully managed so that they do not overflow the containers or exceed the normal operating specification of the

equipment. The soil batches should preferably be run at less than maximum capacity to prevent leaks or spills.

- ✓ Chelating agents, surfactants, solvents, and other additives should be carefully selected so as to avoid ones that are difficult and expensive to recover or treat by conventional processes, such as, settling, chemical precipitation, or activated carbon. Potential impact of residual soil washing additives that are anticipated to remain in the soil after treatment should be examined and replacement plans be adjusted accordingly (e.g., if acids are used to extract metals from soils, the residual soil may need to be either limed prior to replacement in order to account for the acidity expected to be left in the soil or a neutralization step may need to be included as part of the soil washing process.)
- ✓ Any off-site runoff should generally be prevented from entering and mixing with the on-site contaminated media by building earthen berms or adopting similar other measures. Provision should be made to capture the on-site surface water runoff by diverting it to a controlled depression-area or lined pit.
- ✓ Most soil washing operations are vulnerable to high wind, especially with respect to the fugitive dust emission. Weather monitoring and operational control should be exercised as specified in Chapter 2 of this document. During excavation and material handling activities as well, meteorological conditions should be strongly emphasized and evaluated to minimize cross-media transfer.
- ✓ Mixing, crushing, or conveying activities should generally be conducted under an environment where the off gases, volatiles, dusts, etc. are all captured inside a hood or cover or controlled using other control options listed in Chapter 3. The VOC emissions associated with these activities should be controlled by capturing and then treating the captured vapor/air.
- ✓ All excavated soils when stored prior to treatment should be securely covered with plastic liners and these temporary covers need to be maintained until the storage pile is moved for treatment. The excavated cells should also be lined, when migration possibilities of contaminated runoff exist, during precipitation events.
- ✓ During the main treatment activities as specified above, organic or inorganic vapor emissions should be monitored and appropriate emission control measures, described in Chapter 3 of this document, should be used to prevent emissions above the allowable level specified by the regulatory agency (EPA or authorized state).
- ✓ When treating soils contaminated with explosive wastes, proper safety and care should be exercised to prevent any explosion during the treatment process. For conducting safe operations, recommendations provided in the Handbook (USEPA, 1993c) may be used, when necessary.

- ✓ Periodic system monitoring and evaluation should be performed, if appropriate, to prevent leaks or spills.

- ✓ When re-using treated soils for restoration of a site, care should be taken to re-create the original soil texture. The anticipated soil characteristics of the treated soil should be verified prior to replacement. This may require the addition of clays, nutrients, or other materials, some of which can be mixed in from clean soils at the site. During these soil mixing activities, BMPs for pre-treatment should be applied (i.e., use covers over areas used for storage or mixing or for processing small batches; minimize work in high temperatures or in high wind, etc.).

- ✓ There are four main waste streams generated during soil washing: contaminated solids from the soil washing unit, wastewater, wastewater treatment sludges and residuals, and air emissions (Freeman and Harris, 1995). General BMPs for addressing these residuals are provided in Chapter 2; additional BMPs are provided here.
 - When collecting moisture or liquids from the treatment process, the contaminated aqueous stream should generally be collected in a tank or a lined/containment system. This should prevent the contaminants from mixing with the normal surface water runoff from the area and the surrounding natural watercourse. The contaminated aqueous stream should be treated or disposed of in accordance with the applicable regulation.

 - An enclosed conveyance system, such as a pipeline or hose, should be used to move contaminated liquids from the soil washing unit to the containers that will be used to store them.

 - Containers that hold residual liquids should be stored in a place in which they cannot be disturbed or ruptured by large equipment. This may require construction of a residuals management unit separate from the treatment and storage areas.

 - During post-treatment, residuals that are nearly pure listed waste (contaminant) or highly concentrated may need to be managed. These wastes should be dealt with extreme caution and safety to avoid all possible risks of cross-media transfer of contaminants and treated or disposed of in compliance with the applicable state and/or federal regulations.

 - Wastewaters containing the hazardous constituents and the high levels of suspended matter can generally be treated with conventional wastewater technologies to acceptable regulatory levels. They should generally be handled on-site as potentially hazardous wastewaters with appropriate spill prevention contingencies. Air emissions from these units should also be

evaluated for appropriate control measures (i.e., closed tanks, covers, etc.) as specified in Chapter 3.

- If solid materials such as granulated carbon filters are used, they should be removed carefully from the emissions system to avoid rupturing them and dissipating the carbon materials. They should be placed into tightly covered containers until they can be recycled or properly disposed of.

5.5 Waste Characteristics that May Increase the Likelihood of Cross-Media Contamination for Soil Washing Technologies

The effectiveness of soil washing treatment technologies could be compromised and undue cross-media contamination may be caused under certain conditions identified in this subsection. Some soils, especially those that are rich in clays or contain high concentrations of mineralized metals or hydrophobic organics, require very large amounts of additives to achieve acceptable remediation endpoints. Additionally, complex mixtures of contaminants in the soil may make it difficult to formulate a single suitable washing fluid that will remove all the different contaminant types. In such cases, multiple cleaning fluids may need to be used, and therefore multiple types of residuals will be generated.

When soil washing is used to remediate contaminated soil, one should consider the potential for the generation of large amounts of hazardous wastes that must be treated or disposed of (sometimes at a great cost) when this technology is used in less than ideal situations. In such cases, even when best management practices are applied, the significant volumes of hazardous wastes that are generated and the reduced efficiency with which the overall system is operating can increase the risk of accident or mismanagement, which can in turn increase the risk of cross-media contamination.

However, some of these limitations could possibly be overcome with various technology specific modifications and variations, and some of these limitations could possibly be overcome by coupling with other processes (such as further separation of fines, using special solvents, etc.), but may involve higher cost. The following few characteristics have been identified that could impede the soil washing treatment process and may result in cross-media transfer of contaminants.

- ▶ Soils with high silt and clay content (>50% clay and silt) may be problematic due to the difficulty of removing contamination from very fine particles (Lear, 1996, and USEPA, 1993a).
- ▶ Soils contaminated with a high concentration of mineralized metals or hydrophobic organics (USEPA, 1993a).
- ▶ Complex mixtures of contaminants make it difficult to formulate a suitable washing fluid that will remove all the different contaminant types, and possibly be cost prohibitive. Sometimes a single contaminant/compound could also become strongly bound and difficult to remove (USEPA, 1993a).

- ▶ Generally not designed for highly explosive materials.

5.6 References

1. Lear, Paul R. 1996. OHM Remediation Services Corp. Comments on Draft BMP Document. Personal Communication with Subijoy Dutta, May.
2. U.S. Department of Energy (DOE). 1995. Draft No Migration Variance Petition, Waste Isolation Pilot Plant, DOE/CAO-95-2043, Carlsbad Area Office, Carlsbad, NM, May.
3. Freeman, Harry M. and Eugene F. Harris. 1995. Hazardous Waste Remediation: Innovative Treatment Technologies, Technomic Publishing Co., Inc., Lancaster, PA.
4. USEPA. 1994a. BMP Development Workshop Summary-Soil Washing and Thermal Treatment, Office of Solid Waste, Permits and State Programs Division, August.
5. USEPA. 1994b. Engineering Bulletin-Solvent Extraction, EPA/540/S-94/503, Office of Research and Development, Cincinnati, April.
6. USEPA. 1993a. William C. Anderson, ed. Innovative Site Remediation Technology, Soil Washing/Soil Flushing, Volume 3, EPA 542/B-93/012, Office of Solid Waste and Emergency Response.
7. USEPA. 1993b. Proposed Best Demonstrated Available Technology (BDAT) Background Document for Hazardous Soil, Office of Solid Waste, Waste Management Division, August.
8. USEPA. 1993c. Approaches for the Remediation of Federal Facility Sites Contaminated with Explosive or Radioactive Wastes, EPA/625/R-93/013, Office of Research and Development, Washington, DC, September.
9. USEPA. 1992a. A Citizen's Guide to Soil Washing-Technology Fact Sheet, EPA/542/F-92/003, Office of Solid Waste and Emergency Response, Technology Innovation Office.
10. USEPA. 1992b. Seminar Publication-Organic Air Emissions from Waste Management Facilities, EPA/625/R-92/003, Office of Research and Development, Washington, DC, August.
11. USEPA. 1991a. Guide for Conducting Treatability Studies Under CERCLA: Soil Washing, Interim Guidance (and Quick Reference Fact Sheet), EPA/540/2-91/020A and B, Office of Emergency and Remedial Response, September.
12. USEPA. 1991b. Innovative Treatment Technologies-Overview and Guide to Information Sources, EPA/540/9-91/002, Office of Solid Waste and Emergency Response, Washington, DC, October.

13. USEPA. 1990a. Engineering Bulletin-Solvent Extraction Treatment, EPA/540/2-90/013, Office of Research and Development, Cincinnati, September.
14. USEPA. 1990b. Engineering Bulletin-Soil Washing Treatment, EPA/540/2-90/017, Office of Research and Development, September.
15. USEPA. 1989. Overview: Soils Washing Technologies for CERCLA, RCRA, and Leaking UST Site Remediation, Risk Reduction Engineering Laboratory, Edison, NJ, June.

6.0 Chapter Six: BMPs for THERMAL TREATMENT

This chapter focuses on the generally accepted best management practices (BMPs) to minimize cross-media transfer of contaminants during remedial actions or corrective measure implementations when using thermal treatments to treat soils or solid media. BMPs are meant only to provide guidance and general recommendations on the operational practices of selected technologies. BMPs are not meant to direct or dictate the selection of appropriate technologies.

6.1 Definition and Scope of Thermal Treatment (for BMPs)

Thermal treatment processes employ indirect or direct heat exchanges to desorb, vaporize, or separate volatile or semi-volatile organics from soils or any solid media while largely avoiding combustion (destruction) of these contaminants in the primary unit. Gases or vapors from the thermal process are treated, destroyed or condensed for reuse. (USEPA, 1993a and 1994c)

Many types of thermal treatment technologies are currently being used for the treatment of soils and solid media. Considering their similarity in cross-media transfer potentials, the following treatment technologies are listed as a few examples of thermal treatment (for BMPs):

- Thermal Desorption
- Catalytic Oxidation
- Thermal Bonding
- Molten Salt Oxidation
- LT³ System
- Low Temperature Thermal Aeration
- Anaerobic Thermal (ATP)
- Rotary Desorbers
- Heated Conveyors
- Anaerobic Pyrolysis

Two technologies included in this group -- molten salt oxidation and anaerobic pyrolysis -- differ slightly from the others, but have been included here because they resemble these technologies more than any others addressed in this guidance. However, unlike the other technologies in this group, molten salt oxidation and anaerobic pyrolysis destroy at least some portion of the contaminants present in the soil or solid media.

The scope of BMPs for thermal treatment is not limited to the above listed technologies. Any treatment technology that meets the key features of thermal treatment should generally be considered as thermal treatment for the purpose of BMPs. BMPs for incineration technologies are addressed separately under Chapter 9 of this document.

A typical schematic of a thermal desorption system is shown in Figure 6-1.

6.1.1 Key Features of Thermal Treatment for the Purpose of BMPs

- External application of heat to raise the operating temperature is the unique feature of the thermal treatment category for the purpose of BMPs.

- Most thermal treatments call for operating temperatures that are significantly above ambient temperature and exceed the boiling point of water, i.e., 212°F.
- Most thermal treatments under this category are generally designed to remove contaminants from the soil matrix.
- These treatment technologies are generally designed to be non-destructive. But the high operating temperatures used in some thermal treatment systems will result in localized oxidation or pyrolysis (USEPA, 1994c).
- The desorption, vaporization, or separation of different contaminants from the soil matrix varies with the type of contaminants. These variations depend significantly on the type of contaminant and the selected operating temperature.
- The residence time, operating temperature, and the expanse of mixing/agitating the contaminated soil matrix or solid media are generally the prime operating factors in thermal treatment.

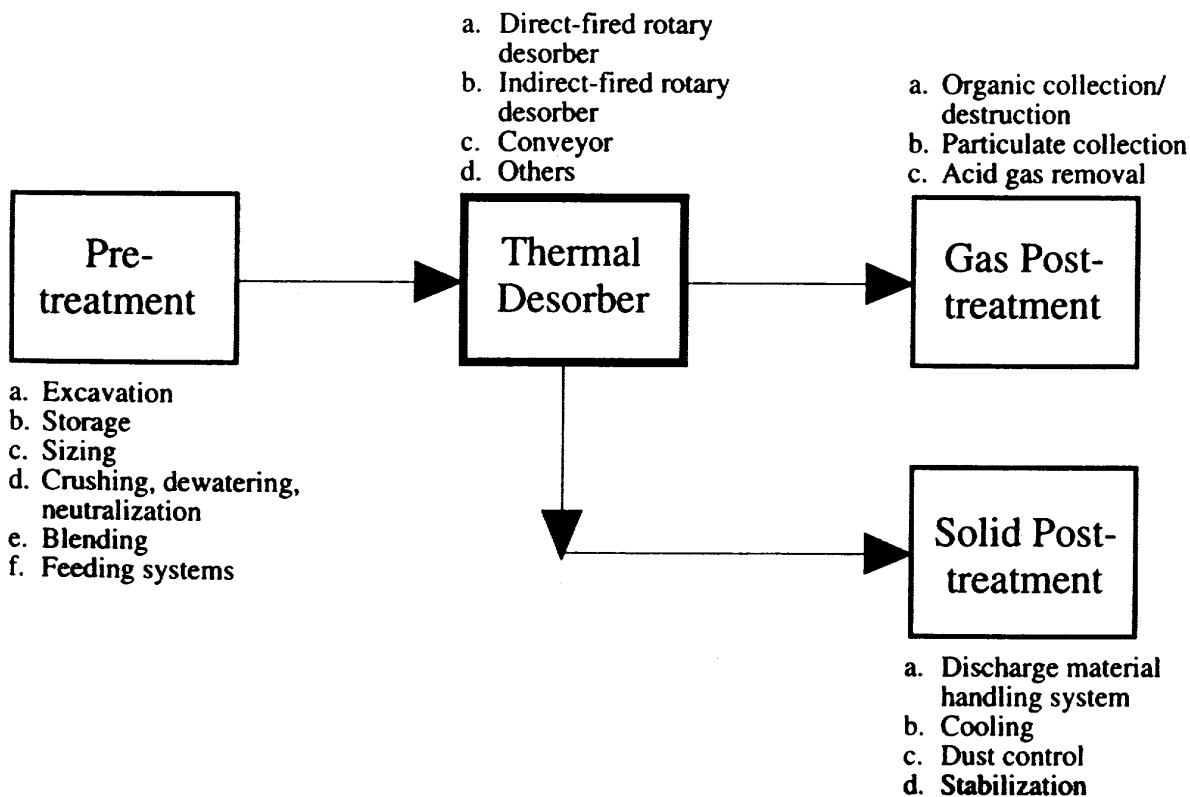

Figure 6-1. Schematic of a Thermal Desorption Treatment System (USEPA, 1993a)

6.2 Thermal Treatment Technology Description

Thermal desorption is considered the most general and representative form of thermal treatment for the purposes of this chapter; therefore, a description of thermal desorption is provided here.

In thermal desorption, contaminated material is excavated and delivered to the desorption unit. Excavated material is often stockpiled to provide an adequate feed supply for continuous operation of the treatment facility. Typically, before any treatment, large objects are screened from the medium and rejected. Rejected material can sometimes be sized and recycled to the desorber feed. The medium may then be treated to adjust pH and moisture content. The medium is then delivered by gravity to the desorber inlet or conveyed by augers to a feed hopper from which it is mechanically conveyed to the desorber. In the desorption unit, the contaminated material is heated, and water and contaminants are volatilized. An inert gas may be injected as a sweep stream. Organics in the off-gas may be collected and recovered by condensation and adsorption, or burned in an afterburner (USEPA, 1993a).

To increase the effectiveness of thermal desorption technology, extensive pre-processing/pre-treatment of the inlet soil may be conducted. This pre-processing may include removing rocks and debris from the waste matrix, mixing the waste to create a more homogeneous feed, and screening and crushing the waste matrix to achieve a smaller particle size. During pre-processing, air emission monitoring must be conducted to control fugitive emissions (USEPA, 1990).

Operation of thermal desorption systems can create a number of process residual streams that may need to be managed: treated media; untreated, oversized rejects; condensed contaminants and water; particulate control-system dust; clean off-gas; and spent carbon or other media, if used (USEPA, 1993a).

6.3 Cross-Media Transfer Potential of Thermal Treatment Technologies

(a) General

Environmental impacts associated with all thermal desorbers, aside from process emissions, are attributable to excavation of contaminated solids, management of treated solids, and equipment noise (USEPA, 1993a).

General cross-media transfer potentials during site preparation, pre-treatment, and post-treatment activities have been addressed in Chapter 2.

(b) Additional Concerns for Thermal Treatment Technologies

- During various thermal treatment operations, SVOC/VOC emissions can occur from leaks in pipes, joints, valves, and uncovered conveyor systems.

- Stack emissions from the collection or destruction of vapors past the thermal desorption, vaporization, or separation treatment unit can release contaminants into the air at levels above the regulatory limit.
- The discharge of scrubber liquor and blowdown can release contaminants to air, water, or soils.
- Waste handling can contribute significantly to VOC emissions during remediation of soils or solid media with thermal treatments.
- Inadequate control and management of baghouse dust containing ash, metals, and/or unoxidized compounds may also cause contaminants to be released into the environment.
- When using any thermal treatment for remediation of explosive wastes, there is potential for possible explosion or detonation of the waste during the treatment process.
- When radioactive/mixed wastes are remediated by thermal treatment, the radionuclides are generally retained or bonded and rendered unleachable for safe disposal of the solid residuals (e.g., ash) in landfills. Potential for radioactive emission from the treated mass may still exist.
- Fugitive emissions from fuel sources can sometimes add to the overall emissions of organics from the site.
- In cases where organic wastes are extracted or concentrated using a thermal treatment technology (i.e., rather than destroyed) the VOC emissions from these wastes can significantly increase the need for control of VOCs from the overall process.
- During remediation of chlorinated organics using the Anaerobic Thermal Processor or any other thermal treatment, the potential exists for the creation of dioxin or dibenzo-furans emissions at low concentrations. Fugitive VOC emissions from the vapor cooling system are also possible (USEPA, 1993a).

6.4 Best Management Options to Avoid Potential Cross-Media Transfers for Thermal Treatment Technologies

General BMPs to prevent potential cross-media transfer of contaminants during cleanup activities have been addressed in Chapter 2. Also, proper system design is recommended prior to implementation of the remedial treatment to avoid cross-media transfer problems during different treatment steps. However, BMP options to control specific cross-media transfer of contaminants for thermal treatments are furnished below.

During the thermal treatment process the following activities are most commonly undertaken:

- ◆ Application of heat in a heat exchanger unit; rotational or other mixing action; movement of the contaminated media through a conveyor system; vaporization, desorption, separation, or permanent bonding/solidification of contaminants.

To prevent cross-media transfer of contaminants the following BMPs are recommended, where appropriate:

- ✓ Fuel storage and fuel handling areas may be added under monitoring and emission control oversight if deemed necessary.
- ✓ Routine inspections of pipes, valves and fittings should be performed where fuel or pressurized liquids are involved.
- ✓ During the main treatment activities as specified above, organic or inorganic vapor emissions should be monitored and appropriate emission control measures, described in Chapter 3 of this document, should be used to prevent emissions above the allowable level specified by the regulatory agency (EPA or authorized state).
- ✓ Technology design should take corrosion into account and incorporate corrosion resistant surfaces for all appropriate pipes, valves, fittings, tanks, and feed systems. It is important that the air pollution control devices are designed for the corrosive nature of the hot gases expected to enter them. Operational plans should include adequate inspection procedures that look specifically for corrosion and wear.
- ✓ Operation of thermal desorption systems may create up to six process residual waste streams: treated soil; oversized soil and debris rejects; condensed contaminants and water; spent aqueous and vapor phase activated carbon; and clean off-gas. The following BMPs can be used to control the potential cross-media transfer of residuals:
 - Treated medium, debris, and oversized rejects may be suitable for reuse onsite. If not, they should be properly stored or containerized until they can be treated and disposed of.
 - The vaporized organic contaminants can be captured by condensation of the off-gas passing through a carbon absorption bed or other treatment system.
 - Liquid collection tanks and secondary containment should be incorporated into the operational plans. Plans should also be made for subsequent treatment of these concentrated liquids in appropriately regulated units.

- Aqueous wastes from scrubber liquors and blowdown could be effectively managed and controlled using a variety of wastewater treatment technologies. See USEPA, 1987, 1986, and 1984 for information on wastewater treatment technologies. Technology operational plans should incorporate discussions of how movement of these liquids will be adequately controlled.
- Off-gas condensate may contain significant contamination and may require further treatment (i.e., carbon absorption). If the condensed water is relatively clean, it may be used to suppress the dust from the treated medium.
- Spent granulated carbon should either be returned to the supplier for reactivation or incineration or regenerated onsite.
- ✓ System monitoring and evaluation should be performed, as appropriate, to determine possible emissions or migration of contaminants during treatment activities.

6.5 Waste Characteristics that May Increase the Likelihood of Cross-Media Contamination for Thermal Treatment Technologies

Under the following conditions the effectiveness of thermal treatment technologies (as categorized for the purpose of BMPs) could be compromised, and could cause undue cross-media contamination. However, some of these limitations could possibly be overcome with various technology specific modifications and variations.

- ▶ The contaminant concentration exceeding 10% to 25% of its lower explosive limit (USEPA, 1994a).
- ▶ Corrosion in containers and equipment due to low (< 5 Standard Unit (SU)) or high (>11 SU) pH may pose problems (USEPA, 1994c).
- ▶ Particles greater than 2 inches in diameter may call for separate treatment or disposal due to size limitations for most equipment used for thermal treatment systems (USEPA, 1994c).
- ▶ Very high moisture content (>50%) generally makes most thermal treatments highly cost intensive, and might increase the potential for cross-media release of contaminants through the vapor phase (USEPA, 1994c).
- ▶ Soils mixed with tars and organic materials greater than 10% by volume or weight may cause handling problems and thus may require use of a reactor or other equipment to process wastes, which could result in uncontrolled releases due to corrosion (USEPA, 1994c).

6.6 References

1. USEPA. 1995. In Situ Remediation Technology Status Report: Thermal Enhancements, EPA/542/K-94/009, Office of Solid Waste and Emergency Response.
2. USEPA. 1994a. BMP Development Workshop Summary for Soil Washing and Thermal Treatment, Office of Solid Waste, Permits and State Programs Division, August.
3. USEPA. 1994b. William C. Anderson, ed. Innovative Site Remediation Technology, Thermal Destruction, Volume 7, EPA 542/B-94/003, Office of Solid Waste and Emergency Response.
4. USEPA. 1994c. Engineering Bulletin-Thermal Desorption Treatment, EPA/540/S-94/501, Office of Research and Development, Cincinnati, February.
5. Air & Waste Management Association (AWMA). 1993. Thermal II Changing Molecular & Physical Status, AWMA Live Satellite Seminar.
6. USEPA. 1993a. William C. Anderson, ed. Innovative Site Remediation Technology, Thermal Desorption, Volume 6, EPA/542/B-93/011, Office of Solid Waste and Emergency Response.
7. USEPA. 1993b. Approaches for the Remediation of Federal Facility Sites Contaminated with Explosive or Radioactive Wastes, EPA/625/R-93/013, Office of Research and Development, Washington, DC, September.
8. USEPA. 1993c. Proposed Best Demonstrated Available Technology (BDAT) Background Document for Hazardous Soil, Office of Solid Waste, Waste Management Division, August.
9. USEPA. 1992a. Guide for Conducting Treatability Studies Under CERCLA: Thermal Desorption Remedy Selection, Interim Guidance (and Quick Reference Fact Sheet), EPA/540/R-92/074A and B, Office of Solid Waste and Emergency Response, September.
10. USEPA. 1992b. A Citizen's Guide to Thermal Desorption-Technology Fact Sheet, EPA/542/F-92/006, Office of Solid Waste and Emergency Response, Technology Innovation Office.
11. USEPA. 1991a. Innovative Treatment Technologies-Overview and Guide to Information Sources, EPA/540/9-91/002, Office of Solid Waste and Emergency Response, October.
12. USEPA. 1991b. Engineering Bulletin-Thermal Desorption Treatment, EPA/540/2-91/008, Office of Research and Development, Cincinnati, May.
13. USEPA. 1990. Handbook on In Situ Treatment of Hazardous Waste-Contaminated Soils, USEPA/540/2-90/002.
14. USEPA. 1988. Technology Screening Guide for Treatment of CERCLA Soils and Sludges, EPA/540/2-88/004.

15. USEPA. 1987. Dewatering Municipal Wastewater Sludges Manual, EPA/625/1-87/014, Office of Research and Development, Cincinnati, September.
16. USEPA. 1986. Municipal Wastewater Disinfection Manual, EPA/625/1-86/021, Office of Research and Development, October.
17. USEPA. 1984. Onsite Wastewater Treatment and Disposal Systems Manual, EPA/625/01-80/012, Office of Research and Development, October.

7.0 Chapter Seven: BMPs for VAPOR EXTRACTION

This chapter focuses on the generally accepted best management practices (BMPs) to minimize cross-media transfer of contaminants during remedial actions or corrective measure implementations when using vapor extraction technologies to treat soils or solid media. BMPs are meant only to provide guidance and general recommendations on the operational practices of selected technologies. BMPs are not meant to direct or dictate the selection of appropriate technologies.

7.1 Definition and Scope of Vapor Extraction (for BMPs)

Vapor extraction involves use of vacuum pumps or blowers to produce a negative pressure gradient, which induces air flow through the waste matrix and causes movement of vapors containing volatile organic compounds (VOCs) towards extraction wells. VOCs in the pore spaces of soils or solid media are thereby removed and carried above ground through screened extraction wells. Extracted vapors are treated, as necessary, and discharged to the atmosphere or reinjected to the subsurface (where permissible). (USEPA, 1995a and 1991d).

Because of their similarity in cross-media transfer potentials the following treatment technologies are listed as a few examples of vapor extraction technologies (for BMPs):

- Soil Vapor Extraction (SVE)
- Fracture Enhanced Vapor Extraction
- Thermal Enhancements of SVE
- Steam Injection
- Hot Air Injection
- In Situ Steam Stripping
- Soil Venting
- Bioventing (also in Chapter 8.0, Bioremediation)
- Air Sparging
- Multi-Phase or Dual-Phase Extraction

The scope of BMPs for vapor extraction is not limited to the above listed technologies. Any treatment technology that satisfies the key features of vapor extraction could be considered as vapor extraction for the purpose of BMPs.

Many of the above listed technologies are used in conjunction with vapor extraction or groundwater technologies, or may be used to remediate VOCs in saturated soils or groundwater. BMPs for bioventing systems are additionally addressed under Chapter 8 (BMPs for Bioremediation) of this document.

A typical schematic of a vapor extraction system is shown in Figure 7-1.

7.1.1 Key Features of Vapor Extraction Technology for the Purpose of BMPs

- With respect to vadose zone soils, vapor extraction relies on the ability to produce an advective air flow field throughout the contaminated soils.

- The vacuum gradient created induces air flow through vadose zone soils to volatilize contaminants.
- Transfers contaminants from soil to air. Vapor treatment following vapor extraction from the subsurface may be required to minimize discharge of contaminants to the atmosphere; however, it may not be required in all cases.
- Generally does not destroy contaminants; extracts contaminant vapors for collection and/or treatment.
- Effectively reduces concentrations of volatile organic compounds (VOCs) and certain biodegradable semi-volatile organic compounds (SVOCs). Less volatile contaminants may be removed by bioventing. Heat (hot air or steam) may be applied to increase the volatility of less volatile compounds (USEPA, 1995a).
- Generally, vapor extraction is an in situ technique (excluding above-ground vapor and water treatment). It is primarily designed for use in the vadose zone, although the saturated zone can be dewatered and treated or treated with air sparging combined with vacuum extraction.
- Vapor extraction can be used ex situ for the remediation of aboveground soil piles. For this application, perforated pipes are located within the aboveground soil piles and connected to a blower to draw air through the piles (USEPA, 1995a).

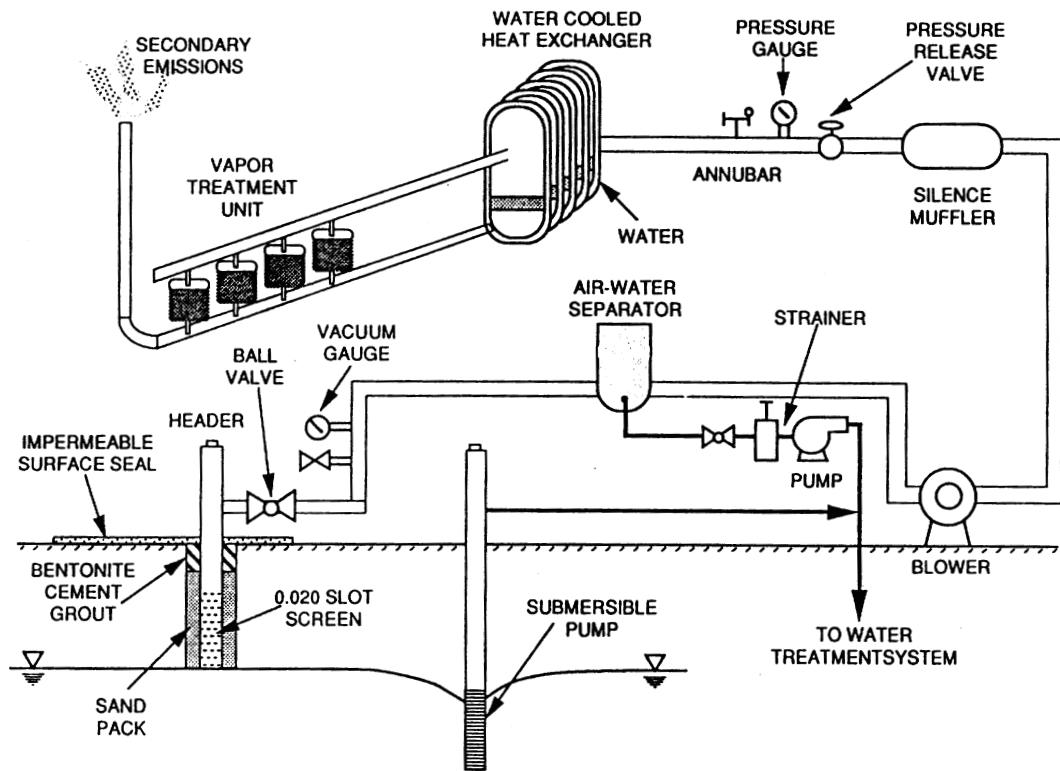

Figure 7-1. Schematic of a Soil Vapor Extraction System (USEPA, 1991d)

7.2 Vapor Extraction Technology Description

Vapor extraction processes couple vapor extraction wells with blowers or vacuum pumps to create an air-flow field in soil zones permeable to vapor flow. Contaminants volatilized within the air-flow field, are swept into the vapor extraction well and are removed from the soil. Vapor treatment systems, such as catalytic or thermal destruction systems, activated carbon adsorbers, or biological gas treatment systems may be employed to treat the extracted contaminated air stream (USEPA, 1995a).

Variants of vapor extraction, such as air sparging and thermally enhanced SVE, have been developed to extend the application of vapor extraction technology. Air sparging extends the application of vapor extraction to water-saturated soils by injecting air under pressure below the water table. Thermally enhanced SVE combines conventional vapor extraction equipment with a means to elevate the subsurface temperature for increasing the volatilization potential of the soil contaminants (USEPA, 1995a).

One advantage of vapor extraction systems is that they generally do not require addition of reagents that must be delivered to and subsequently recovered from the contaminated area (USEPA, 1990).

7.3 Cross-Media Transfer Potential of Vapor Extraction Technologies

(a) General

General cross-media transfer potentials during site preparation, pre-treatment, and post-treatment activities have been addressed in Chapter 2.

(b) Additional Concerns for Vapor Extraction Technologies

- Fugitive vapor emissions through surface soils during operation, especially when injection (air or steam) and fracturing technologies are applied.
- Operation of vapor extraction systems may result in the contaminated soil moisture becoming condensed and entrained with the system and/or cause the uptake of contaminated groundwater.
- Surface water can intrude or channel into the contaminated vadose zone altering the anticipated flow of vapors and groundwater.
- Undesirable migration of subsurface contaminant vapors or liquids into the soil due to improper design or operation. For instance, improper design of a vapor extraction system can cause unwanted migration of contaminants from source areas to virgin soils; improper design of an air sparging system can cause unwanted migration of dissolved phase and vapor phase contaminants to outside the remediation area.

- During vapor extraction system operation there is potential for VOC emissions through pipes, joints, and valves on the delivery/discharge side of the vacuum pump.
- Inadequate design and operation of emission control equipment may also cause transfer of contaminants to the natural environment.
- Residual contamination in the soil after system operation or beyond the effective zone of influence of the extraction wells can act as a continuing source of contamination to groundwater or air.
- Location and design of extraction and injection wells are critical to ensuring uniform distribution of subsurface air flow and that "dead" zones do not exist within the treatment area.
- With respect to injection techniques, underground sewer and utility conduits can cause short-circuiting of subsurface air flow, and may result in uncontrollable VOC discharges.
- Incomplete cleanup due to low permeability soil strata or units can occur. Subsurface air flow will follow the path of least resistance; therefore, channeling through more permeable soil zones (e.g., around natural gravel lenses or fill materials around buildings or utility lines) can result in a partially or wholly ineffective system. Low permeability areas can have high residual contaminant concentrations while vapor extraction off-gases indicate cleanup is complete.

7.4 Best Management Options to Avoid Potential Cross-Media Transfers for Vapor Extraction Technologies

General BMPs to prevent potential cross-media transfer of contaminants during cleanup activities have been addressed in Chapter 2. However, BMP options to control specific cross-media transfer of contaminants for vapor extraction technologies are addressed as follows:

Additional Site Preparation and Staging BMPs:

- ✓ Site investigation and operational plans should identify the presence of preferential subsurface air flow pathways and account for all existing underground utilities (e.g., sewers, electrical conduits).
- ✓ Design and location of extraction and injection wells are critical to ensuring proper distribution of subsurface air flow and that "dead" zones do not exist within the remediation area.
- ✓ Depth to the ground water table should be identified. Ground water monitoring wells should be installed to determine presence of LNAPL free product and its recovery strategies. The SVE system design should consider

the presence of free product, and the potential applicability of air sparging for combined vadose zone and saturated zone remediation.

- ✓ Extraction wells should not be located near surface water impoundments, underground storm sewers, or drains.

Additional Pre-Treatment Activities: During SVE system construction, including the installation of wells and/or, horizontal extraction/injection trenches, the following activities are most commonly undertaken:

- ◆ Trench excavation, well drilling, cuttings storage/treatment, drilling mud control and dewatering, air/dust control for dry-air drilling, surface protection for contaminated media.

The following BMP should be used to address these concerns:

- ✓ During dry-air drilling of contaminated soils, VOC emissions should be monitored and appropriate emission control measures should be used. For example, the drilling could be configured so that auger cutting can be directed through a large-diameter flexible pipe into bins. (See Chapter 3 for details on other emission control measures that can be applied during drilling activities.)

Vapor Extraction Treatment Activities: Prior to SVE system operation, the following activities are generally recommended for better and leak-free operation of the system:

- ✓ The number and orientation of extraction wells should be determined.
- ✓ Configuration of injection wells should be determined.
- ✓ Permeability and fracturing options should be evaluated.
- ✓ Wells should be anchored.
- ✓ Surface seals should be installed when there is potential for uncontrolled emissions.
- ✓ The system should be checked for leaks after completion of construction.
- ✓ When VOC emissions or leaks are detected from wellheads, wellhead boxes should be installed using self-sealing neoprene rubber packers to form an effective seal between the casing and upper end of the well screen for wellhead protection.
- ✓ Any emissions or discharge from the treatment process should be monitored, and control equipment such as granulated activated carbon, air stripping, and/or biofiltration to treat contaminated water and vapor should be installed, if necessary. See Table 3-3 for technologies that can be used to

control air emissions. Emission control equipment should be operated in conformance with the allowable levels specified by the regulatory authority (EPA or authorized state).

- ✓ Local dewatering should be implemented in areas of open impoundments to control water table and to enhance vadose zone air flow.
- ✓ Pumping systems should be installed, if necessary, for controlling ground water table.
- ✓ When collecting entrained liquids from vapor extraction technology systems, these liquids should generally be collected in a tank or a lined/contained system. This will prevent the contaminants within the liquids from mixing with the normal surface water runoff from the area, the surrounding natural watercourse, and surrounding soil. These contaminated aqueous streams should be treated or disposed of in accordance with the applicable regulations.
- ✓ Performance monitoring and evaluation should be conducted, including general system integrity, changes in ground water table, and rate of VOC reduction.
- ✓ Proper safety and care should be exercised to prevent any explosion during the recovery and treatment of any light non-aqueous phase liquids (LNAPLs) generated as a free product. When inlet concentrations of the SVE system exceed 10% of the lower explosion limit (LEL) of the LNAPL (NIOSH, 1990), safety measures such as remote operation of the system, temporary shutdown, or intermittent pumping as specified in USEPA, 1993 should be considered.

Post-Operation Activities: After the extraction wellhead vapor monitoring data reach asymptotic VOC concentrations, soils within the radius of influence of the drawn vacuum may not still be remediated to the cleanup goal. Thus post-treatment monitoring will be crucial to ensure the control of soil vapor generated from passive venting.

The waste streams generated by in situ SVE are vapor, treatment residuals (e.g., spent activated carbon), contaminated ground water, and soil tailings from drilling the wells. BMPs for these waste streams are as follows:

- ✓ One option for the vapor stream control/treatment unit is to use a biofiltration process for VOC removal.
- ✓ Contaminated GAC should be carefully removed from the adsorption unit and handled, stored, and disposed of or recycled in accordance with manufacturer's recommendations and appropriate state or federal regulations.
- ✓ Contaminated ground water, if extracted along with vapor, may be treated and discharged on site, if allowed, or collected and treated offsite.

- ✓ Proper decommissioning of extraction, injection, and/or monitoring wells should be conducted to prevent any future cross-media transfer of contaminants after the termination of SVE system operation in accordance with state and local regulations.

7.5 Waste Characteristics that May Increase the Likelihood of Cross-Media Contamination for Vapor Extraction Technologies

The effectiveness of vapor extraction technologies could be compromised, and undue cross-media contamination may be caused, under certain conditions identified in this subsection. However, some of these limitations could possibly be overcome by technology specific modifications, such as fracturing clay layers to increase air permeability, injecting hot air to enhance volatility. However, these modifications would likely increase the design, installation, operation and monitoring costs of the system. Please refer to technology-specific references provided at the end of this chapter for additional information about modifications or variations that can be used to enhance the effectiveness of a vapor extraction technology.

- ▶ Low permeability soils (i.e., $K < 10^{-5}$ cm/sec) (USEPA, 1995a).
- ▶ The presence of constituents that are not volatile or semi-volatile.
- ▶ Sites containing high percentage of silty clay soils and requiring very low soil clean-up levels within a short time period.
- ▶ Saturated zone soils may be problematic. Air sparging or multi-phase (dual phase) extraction may be considered to treat saturated zone soils and groundwater.
- ▶ Commingled waste may have detrimental effects on the treatment of the vapor (e.g., mercury vapor will significantly affect treatment process used on the vapor emission control).

7.6 References

1. USEPA. 1995a. Innovative Site Remediation Technology-Vacuum Vapor Extraction, Volume 8, EPA 542/B-94/002, Office of Solid Waste and Emergency Response, April.
2. USEPA. 1995b. SITE Demonstration Bulletin, Subsurface Volatilization and Ventilation System, Brown and Root Environmental, EPA/540/MR-94/529, RREL, Cincinnati, January.
3. USEPA. 1995c. SITE Demonstration Bulletin, Unterdruck-Verdempfer-Brunnen Technology (UVB) Vacuum Vaporizing Well, Roy F. Weston, Inc./IEG Technologies Corporation, EPA/540/MR-95/500, RREL, Cincinnati, January.
4. USEPA. 1995d. Review of Mathematical Modeling for Evaluating Soil Vapor Extraction Systems, EPA/540/R-95/513, Office of Research and Development, Washington, DC, July.

5. USEPA. 1995e. BMP Development Workshop Summary-Vapor Extraction, Office of Solid Waste, Permits and State Programs Division, February.
6. USEPA. 1995f. How to Evaluate Alternative Cleanup Technologies for Underground Storage Tank Sites, EPA/510/B-95/007, Office of Solid Waste and Emergency Response, May.
7. USEPA. 1994a. Soil Vapor Extraction (SVE) Treatment Technology Resource Guide. EPA/542/B-94/007, Office of Solid Waste and Emergency Response, Technology Innovation Office, Washington, DC.
8. USEPA. 1994b. Manual-Alternative Methods for Fluid Delivery and Recovery. EPA/625/R-94/003, Office of Research and Development, Washington, DC, September.
9. USEPA. 1993. Approaches for the Remediation of Federal Facility Sites Contaminated with Explosive or Radioactive Wastes, EPA/625/R-93/013, Office of Research and Development, Washington, DC, September.
10. USEPA. 1992a. Conducting Field Tests for Evaluation of Soil Vacuum Extraction Application, Office of Research and Development, Ada, OK, EPA/540/S-92/004.
11. USEPA. 1992b. A Citizen's Guide to Air Sparging. Technology Fact Sheet. EPA/542/F-92/010, Office of Solid Waste and Emergency Response, Technology Innovation Office.
12. USEPA. 1992c. Proceedings of the Symposium on Soil Venting, April 29-May 1, 1991, Houston, Texas, EPA/600/R-92/174, Office of Research and Development, Washington, DC, September.
13. USEPA. 1991a. Guide for Conducting Treatability Studies Under CERCLA: Soil Vapor Extraction, Interim Guidance (and Quick Reference Fact Sheet), EPA/540/2-91/019A and B, Office of Emergency and Remedial Response, September.
14. USEPA. 1991b. Engineering Bulletin-Air Stripping of Aqueous Solutions, EPA/540/2-91/022, Office of Research and Development, Cincinnati, OH, October.
15. USEPA. 1991c. Engineering Bulletin-In Situ Soil Vapor Extraction Treatment, EPA/540/2-91/006, Office of Emergency and Remedial Response, Washington, DC.
16. USEPA. 1991d. Reference Handbook-Soil Vapor Extraction Technology, EPA/540/2-91/003, Office of Research and Development, Washington, DC, February.
17. USEPA. 1990. State of Technology Review-Soil Vapor Extraction Systems, EPA/600/2-89/024, Hazardous Waste Engineering Research Laboratory, August.
18. National Institutes of Occupational Safety and Health (NIOSH). 1990. Pocket Guide to Chemical Hazards, US Department of Health and Human Services, June.

19. Johnson, P.C., M.W. Kemblowski, J.D. Colthart, D.L. Buyers, and C.C. Stanley. 1990. A Practical Approach to the Design, Operation, and Monitoring of In-Situ Soil Venting Systems, Shell Development/Shell Oil Company, Spring.
20. Baehr, Arthur, George Hoag, and Michael Marley. 1988. Removing Volatile Contaminants from the Unsaturated Zone by Inducing Advective Air-Phase Transport, June 20.
21. USEPA. 1989a. Soil Vapor Extraction VOC Control Technology Assessment, EPA-450/4-89/017, Office of Air Quality Planning and Standards, September.
22. USEPA. 1989b. Technology Evaluation Report: SITE Program Demonstration Test -- Terra Vac In Situ Vacuum Extraction System, Groveland, Massachusetts, Volume 1, EPA/540/5-89/003a, April.
23. USEPA. 1989c. Applications Analysis Report: Terra Vac In Situ Vacuum Extraction System, EPA/540/A5-89/003, Office of Research and Development, July.

8.0 Chapter Eight: BMPs for BIOREMEDIATION

This chapter focuses on the generally accepted best management practices (BMPs) to minimize cross-media transfer of contaminants during remedial actions or corrective measure implementations when using bioremediation technologies to treat soils or solid media. BMPs are meant only to provide guidance and general recommendations on the operational practices of selected technologies. BMPs are not meant to direct or dictate the selection of appropriate technologies.

8.1 Definition and Scope of Bioremediation (for BMPs)

Bioremediation is a treatment technology that uses biodegradation of organic contaminants through stimulation of indigenous microbial populations by providing certain amendments, such as adding oxygen or limiting nutrients, or adding exotic microbial species. It uses naturally occurring or externally-applied microorganisms to degrade and transform hazardous organic constituents into compounds of reduced toxicity and/or availability. Specific technologies fall into two broad categories: (1) Ex situ technologies (e.g., slurry phase, land treatment, solid phase, composting), and (2) In situ technologies (USEPA, 1991c). Active remediation can include addition of such amendments as nutrients or oxygen and passive remediation utilizes natural attenuation to adequately characterize, model and monitor the site to evidence natural attenuation and protection of potential receptors.

Many different types of bioremediation technologies are currently being used for soils treatment, and many more innovative approaches involving bioremediation are being developed. Considering their similarity in cross-media transfer potentials, the following treatment technologies and processes are listed as a few examples of bioremediation (for the purpose of BMPs):

- Natural Attenuation
- Biodegradation
- Aerobic/Anaerobic Biodegradation
- Biopiles
- Composting
- Land Treatment
- Bioreactors
- Bioscrubbers
- Dehalogenation
- Methanotrophic Process
- Bioremediation of Metals (Changing the Valence)
- Binding of Metals
- Plant Root Uptake (Phytoremediation)
- Fungi Inoculation Process
- Slurry Phase Bioremediation
- Solid Phase Bioremediation
- Bioventing (addressed in Chapter. 7, BMPs for Vapor Extraction)
- Bio Wall for Plume Decontamination (In Situ)

The scope of BMPs for bioremediation technologies is not limited to the above listed technologies. Any treatment technology that meet the key features of bioremediation treatment, as described below, should generally be considered as bioremediation treatments for the purpose of BMPs.

A typical schematic for solid phase bioremediation is shown on Figure 8-1.

Schematic for Solid Phase Bioremediation

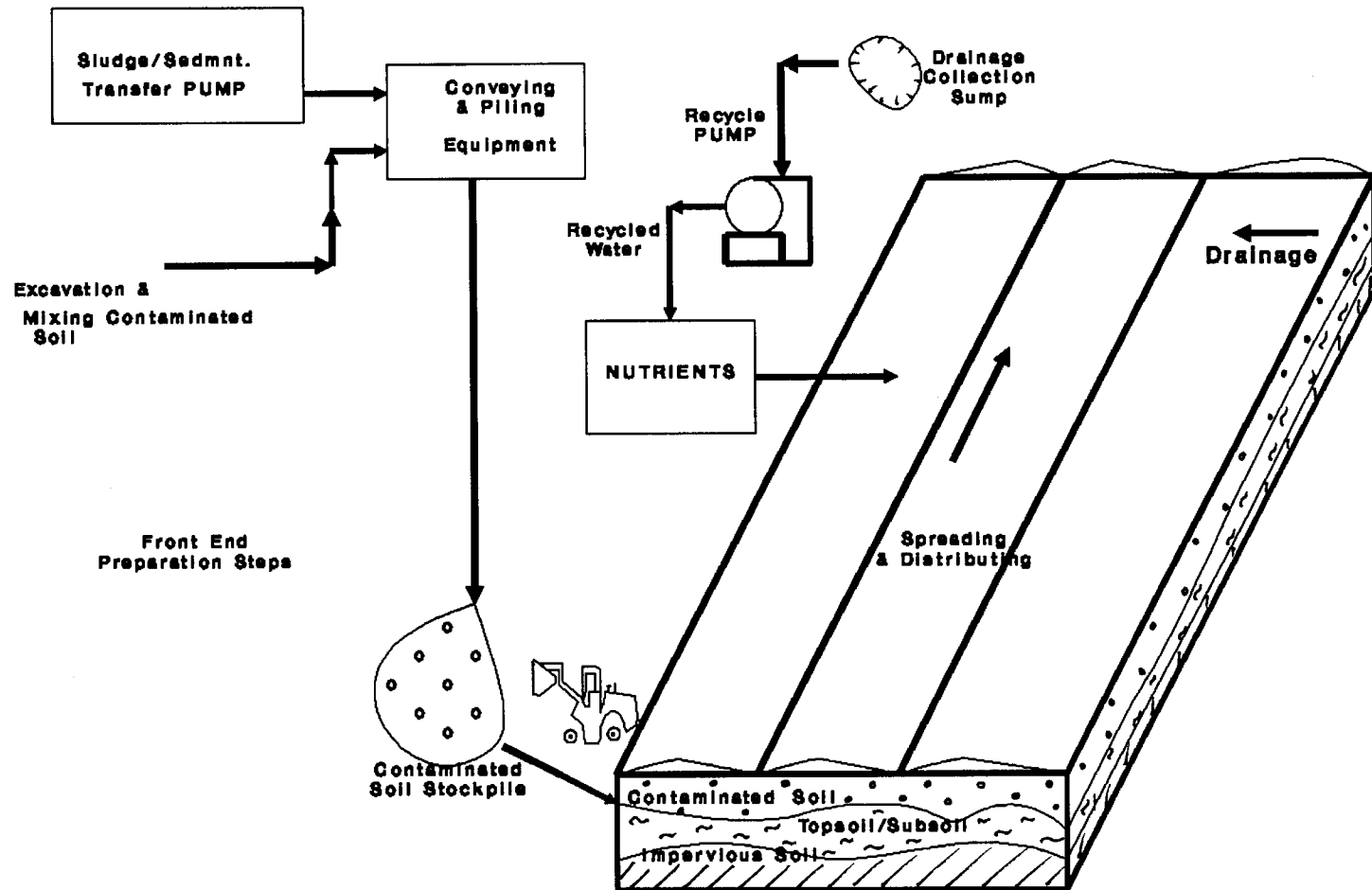

73

Source: EPA/600/R-94/203

Figure 8-1. Schematic for Solid Phase Bioremediation (USEPA, 1995c)

8.1.1 Key Features of Bioremediation for the Purpose of BMPs

- Most bioremediation soils treatment technologies generally destroy contaminants in the soil matrix.
- Generally these treatment technologies are designed to reduce toxicity either by destruction or by transforming toxic organic compounds to less toxic compounds.
- Indigenous micro-organisms, including bacteria and fungi are most commonly used. In some cases, wastes may be inoculated with specific bacteria or fungi known to biodegrade the contaminants of concern. Plants may also be used to enhance biodegradation and stabilize the soil.
- May require the addition of nutrients or electron acceptors (such as hydrogen peroxide or ozone) to enhance growth and reproduction of indigenous organisms.
- Field applications of bioremediation may involve:
 - Excavation
 - Soil handling
 - Storage of contaminated soil piles
 - Mixing of contaminated soils
 - Aeration of contaminated soils
 - Injection of fluid
 - Extraction of fluid
 - Introduction of nutrients and substrates

Several of the above field applications may not necessarily be viewed separately and may need to be used together.

8.2 Bioremediation Technology Description

Bioremediation involves the use of microorganisms to chemically degrade organic contaminants. Aerobic processes use organisms that require oxygen to be able to degrade contaminants. In some cases, additional nutrients such as nitrogen and phosphorous are also needed to encourage the growth of biodegrading organisms. A biomass of organisms -- which may include entrained constituents of the waste, partially degraded constituents, and intermediate biodegradation products -- is formed during the treatment process (USEPA, 1990d).

Although bioremediation is applied in many different ways, descriptions of typical solid-phase bioremediation, composting, bioventing, and traditional in situ biodegradation are provided here. Solid-phase bioremediation treatment can be conducted in lined land treatment units or in composting piles. A lined land treatment unit consists of a prepared bed reactor with a leachate collection system and irrigation and nutrient delivery systems. The unit also may contain air emission control equipment.

Figure 8-1 illustrates treatment by solid phase bioremediation. The soil is placed on land lined with an impervious layer, such as soil, clay, or a synthetic liner.

Solid-phase biological treatment of soil can also be performed in composting piles. Figure 8-2 illustrates a typical composting treatment process, including a compost pile, wood chip cover and base, ventilation pipes, and leachate collection system. In composting, the soil is mixed with fertilizer, water, and a bulking agent such as wood chips or sand, and placed in piles from 3 to 6 feet high (USATHAMA, 1988). The bulking agent helps to mix and aerate the material. Oxygen can be supplied to the pile by introducing air (using a blower and series of pipes) below the pile, or by turning/cultivating the pile. The addition of nutrients, such as manure or molasses, to the soil mixture can increase exothermic biodegradation reaction rates and thereby increase the operating temperature of the composting pile. The introduction of air can also help to control the temperature of the system. The addition of bulking agents will reduce the concentration of organic compounds in the soil; hence, the concentration of organics in the untreated soil must be sufficiently high to initiate and maintain the composting process.

The in situ biodegradation process is generally used in conjunction with ground water pumping and soil flushing systems to circulate nutrients and oxygen through a contaminated aquifer and associated soil (Freeman and Harris, 1995). The process usually involves introducing aerated nutrient-enriched water into the contaminated zone through a series of infiltration galleries and injection wells and recovering the water downgradient. The recovered water can then be treated, if necessary, and reintroduced to the soil on site, where allowed by applicable regulations. The in situ biodegradation system may also include aboveground treatment and conditioning of the infiltration water with nutrients and an oxygen (or other electron acceptor) source (USEPA, 1994d).

Bioventing uses relatively low-flow soil aeration techniques to enhance the biodegradation of soils contaminated with organic contaminants. Although bioventing is predominantly used to treat unsaturated soils, applications involving the remediation of saturated soils and groundwater (augmented by air sparging) are becoming more common. Generally a vacuum extraction, air injection, or combination of vacuum extraction and air injection system is employed (Freeman and Harris, 1995). An air pump, one or more air injection or vacuum extraction probes, and emissions monitors at the ground surface are commonly used.

Ex situ processes also include landfarming, which involves spreading contaminated soils over a large area. Bioremediation may also be conducted in a bioreactor, in which contaminated soil or sludge is slurried with water in a mixing tank or lagoon. Bioremediation systems require that the contaminated soil or sludge be sufficiently and homogeneously mixed to ensure optimum contact with the seed organisms (USEPA, 1990d).

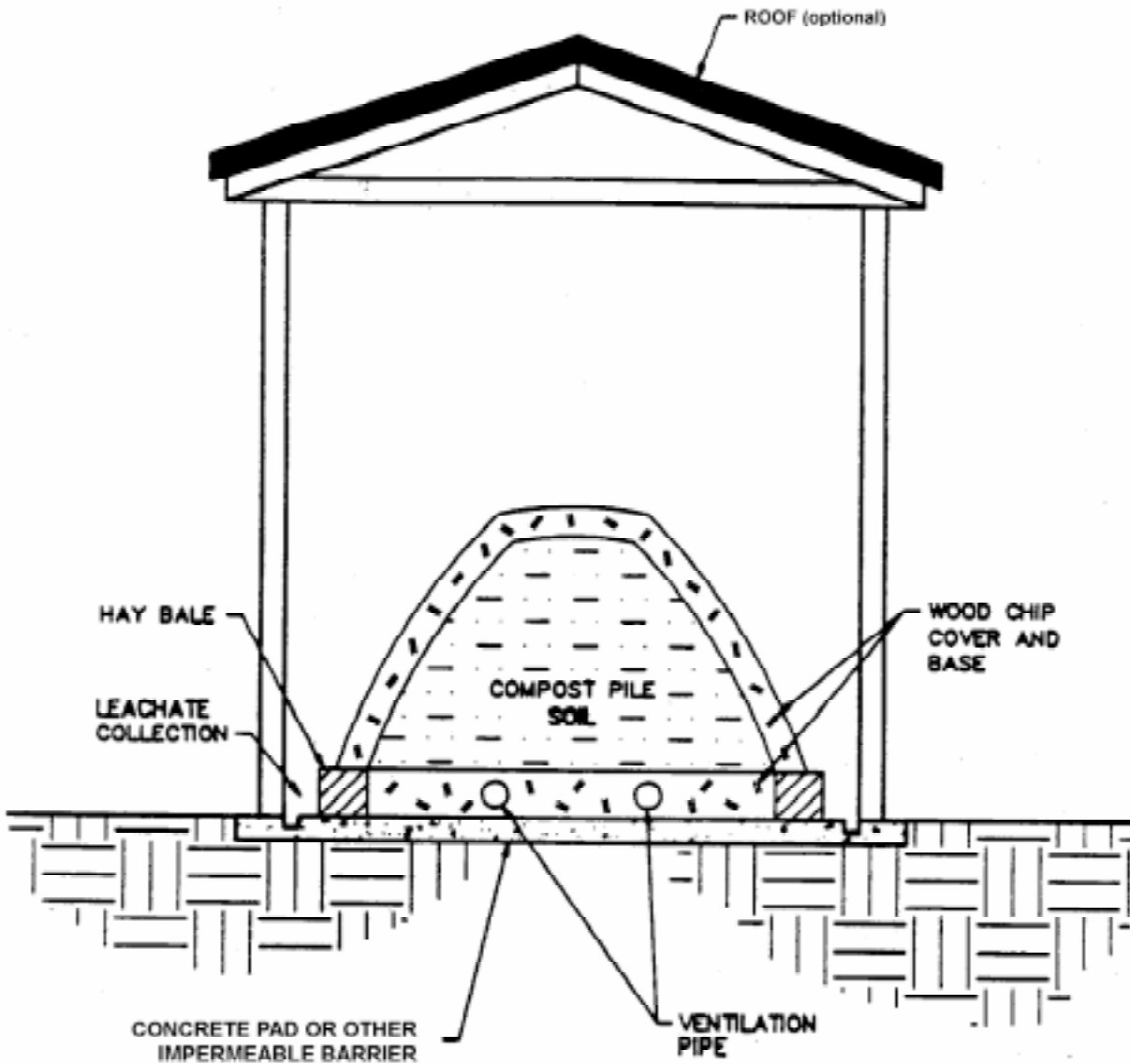

Figure 8-2. Diagram of Solid Phase Biological Treatment Using a Composting Pile (USATHAMA, 1988)

8.3 Cross-Media Transfer Potential of Bioremediation Technologies

(a) General

General cross-media transfer potentials during site preparation, pre-treatment, and post-treatment activities have been addressed in Chapter 2.

(b) Additional Concerns for Bioremediation Technologies

- Release of VOCs to air or water can occur during sampling and analysis conducted as part of the implementation of the bioremediation treatment.
- Some in situ bioremediation processes may generate soil gas emissions in excess of background levels.
- SVOC/VOC emissions may be released from leaks in pipes, joints, valves, and uncovered conveyor systems used in some bioremediation technology operations.
- Nutrients that are applied as a part of a bioremediation treatment, such as landfarming, may be carried through run off to surface water or leach to groundwater if the treatment is improperly designed and/or implemented.
- Very high wind speeds may be of particular concern due to the potential for emissions during active composting or other operations where soils may not be covered or enclosed.

8.4 Best Management Options to Avoid Potential Cross-Media Transfers for Bioremediation Technologies

General BMPs to prevent potential cross-media transfer of contaminants during pre-treatment and post-treatment activities have been addressed in Chapter 2. Only technology-specific treatment activities and possible BMP options to control cross-media transfer of contaminants during these activities are furnished below.

During the bioremediation treatment process the following activities are most commonly undertaken:

- ◆ For ex situ bioremediation, excavation, storage, mixing, and other preparatory steps are undertaken prior to feeding contaminated soil stockpile to the bioreactor or treatment bed comprised of lined land treatment units. In case of composting piles, the soil is mixed with fertilizer, water, and a bulking agent, such as wood chips or sand, and placed in piles from 3 to 6 feet high (USATHAMA, 1988). In some bioremediation application nutrients and substrates are introduced into the treatment bed. Drainage from the treatment bed is generally collected in a sump area and recycled back to the treatment bed.
- ◆ In the case of in situ bioremediation, electron acceptors (e.g., oxygen and nitrate), nutrients, and other amendments may be introduced into the soil and ground water to encourage the growth of indigenous microorganisms capable of degrading the contaminants. The principal activities surrounding in situ bioremediation involves: (a) boundary determination of the treatment zone in both horizontal extent and depth, (b) injection of nutrients and other amendments, and (c) periodic monitoring of concentration levels of contaminant in the soil or solid media. Bioventing

and other in situ biodegradation systems generally use infiltration galleries or injection wells to deliver required amendments to the subsurface.

The following BMPs may be used, when necessary and appropriate, to prevent cross-media transfer of contaminants for the above activities:

- ✓ Biotreatments occasionally produce unpleasant odors. Effective odor control measures such as vapor collection systems, or other methods as detailed in Chapter 3, should be used if necessary.
- ✓ Surface treatment structures such as biopiles or compost piles should not be constructed and maintained in areas that are prone to encounter high winds. Wind can damage plastic or tarp covers, remove surface materials such as straw or mulch that provide insulation and protection, and carry dust and nutrients away from the treatment area, thereby causing cross-media contamination. In addition, removal of surface protection increases the likelihood of infiltration of rainfall, which increases the likelihood of the production of leachate.
- ✓ For technologies such as composting, landfarming, and other surface treatments, runoff and leachate should be collected and tested regularly to ensure that nutrient levels do not exceed regulatory standards for surface water and ground water. In particular, nutrients such as phosphate and nitrate may be of concern and may need to be monitored carefully throughout the treatment process.
- ✓ Any covers or liners that are used in surface treatment structures, such as biopiles or compost piles, should be periodically examined to ensure that they have not been torn or otherwise damaged. Any damaged covers or liners should be repaired or replaced upon discovery.

8.5 Waste Characteristics that May Increase the Likelihood of Cross-Media Contamination for Bioremediation Technologies

The effectiveness of bioremediation technologies could be compromised and undue cross-media contamination may be caused under certain conditions identified in this subsection. Please refer to technology-specific references provided at the end of this chapter for additional information about modifications or variations that can be used to enhance the effectiveness of a bioremediation technology.

- ▶ All bioremediation applications are dependent upon site specific conditions and the environment or matrix in which the contamination is found. The environment and matrix situation should generally be analyzed prior to choosing the treatment method. For example, some microbes need specific properties in order to be effective (e.g., high tolerance for acid conditions, saline conditions), and some compounds need to be treated under certain conditions (e.g., aerobically, anaerobically).

- ▶ In situ bioremediation applications requiring circulation of fluids should be avoided in case of tight clay or heterogeneous subsurface environments where oxygen (or other electron acceptor) transfer limitations exist. This limitation could possibly be overcome by modification of the site or technology, but it would result in a more costly cleanup.
- ▶ Because it generally requires some time to be effective, in situ bioremediation should not be considered in the case of emergency removal/remedy - "fast cleanup". However, ex situ treatment, e.g., in a reactor, may be appropriate.
- ▶ Concentration of the contaminant above the toxicity tolerance level of the microorganisms (which varies with the bioavailability of the compound) will make biodegradation ineffective.
- ▶ Concentrations of contaminants required to sustain microbial population may be above the regulatory limit. Conversely, sometimes the microbial population cannot survive because of the concentrations of contaminants being too low to sustain it. A treatment train or other alternatives should be considered under these circumstances.
- ▶ Technologies to treat some metals in heterogeneous mixtures, such as lead and mercury, should be used very carefully (e.g., iron oxide, hexavalent chromium, mercury).

Additional BMPs for Residuals Management - Generally, there are few residuals to treat with bioremediation technologies. The exception is the bioreactor, which may generate carbon dioxide, water or other off-gases. Bioreactors should be designed with monitoring equipment to ensure that off-gases do not produce air emissions at levels higher than the state or federal regulatory limit.

- ✓ Management of treated soils, sediments, and geological material: Frequently bioremediation does not bring the concentration of individual hazardous components in soil, subsurface material, or sediment to current concentration-based standards. Depending on the bioavailability of those individual hazardous components to the human population or plants and wildlife, the hazard may or may not be controlled in the treated material. Properly remediated geological material should not release or emit hazardous constituents to soil, air or ground water in contact with the remediated material. Nevertheless, as with any technology that is used to treat hazardous wastes, engineering or institutional controls should be in place to prevent direct contact with the treated material by the human population or critical environmental receptors. If effective engineering or institutional controls are not in place to prevent exposure, a risk analysis of direct exposure should indicate that the level of risk is acceptable.

8.6 References

1. Freeman, Harry M. and Eugene F. Harris. 1995. Hazardous Waste Remediation: Innovative Treatment Technologies, Technomic Publishing Co., Inc., Lancaster, PA.
2. USEPA. 1995a. Innovative Site Remediation Technology-Bioremediation, Volume I, EPA 542/B-94/006, Office of Solid Waste and Emergency Response, June.
3. USEPA. 1995b. In Situ Remediation Technology Status Report: Treatment Walls, EPA/542/K-94/004, Office of Solid Waste and Emergency Response.
4. USEPA. 1995c. Contaminants and Remedial Options at Solvent-Contaminated Site, EPA/600/R-94/203, Office of Research and Development.
5. USEPA. 1994a. Emerging Technology Bulletin, Institute of Gas Technology, Fluid Extraction-Biological Degradation Process, EPA/540/F-94/501, March.
6. USEPA. 1994b. Engineering Bulletin-In Situ Biodegradation Treatment, EPA/540/S-94/502, Office of Research and Development, Cincinnati, OH, April.
7. USEPA. 1994c. BMP Development Workshop Summary-Bioremediation, November.
8. USEPA. 1994d. Remediation Technologies Screening Matrix and Reference Guide, EPA/542/B-94/013, October.
9. National Academy of Sciences. 1993. In Situ Bioremediation-When Does It Work? National Academy Press.
10. USEPA. 1993a. Guide for Conducting Treatability Studies Under CERCLA, Biodegradation Remedy Selection, Interim Guidance (and Quick Reference Fact Sheet), EPA/540/R-93/519a and b, Office of Solid Waste and Emergency Response, August.
11. USEPA. 1993b. Bioremediation Resource Guide, EPA/542/B-93/004, Office of Solid Waste and Emergency Response, Technology Innovation Office, Washington, DC.
12. USEPA. 1992a. Seminar Publication: Organic Air Emissions from Waste Management Facilities, EPA/625/R-92/003, Office of Air Quality Planning and Standards, August.
13. USEPA. 1992b. Engineering Bulletin-Rotating Biological Contactors, EPA/540/S-92/007, Office of Research and Development, Cincinnati, OH, October.
14. USEPA. 1992c. Engineering Bulletin-Slurry Walls. EPA/540/S-92/008, Office of Research and Development, Cincinnati, OH, October.
15. USEPA. 1992d. A Citizen's Guide to Bioventing-Technology Fact Sheet, EPA/542/F-92/008, Office of Solid Waste and Emergency Response, Technology Innovation Office.

16. USEPA. 1991a. Guide for Conducting Treatability Studies Under CERCLA: Aerobic Biodegradation Remedy Screening-Interim Guidance, EPA/540/2-91/013A, Office of Research and Development, Washington, DC.
17. USEPA. 1991b. Guide for Conducting Treatability Studies Under CERCLA: Aerobic Biodegradation Remedy Screening-Quick Reference Fact Sheet, EPA/540/2-91/013B, Office of Emergency and Remedial Response, Hazardous Site Control Division.
18. USEPA. 1991c. Innovative Treatment Technologies: Overview and Guide to Information Sources, EPA/540/9-91/002, Office of Solid Waste and Emergency Response, October.
19. Pitter, Pavel and Jan Chudoba. 1990. Biodegradability of Organic Substances in the Aquatic Environment, CRC Press.
20. USEPA. 1990a. Engineering Bulletin-Slurry Biodegradation. EPA/540/2-90/016. Office of Research and Development, Cincinnati, OH, September.
21. USEPA. 1990b. Engineering Bulletin-In Situ Biodegradation Treatment, EPA/540/S-94/502, Office of Research and Development, December.
22. USEPA. 1990c. Summary of Treatment Technology Effectiveness for Contaminated Soil, EPA/540/2-89/053, Office of Emergency and Remedial Response, Washington, DC.
23. USEPA. 1990d. Handbook on In Situ Treatment of Hazardous Waste - Contaminated Soils, EPA/540/2-90/002, Office of Research and Development.
24. Ornston, L. Nicholas, Albert Balows, and Paul Baumann. 1988. Annual Review of Microbiology, Volume 42, Annual Reviews, Inc.
25. Ross, Derek. 1988. Application of Biological Processes to the Clean Up of Hazardous Wastes. Environmental Resources Limited.
26. U.S. Army Toxic and Hazardous Materials Agency (USATHAMA) (now U.S. Army Environmental Center (USAEC)). 1988. Field Demonstration -- Composting of Explosives-Contaminated Sediment at the Louisiana Army Ammunition Plant (LAAP), September.
27. USEPA. 1986. Microbial Decomposition of Chlorinated Aromatic Compounds. EPA/600/2-86/090, Office of Research and Development, September.
28. Gibson, David T. 1984. Microbial Degradation of Organic Compounds, Marcel Dekker, Inc.
29. Chakrabarty, A.M. 1982. Biodegradation and Detoxification of Environmental Pollutants, CRC Press.

30. Pramer, David and Richard Bartha. 1972. Preparation and Processing of Soil Samples for Biodegradation Studies, *Environmental Letters*, 2(4), pp. 217-224.

9.0 Chapter Nine: BMPs for INCINERATION TREATMENT

This chapter focuses on the generally accepted best operational management practices (BMPs) to minimize cross-media transfer of contaminants during remedial actions or corrective measure implementations when using incineration technologies to treat soils or solid media. BMPs are meant only to provide guidance and general recommendations on the operational practices of selected technologies. BMPs are not meant to direct or dictate the selection of appropriate technologies.

9.1 Definition and Scope of Incineration Treatment (for BMPs)

Incineration, also known as controlled-flame combustion or calcination, is a remedial technology that destroys organic constituents in soils, debris, or other materials. An incinerator, as defined in 40 CFR 260.10, is any enclosed device that uses controlled flame and neither meets the criteria for classification as a boiler, sludge dryer, carbon regeneration unit, nor is listed as an industrial furnace; OR meets the definition of infrared incinerator (electric resistance heater) or plasma arc incinerator (electric arc). Various dictionaries and sources also define incineration as burning, scorching, or carbonization. The American Society of Mechanical Engineers (ASME) defines an incinerator as a device in which wastes are burned (rapidly oxidized) at high temperatures, usually between 1600°F to 2500°F, equivalent to 871°C to 1371°C (ASME, 1988).

The technologies included in this group are:

- Flame Oxidation
- Controlled Chamber Combustion
- Catalytic Oxidation
- Plasma Arc and Infrared Incineration
- Liquid Injection Incinerators
- Fixed/Open Hearth Incinerators
- Rotary Kiln Incinerators
- Fluidized Bed Incinerators
- Gas or Fume Incinerator

A schematic diagram of a typical incineration facility is shown on Figure 9-1. A typical liquid injection incinerator is shown on Figure 9-2. Details of a typical fixed/sloped hearth incinerator are shown on Figure 9-3. Typical multiple hearth and rotary kiln incinerators are shown in Figures 9-4 and 9-5, respectively.

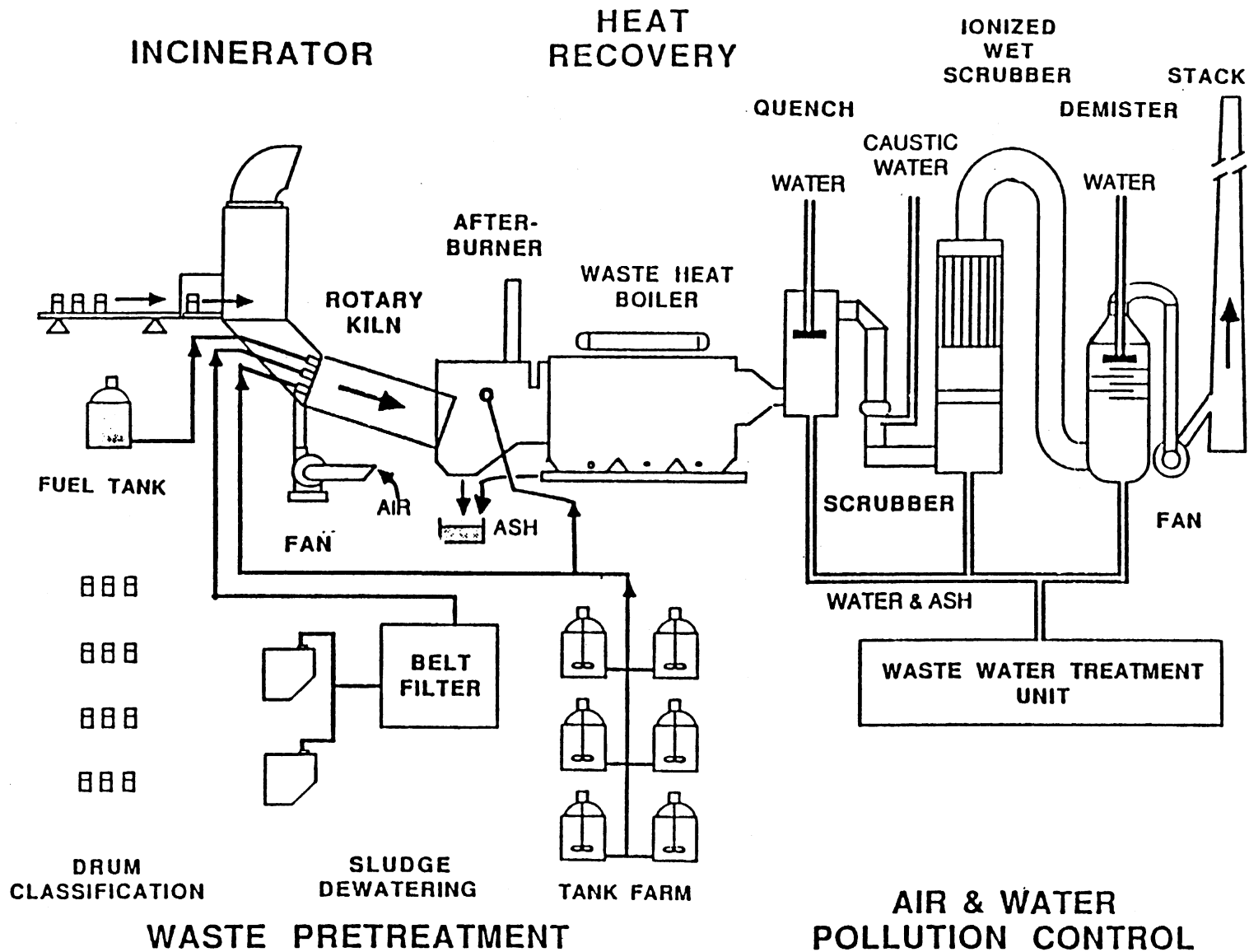

Figure 9-1. Schematic Diagram of a Typical Incineration Facility (ASME, 1988)

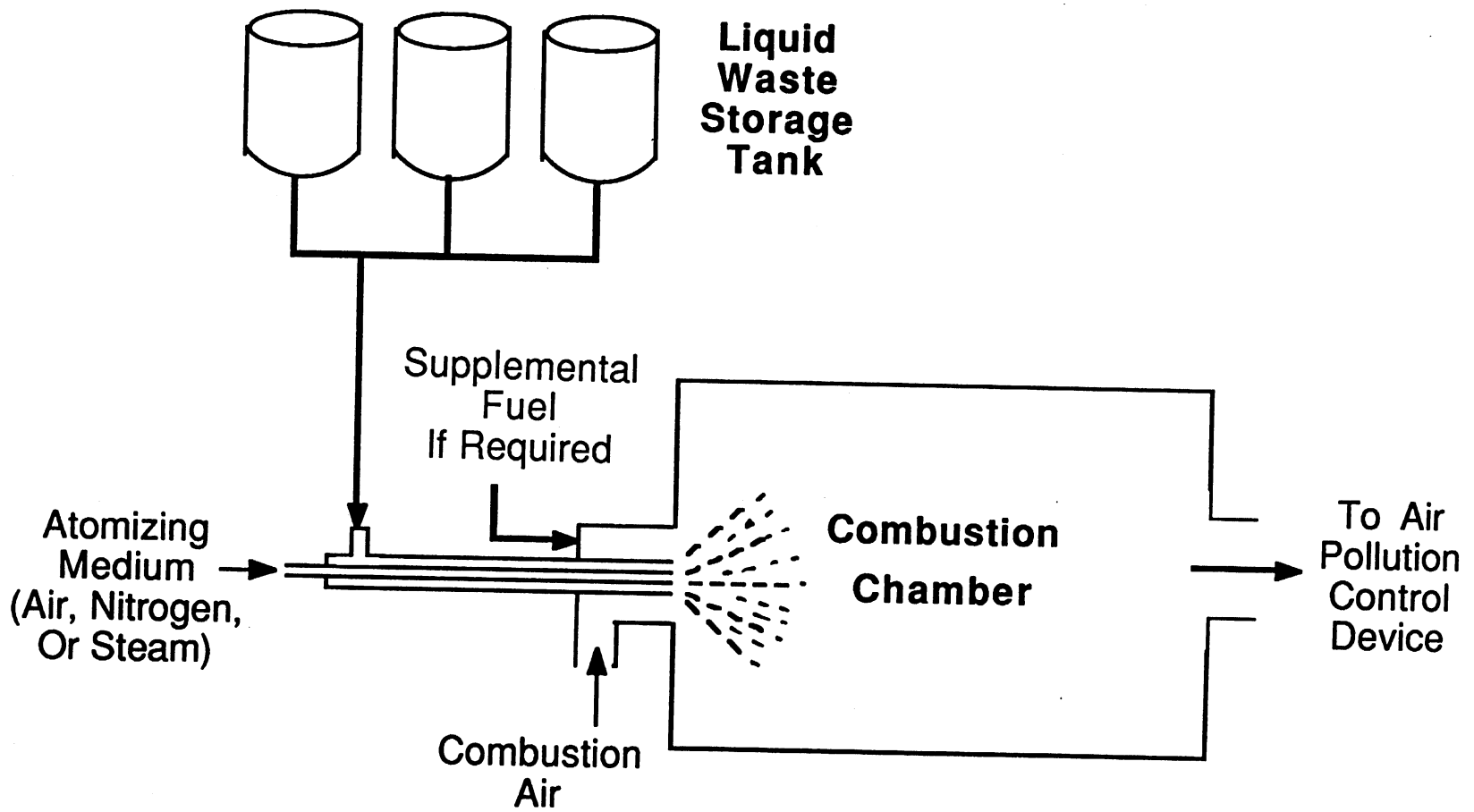

Figure 9-2. Typical Liquid Injection Incinerator (ASME, 1988)

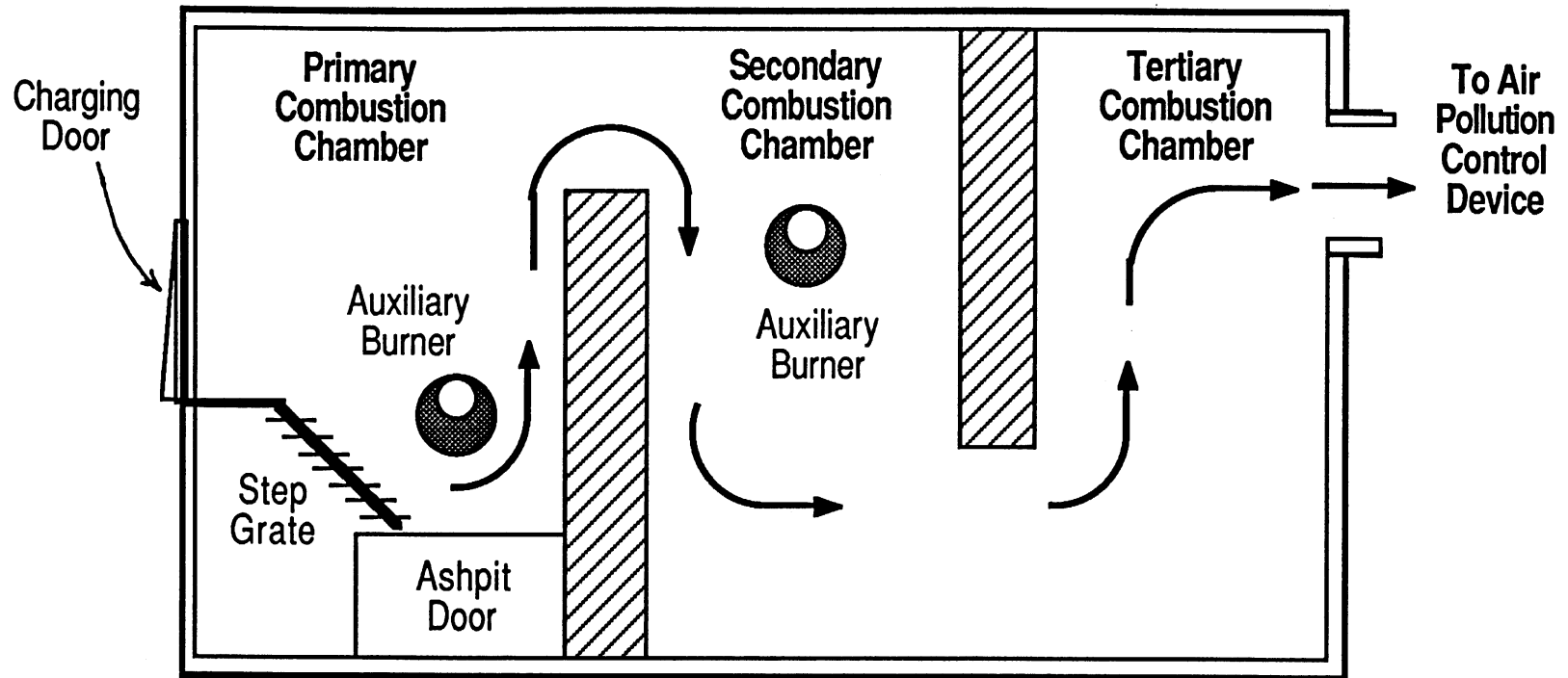

Figure 9-3. Typical Fixed/Sloped Hearth Incinerator (ASME, 1988)

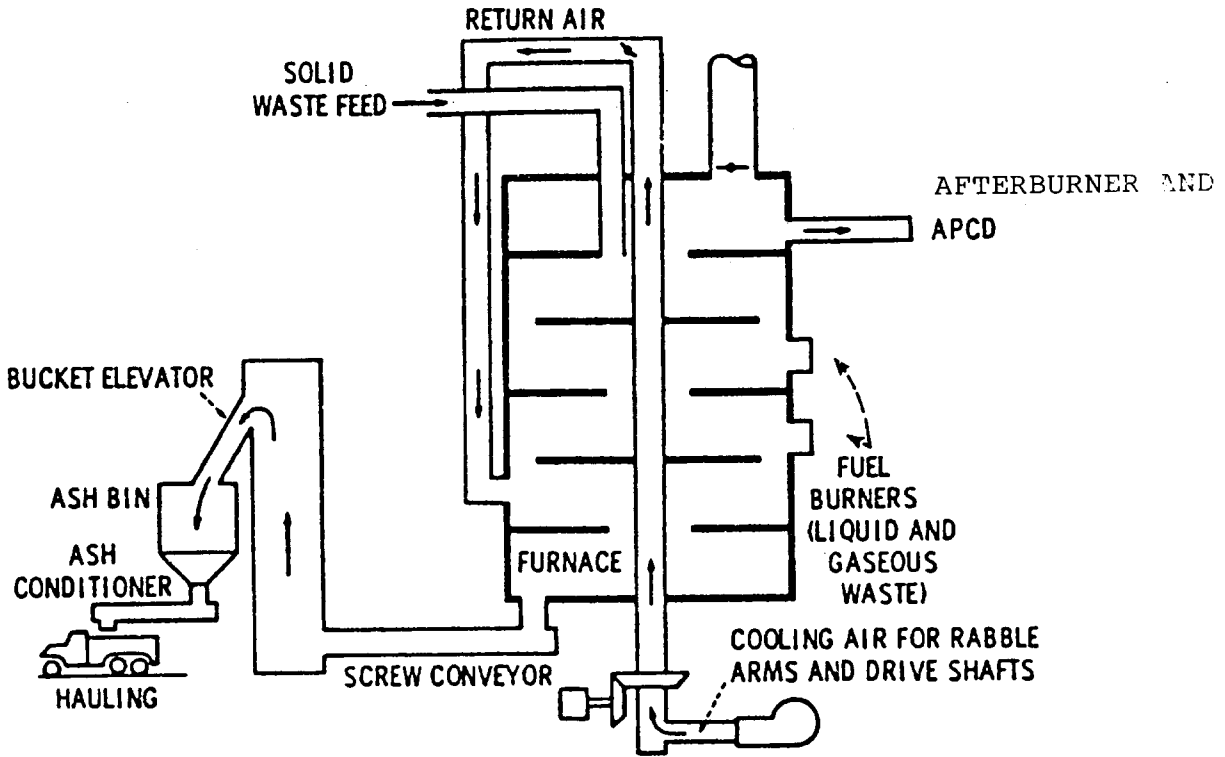

Figure 9-4. Typical Multiple Hearth Incinerator (ASME, 1988)

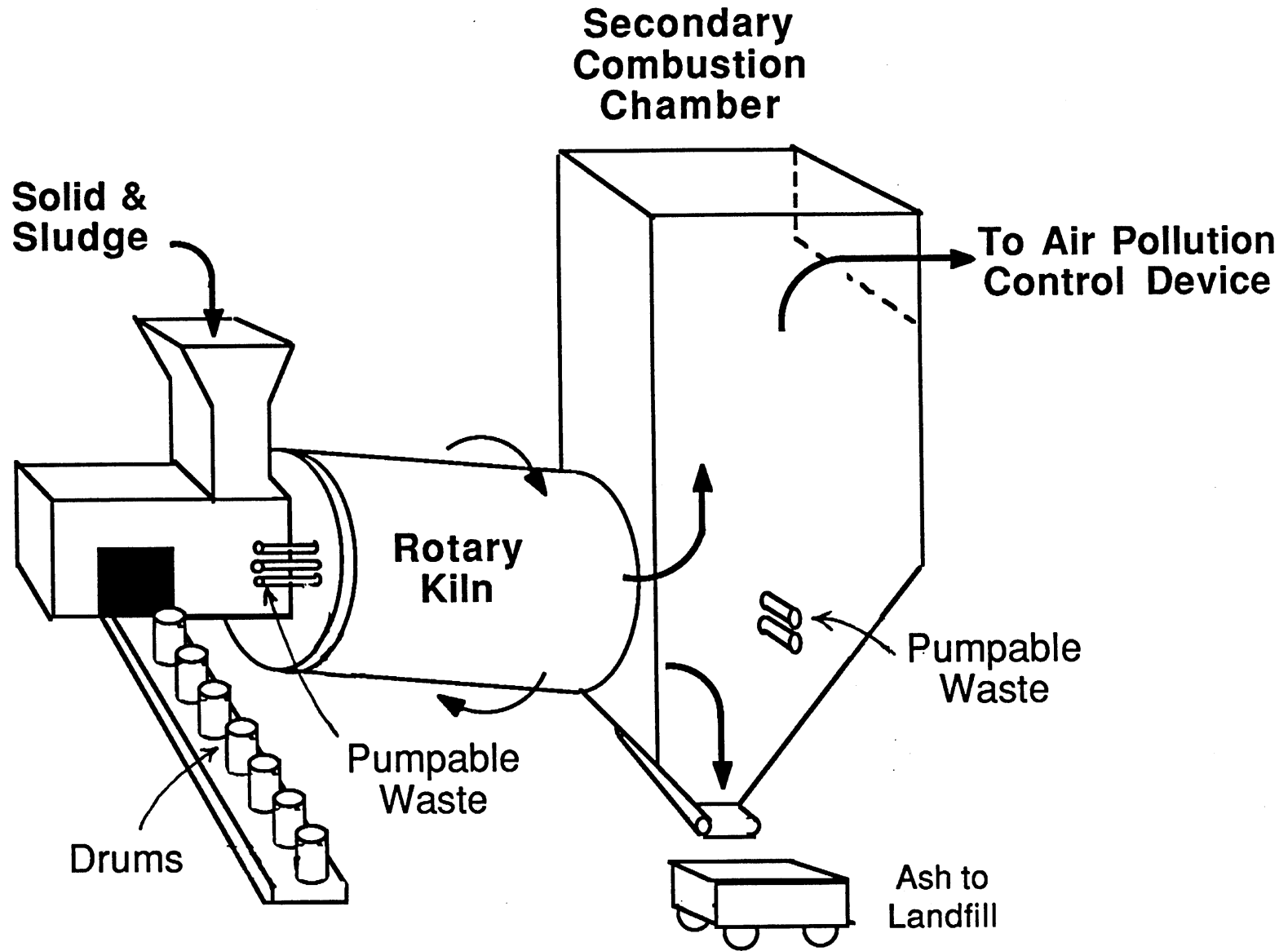

Figure 9-5. Typical Rotary Kiln Incinerator (ASME, 1988)

9.1.1 Key Features of Incineration for the Purpose of BMPs

- Used ex situ.
- Generally involves flame oxidation/burning.
- Uses closed chambers, not open burning.
- Produces stack gas emissions.
- Incineration technologies generally destroy contaminants in the soil matrix at elevated temperatures.
- Reduces volumes of toxic compounds in soils.
- Reduces toxicity of organics.
- Does not destroy most inorganic (e.g., metals) waste.
- The residence time, operating temperature, and the expanse of mixing/agitating the contaminated soil matrix or solid media (turbulence) are generally the prime operating factors in incineration.

9.2 Incineration Technology Description

The incineration process may be viewed as consisting of four steps: (1) preparation of the feed materials for placement in the incinerator, (2) incineration or combustion of the material in a combustion chamber, (3) cleaning of the resultant air stream by air pollution control devices that are suitable for the application at hand, and (4) disposal of the residues from the application of the process (including ash and air pollution control system residues) (USEPA, 1989).

Preparation/pre-processing of feed materials may include screening and mixing as well as crushing to provide a consistent particle size and homogeneity more suitable for treatment. Although extensive pre-processing will appear to increase capital and O&M costs, these costs are offset by greater levels of efficiency (and lower downtime) with which the system will subsequently operate (USEPA, 1989).

Incineration of soils generates large amounts of ash and residue. Ash characteristics will depend on the type of thermal destruction process (USEPA, 1989).

9.3 Cross-Media Transfer Potential of Incineration Technologies

(a) General

General cross-media transfer potentials during pre-treatment and post-treatment activities have been addressed in Chapter 2.

(b) **Additional Concerns for Incineration Technologies**

Types of Potential Releases:

- Fugitive emissions from fuel sources can add to the overall emissions of organics from the site.
- Incomplete combustion of organic compounds can generate "products of incomplete combustion" (PICs) which can cause serious air pollution.
- High combustion gas flow can cause problems in the gas cooling device.
- Scrubber gases are often very acidic (when the combusted soils contain high levels of chlorine or sulfur) and may cause corrosion in the system components, which in turn may cause containers to leak/fail, resulting in potential cross-media transfer of contaminants.
- Potential metal emissions with dust or due to volatilization (e.g., mercury).
- Low pH of scrubber water could cause equipment damage and leaks.
- Unless effectively managed and controlled, scrubber water/residuals from air pollution control devices also pose some threat for release of contaminants to the air, water, or soils.
- Residuals (water) generated from waste conditioning prior to incineration.
- There is potential for VOC emissions due to leaks in pipes, joints, valves, uncovered conveyor systems.
- Stack emissions from organic destruction of vapors have potential for release of contaminants in the air/natural environment above the regulatory limit.
- Inadequate control and management of baghouse dust (including ash, metals, and/or unoxidized compounds) may cause transfer of contaminants to the environment.
- When the internal temperature and/or pressure of the combustion chamber becomes too high, emergency vents are opened to allow some of the superheated gases to escape. This may allow untreated air containing volatiles, heavy metals, or other substances to be released, creating the potential for cross-media contamination.

9.4 Best Management Options to Avoid Potential Cross-Media Transfers for Incineration Technologies

General BMPs to prevent potential cross-media transfer of contaminants during pre-treatment and post-treatment activities have been addressed in Chapter 2. Only technology specific treatment activities and possible BMP options to control specific cross-media transfer of contaminants during these activities are furnished below.

During the incineration process the following activities are most commonly undertaken:

- ◆ The contaminated media is moved through a conveyor system to the incineration chamber. Heat is applied in the chamber and the waste subjected to flame oxidation/burning at a high temperature in a turbulent environment for a period of time necessary to convert the waste into carbon dioxide and water. Rotary or other type of mixing actions are generally undertaken. Waste heat is supplied to the boiler which supports the air and water pollution control units.

The following BMPs are generally recommended to be used, where appropriate, for preventing cross-media transfer of contaminants for the above activities:

- ✓ During the main treatment activities as specified above, organic or inorganic vapor emissions should be monitored and appropriate emission control measures, described in Chapter 3 of this document, should generally be used to prevent emissions above the allowable level specified by the regulatory agency (EPA or authorized state).
- ✓ The fuel storage and fuel handling areas should be added under monitoring and emission control oversight, if deemed necessary.
- ✓ Pipes, valves and fittings where fuel or pressurized liquids are involved should be checked regularly for leaks and general condition of joints.
- ✓ Three major waste streams are generated by this technology: solids from the incinerator and air emissions control system, water from the air emissions control system, and emissions from the incinerator. The following BMPs should be used to control the potential of cross-media contamination from management of these residuals:
 - Ash and treated soils or solids from the incinerator combustion chamber, as well as solids from the air emissions control system, such as fly ash or granulated activated carbon (GAC), may be contaminated with heavy metals. These residues should be tested with leachate toxicity tests. If they fail these tests, they should be treated by a process such as stabilization/solidification (see Chapter 10) and disposed of onsite or in an approved landfill (Freeman and Harris, 1995).

- Liquid waste from the air pollution emissions system may contain caustics, high levels of chlorides, volatile metals, trace organics, metal particulates, and inorganic particulates. Treatment may require neutralization, chemical precipitation, evaporation, filtration, or carbon adsorption before discharge (Freeman and Harris, 1995).

9.5 Waste Characteristics that May Increase the Likelihood of Cross-Media Contamination for Incineration Technologies

The effectiveness of incineration treatment technologies could be compromised and undue cross-media contamination may be caused under certain conditions identified in this subsection. However, some of these limitations could possibly be overcome with various technology specific modifications and variations. Please refer to technology-specific references provided at the end of this chapter for additional information about modifications or variations that can be used to enhance the effectiveness of an incineration technology.

- ▶ Since incineration does not destroy most inorganic (metals) wastes, this treatment technology may not be effective for waste media containing metals.
- ▶ May be very fuel-intensive for wastes with high moisture content.
- ▶ Wastes having low organic content may be costly to incinerate.
- ▶ Some explosive wastes may require a specially designed incinerator.
- ▶ This technology will not be applicable to wastes requiring in situ treatment.
- ▶ Wastes with high debris/large particle content may be a problem for some incinerators.

9.6 References

1. Freeman, Harry M. and Eugene F. Harris. 1995. Hazardous Waste Remediation: Innovative Treatment Technologies, Technomic Publishing Co., Inc., Lancaster, PA.
2. USEPA. 1995. BMP Development Workshop Summary-Incineration Technologies. Summary of Workshop on Incineration Technologies. March.
3. Vickery, R. 1995. Personal Communication, Memo from Dupont Facilities Services, Wilmington, Delaware, to Subijoy Dutta, October 13, 1995.
4. USEPA. 1994. Innovative Site Remediation Technology-Thermal Destruction, Volume 7, EPA/542/B-94/003, Office of Solid Waste and Emergency Response, October.

5. USEPA. 1993. Approaches for the Remediation of Federal Facility Sites Contaminated with Explosive or Radioactive Wastes, EPA/625/R-93/013, Office of Research and Development, Washington, DC, September.
6. USEPA. 1990. Engineering Bulletin-Mobile/Transportable Incineration Treatment, EPA/540/2-90/014, Office of Research and Development, Cincinnati, OH, September.
7. USEPA. 1989. Seminar Publication Corrective Action Technologies and Applications, EPA/625/4-89/020, pages 41-47.
8. ASME. 1988. Hazardous Waste Incineration, A Resource Document, American Society of Mechanical Engineers, New York, NY, January.
9. USEPA. 1988. Hazardous Waste Incineration: Questions and Answers, EPA/SW-88-018, Office of Solid Waste, Washington, DC.

10.0 Chapter Ten: BMPs for OTHER PHYSICAL/CHEMICAL TREATMENTS

This chapter focuses on the generally accepted best management practices (BMPs) to minimize cross-media transfer of contaminants during remedial actions or corrective measure implementations when using "other physical/chemical treatment technologies" to treat soils or solid media. BMPs are meant only to provide guidance and general recommendations on the operational practices of selected technologies. BMPs are not meant to direct or dictate the selection of appropriate technologies.

The category of "other physical/chemical treatment" includes all technologies that are not within the purview of the previous six chapters. BMPs for most of the in situ treatment technologies are addressed in this chapter.

10.1 Definition and Scope of Other Physical and Chemical Treatment (for BMPs)

The classification of "other physical and chemical" treatment envelops a variety of novel treatment technologies that are currently being applied to the treatment of contaminated soils and solid media. These technologies can be applied independently or in conjunction with other methods to enhance removal and/or stabilization of the contaminants.

The following technologies are listed as a few examples of "other" treatment technologies (for the purpose of BMPs):

- In Situ Radio Frequency (RF) Heating
- In Situ Vitrification
- In Situ IR Heating
- Chemical Based Stabilization
- In Situ Redox Control
- In Situ Soil Flushing
- Fracturing
- Solvent Extraction
- Phyto Uptake (Wetlands)
- Gasification/Pyrolysis
- Debris Washing
- Grouting
- Dechlorination

The scope of BMPs for other physical/chemical treatment is not limited to the above listed technologies. Although a number of treatment technologies are listed within this technology category, details of only radio frequency (RF) heating, in situ vitrification, in situ soil flushing, solidification/stabilization (S/S) and off-site disposal have been addressed in this document because of their broad applicability as it pertains to issues related to cross-media transfer of contaminants.

BMPs presented in this chapter and previous chapters of this guidance can be applied when appropriate, especially to these physical/chemical technologies that are not specifically addressed here. BMPs for in situ radio frequency heating, which is presented in this chapter, can be applied to in situ IR heating and in situ redox control. For other technologies for which BMPs are not specifically provided in this chapter, the list below provides reference to the chapter containing BMPs that can be applied to the technology.

- Phyto Uptake and Dechlorination -- Chapter 2

- Solvent Extraction and Debris Washing -- Chapter 5
- Gasification/Pyrolysis -- Chapters 6 and 9
- Fracturing -- Chapter 7

10.2 In Situ Radio Frequency (RF) Heating

10.2.1 Definition and Scope of In Situ RF Heating (for BMPs)

Radio frequency heating technologies use electromagnetic energy generated by radio waves to heat soil in situ, thereby potentially enhancing the performance of standard soil vapor extraction (SVE) technologies. RF heating is designed to accelerate the removal of volatile organics and to make it possible to remove semivolatile organics that would not normally be removed by standard SVE technologies. Contaminants are removed from in situ soils and transferred to collection or treatment facilities. The RF energy causes dielectric heating of the soil. Some conductive heating also occurs in the soil (USEPA, 1995a).

RF heating is applicable only to wastes located above the water table, unless saturated soils can be effectively dewatered.

A schematic diagram of an in situ RF heating system is shown in Figure 10-1, and a cross-sectional diagram is shown in Figure 10-2 (USEPA, 1995a).

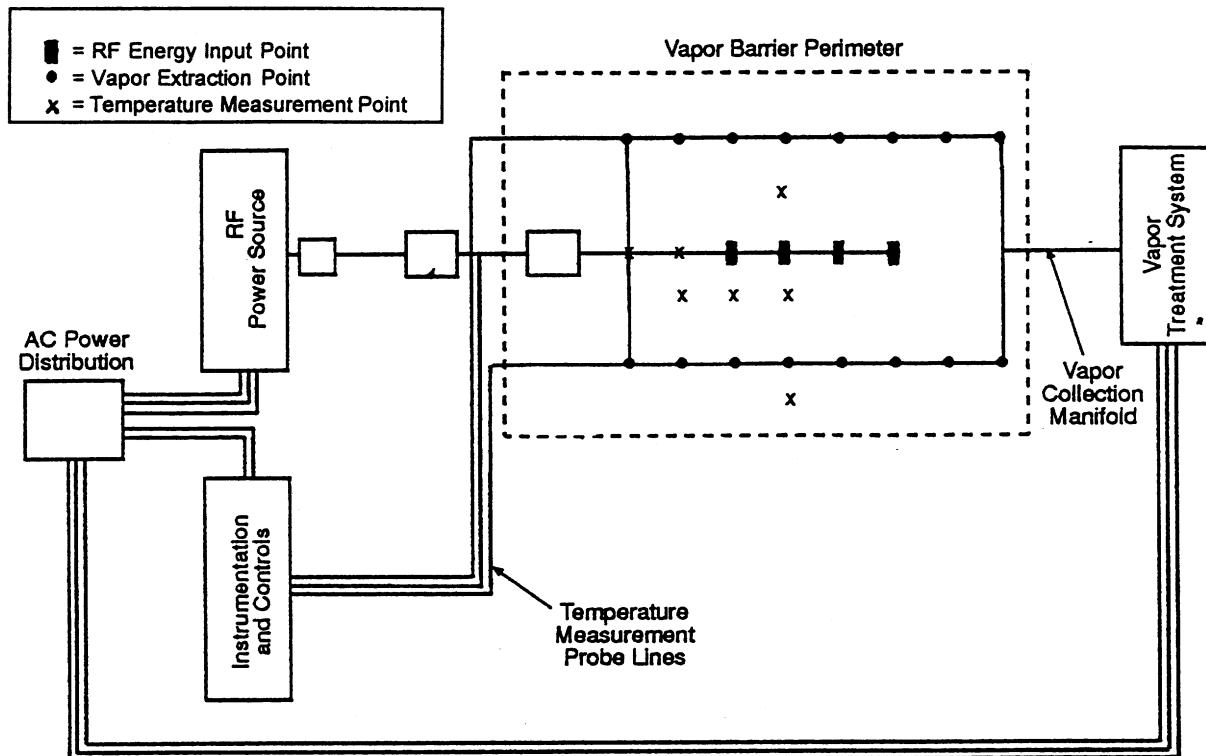

Figure 10-1. Schematic Diagram of an In Situ RF Heating System (USEPA, 1995a)

10.2.1.1 Key Features of In Situ RF Heating for the Purpose of BMPs

- Enhances the ability of SVE systems to remove organic contaminants.
- Involves inground installation of vapor extraction wells and electrodes or antennae.
- Employs a dielectric heating frequency between 2 MHz and 2,450 MHz. Operating on a frequency band allocated for industrial, scientific, and medical (ISM) equipment minimizes Federal Communications Commission (FCC) operating requirements.
- Heat soils to a temperature range of 100 to 300°C (212 to 572°F), on average for the treated area.
- Field applications involve installation of:
 - Boreholes into the contaminated area
 - A vapor extraction and treatment system
 - RF shield (sometimes) to control RF emissions
 - Electrodes or antennae

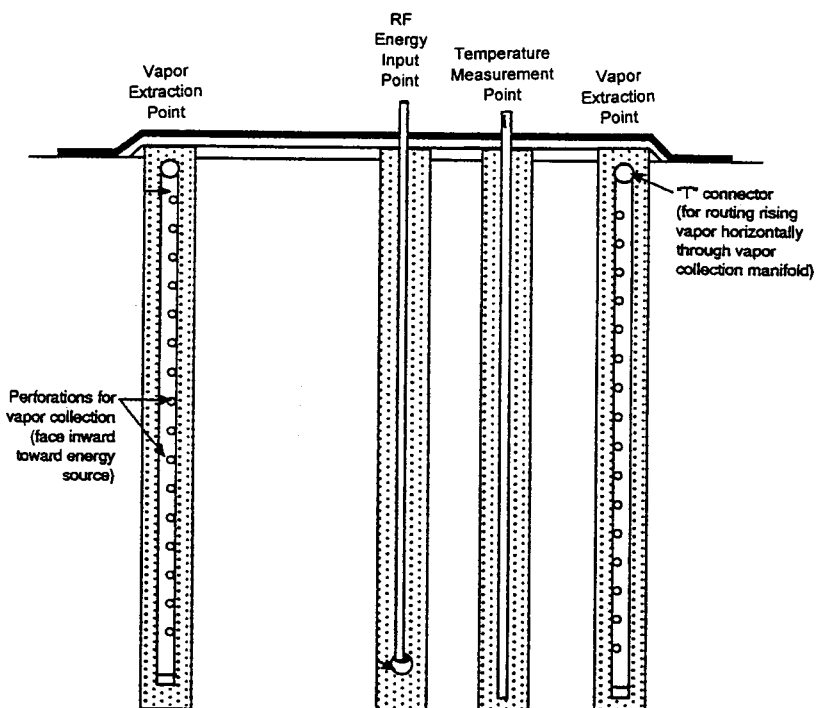

Figure 10-2. Cross-Section of an In Situ RF Heating System (USEPA, 1995a)

10.2.2 In Situ RF Heating Technology Description

RF heating is performed by applying electromagnetic energy in the radio-frequency band. The energy is delivered to electrodes placed into the soil cover. The mechanism of heat generation is similar to that of a microwave oven and does not rely on the thermal properties of the soil matrix. The power source for the process is a modified radio transmitter. The exact frequency of operations is selected after evaluation of the dielectric properties of the soil matrix and the size of the area requiring treatment. As the soil is heated due to the dissipation of the RF energy, contaminants and moisture in the soil are vaporized and pulled toward ground electrodes, which also serve as vapor extraction wells. The vaporized water may act as a steam sweep to further enhance the removal of organic contaminants. A standard SVE system provides a vacuum to the ground electrodes and transfers the vapors to collection or treatment facilities. Contaminants are treated using standard vapor treatment techniques. After soil treatment is complete, the soil is allowed to cool. The SVE system may be operated during part or all of this cooling period. The exact number of exciter and ground electrodes, electrode configurations, vapor collection or treatment techniques, and other design details are generally site-specific (USEPA, 1995a).

10.2.3 Cross-Media Transfer Potential of In Situ RF Heating

(a) General

General cross-media transfer potentials during pre-treatment and post-treatment activities have been addressed in Chapter 2. In addition, the cross-media concerns described for vapor extraction (Chapter 7) are generally applicable to this technology.

(b) Additional Concerns for In Situ RF Heating

- Release of contaminants (volatiles and particulates) during site preparation and borehole drilling.
- Migration of hot vapors to cooler zones and the resulting re-condensation of contaminants.
- Surface water intrusion from beyond the boundaries of the off-gas hood into the contaminated area that is being treated.
- Downward migration of contaminant vapors to aquifer.
- Seasonal variation of the water table which causes contaminants to move as the saturated zone fluctuates.
- The unanticipated occurrence of inorganics, such as mercury, can increase requirements for system operation, emissions control, and disposal of off-gases or other residues.
- Unexploded ordnance (UXOs) may pose a potential problem.
- With application of an SVE system, air can move through preferred channels, such as around natural gravel lenses or fill materials

around buildings or utility lines. This can result in ineffective cleanup, leaving areas untreated or treated to levels higher than allowable for closure.

10.2.4 Best Management Options to Avoid Potential Cross-Media Transfers During In Situ RF Heating

General BMPs to prevent potential cross-media transfer of contaminants during pre-treatment and post-treatment activities have been addressed in Chapter 2. Also, proper system design is recommended prior to implementation of the remedial treatment to avoid cross-media transfer problems during different treatment steps. However, BMP options to control specific cross-media transfer of contaminants for in situ RF heating treatments are furnished below.

RF Heating Treatment Activities - During the RF heating treatment process the following activities are most commonly undertaken:

- Power Source Operation. In these systems the temperature rise occurs as a result of ohmic or dielectric heating mechanisms. Ohmic heating arises as a result of ionic current or conduction current that flows in materials in response to the applied electric field. Dielectric heating arises from the physical distortion of the atomic or molecular structure of polar materials in response to the applied electric field. Since the electric field changes direction rapidly in the RF heating, the alternating physical distortion dissipates mechanical energy that is thermal energy in the material. The RF heating process raises the temperature of the soil to a range between 100 to 300°C. It employs an array of metal electrodes which are placed in boreholes drilled through the contaminated soil. The ground electrodes are generally supplied with 480-Volt, 3-phase power in major applications.
- Vapor Collection and Treatment. The hot gases and vapors are collected by means of a gas collection system and transported to the onsite vapor treatment system by means of a vacuum blower. If carbon adsorption is used to treat vapor, compressed air may be used for system control. Steam or hot air is supplied when the carbon bed is regenerated onsite. Natural gas or propane is used if flare is used to control vapors.

The following BMPs are generally recommended to be used, when necessary, for preventing cross-media transfer of contaminants for the above activities:

- ✓ Soil permeability should be tested to determine whether the vapor extraction system will be capable of efficiently collecting the volatilized contaminants, and to optimize location of vapor extraction wells.
- ✓ The site should be characterized in terms of the contaminants present, particularly any volatile metals. This assists in determining which contaminants will be volatilized by RF heating and collected by the vapor extraction system.

- ✓ Buried metallic objects such as drums and tanks should be removed to the extent possible. Also, the presence of buried explosive materials should be checked to eliminate explosion potential.
- ✓ RF excitor electrodes should not be installed close to a building or other structure.
- ✓ The configuration, number, depth, and orientation of extraction wells should be determined so that the vapor extraction system can efficiently collect any volatilized contaminants with no zones of stagnant air.
- ✓ The well diameter, length, and location of screened zones of extraction wells should be optimized so that the SVE system can efficiently collect any volatilized contaminants.
- ✓ Extraction wells should not be located near surface water impoundments, underground storm sewers, or drains.
- ✓ Well casings, screens, and other structural materials should be protected from the potential effects of RF heating, such as the development of leaks or cracks.
- ✓ Leaks and preferential pathways should be checked following completion of construction to ensure that the SVE system can efficiently collect all volatilized contaminants.
- ✓ The vapor barrier system should be designed to ensure that none of the contaminants volatilized by the RF heating are released to ambient air through the surface.
- ✓ During the main treatment activities, as specified above, Radio Frequency monitoring should be conducted to ensure that the RF field outside of the treatment zone does not exceed the National Institute of Occupational Safety and Health (NIOSH) or Federal Communications Commission (FCC) requirements.
- ✓ Organic or inorganic vapor emissions should be monitored as well and appropriate emission control measures, described in Chapter 3 of this document, should be used to prevent emissions above the allowable level specified by the regulatory agency (EPA or authorized state).
- ✓ If the vapor treatment system yields any moisture or liquids from the treatment process, the contaminated aqueous stream should be collected in a tank or a lined/contained system. This will prevent the contaminants from mixing with the normal surface water runoff from the area and the surrounding natural watercourse. The contaminated aqueous stream should be treated or disposed in accordance with the applicable regulations.

- ✓ Continued use of emissions controls may be necessary after the treatment is completed, since RF heating elevates the soil temperature and volatiles may continue to be emitted for some time following treatment.

10.2.5 Waste Characteristics that May Increase the Likelihood of Cross-Media Contamination for In Situ RF Heating

The effectiveness of in situ RF heating technologies could be compromised and undue cross-media contamination may be caused under certain conditions identified in this subsection. However, some of these limitations could possibly be overcome with various technology specific modifications and variations. Please refer to technology-specific references provided at the end of this chapter for additional information about modifications or variations that can be used to enhance the effectiveness of in situ RF heating technologies.

- ▶ Highly saturated (greater than 25% moisture) soils will consume enormous amounts of energy as the application of the RF heat causes the water to evaporate, reducing the efficiency of the RF system.
- ▶ RF heating will not treat nonvolatile organics, inorganics, metals, and heavy oil.
- ▶ Certain RF heating technologies may not operate most effectively at depths below 50 feet (USEPA, 1995a).
- ▶ Contaminants in clayey soils are usually strongly sorbed and difficult to remove (USEPA, 1995b), which reduces the efficiency of the RF system.

10.3 In Situ Vitrification

10.3.1 Definition and Scope of In Situ Vitrification (ISV) (for BMPs)

In situ vitrification (ISV) uses electrical power to heat and melt earthen materials (e.g., soils, sludges, mine tailings, sediments), waste materials buried in earthen materials, and other earthen-like materials contaminated with organic, inorganic, and metal-bearing hazardous and/or radioactive wastes. The molten material cools to form a hard, monolithic, chemically inert, amorphous or crystalline product that incorporates and immobilizes the thermally stable inorganic compounds and heavy metals in the hazardous waste. Organic contaminants are either volatilized and captured at the hood or pyrolyzed to form more volatile constituents, which are subsequently volatilized and captured at the hood. The slag product is glass-like with very low leaching characteristics.

A flowchart of the ISV process is shown in Figure 10-3. A cut-away view of a treatment cell specifying the general limits for the volume treated is shown in Figure 10-4 (USEPA, 1994a).

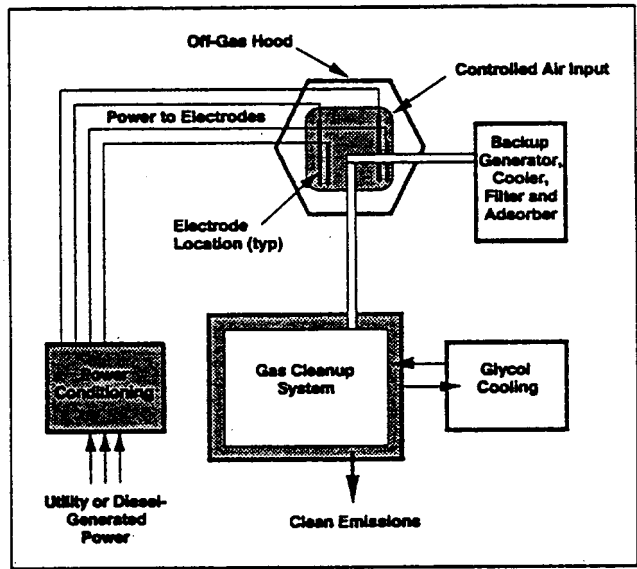

Figure 10-3. ISV Equipment System (USEPA, 1994a)

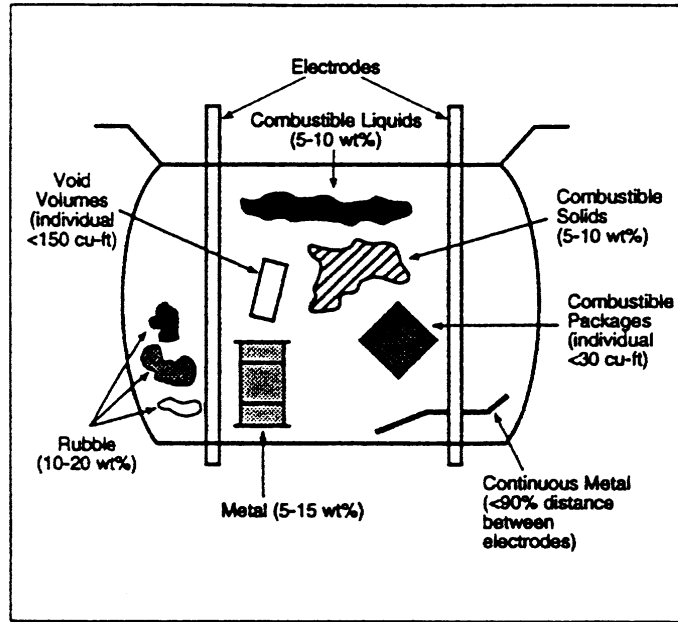

Figure 10-4. A Cut-Away View of a Typical Treatment Cell (USEPA, 1994a)

10.3.1.1 Key Features of In Situ Vitrification for the Purpose of BMPs

- Converts non-volatile inorganic waste into a non-leachable vitrified mass.
- Gases/vapors are passed through the off-gas treatment system and released to the environment.
- Uses electrical energy to heat and melt soil.
- Heats soils to a temperature range of 1600 to 2000°C (2900 to 3600°F).
- Field applications involve installation of:
 - 12-inch outside diameter (OD) graphite electrodes
 - Off-gas quenching system that includes a water-based quenching tower and high efficiency Venturi scrubber; a secondary cooling system (glycol-based) is then employed to keep the water temperature within limits
 - Optional aboveground thermal oxidizer for treating organic vapors
 - Electrical supply line and transformer

10.3.2 In Situ Vitrification Technology Description

Several methods and configurations exist for the application of ISV. At a site that has only a relatively shallow layer of contamination, the contaminated layer may be excavated and transported to a pit where the vitrification will take place. At other sites where the contamination is much deeper, thermal barriers could be placed along the site to be vitrified and prevent the movement of heat and glass into adjacent areas. This will force the heat energy downward and melt depths will be increased. A more conventional approach to using ISV is to encapsulate the wastes and control the potential for lateral migration of contaminants within a checkerboard pattern of melts.

ISV uses a square array of electrodes up to 18 feet apart, which is inserted to a depth of 1 to 5 feet and potentially can treat down to a depth of 20 feet to remediate a contaminated area. As the vitrified zone grows, it vitrifies metals and either vaporizes or pyrolyses organic contaminants. A hood placed over the processing area is used to collect combustion gases, which are treated in an off-gas treatment system. The gases collected by the hood are treated by quenching, scrubbing, mist-elimination, heating, particulate filtration, and activated carbon adsorption (USEPA, 1994a).

10.3.3 Cross-Media Transfer Potential of In Situ Vitrification

(a) General

General cross-media transfer potentials during pre-treatment and post-treatment activities have been addressed in Chapter 2.

(b) Additional Concerns for In Situ Vitrification

- Release of contaminants (volatiles and particulates) during site preparation.
- Possible hazards due to high voltage electrical fluxes.
- Downward migration of melted contaminants or contaminant vapors to aquifer.
- Contaminant vapors can be released away from the treatment zone if there is an open pathway (e.g., pipe, french drain) that intercepts the treatment zone. Sites should be inspected for open subsurface conduits prior to applying ISV.

10.3.4 Best Management Options to Avoid Potential Cross-Media Transfers During ISV

During ISV treatment activities, measures may need to be taken to control fugitive emissions and to prevent release of contaminated media to the natural environment. The following BMPs are generally recommended to be used when necessary for preventing cross-media transfer of contaminants for the above activities:

- ✓ During large-scale operations, pumping wells and/or intercept trenches should be installed around the treatment zone. This will prevent groundwater from flowing through a contaminated treatment zone.
- ✓ If open subsurface conduits are found, they should be disrupted (e.g., collapsed, broken, filled) prior to treatment.
- ✓ The ISV treatment activities should be conducted under a controlled environment when the off gases, volatiles, dusts, etc. are being emitted at levels above the regulatory limit. The VOC emissions associated with these activities should be controlled by capturing these emissions and then treating the captured vapor/air.
- ✓ To minimize disruption of contaminated soil, a thin layer of clean cover soil should be placed over the contaminated area prior to the placement of the off-gas collection hood. This practice eliminates the possibilities of airborne contamination and tracking of contaminated material across the site.
- ✓ If the vapor treatment system yields any moisture or liquids from the treatment process, the contaminated aqueous streams should be collected in a tank or a lined/contained system. This will prevent the contaminants from mixing with the normal surface water runoff from the area and the surrounding natural watercourse. The contaminated aqueous stream should be treated or disposed in accordance with the applicable regulations.
- ✓ Typically 20-40% volume reductions occur as a result of the melting process, which can lead to subsidence within the treated zone. Clean soil is generally placed to fill in the subsided region as a standard practice, and this should be consistently followed in all ISV treatment.
- ✓ Arrangements should be made for leaving the vitrified mass in place or exhuming it and disposing of it properly.
- ✓ If the vitrified soil is to be left in place, clean soil should be backfilled over it to encourage regrowth of vegetation.
- ✓ Electrodes may be removed, decontaminated, reused, disposed of, or left in the vitrified mass.
- ✓ Drums or tanks filled with liquid, if removed from the treatment area, should be disposed of in compliance with the applicable state and/or federal regulations.

10.3.5 Waste Characteristics that May Increase the Likelihood of Cross-Media Contamination for In Situ Vitrification Technologies

The effectiveness of in situ vitrification technologies could be compromised and undue cross-media contamination may be caused under certain conditions identified in

this subsection. However, some of these limitations could possibly be overcome with various technology specific modifications and variations. Please refer to technology-specific references provided at the end of this chapter for additional information about modifications or variations that can be used to enhance the effectiveness of in situ vitrification technologies.

- ▶ Organic contents of greater than 10% by weight within the soil matrix might require additional or modified off-gas treatment components. Alternatively, soils of higher organic contents (e.g., exceeding 20%) have been successfully treated by slowing the melting rate to levels that allow acceptable heat removal rates in the off-gas treatment system (Campbell, 1995).
- ▶ Pockets of flammable liquid or vapor sealed in containers beneath the soil surface can create a potential explosion hazard.
- ▶ In cases where heavy metal immobilization is desired, soils containing less than 50% by weight of glass formers (e.g., aluminum and silica), and < 2% by weight of alkali compounds (e.g., sodium and potassium), may require modification with additives to obtain desired melt and vitrified product characteristics (Campbell, 1995).
- ▶ Depths greater than 20 feet (6 meters) require higher power-level equipment because of the larger masses and volume that are being treated (Campbell, 1995).
- ▶ Soils that contain inorganic debris greater than 55% by volume are extremely difficult to treat with this technology (Campbell, 1995).
- ▶ Soils with high ground water recharge rates require special methods to limit recharge to acceptable rates.

10.4 In Situ Soil Flushing

10.4.1 Definition and Scope of In Situ Soil Flushing (for BMPs)

In situ soil flushing is the extraction of contaminants from the soil with water or other suitable aqueous solutions. Soil flushing is accomplished by passing the extraction fluid through in-place soils using an injection or infiltration process. Extraction fluids must be recovered and, when possible, are recycled. Typically, soil flushing is used in conjunction with other treatments that destroy contaminants or remove them from the extraction fluid and groundwater (USEPA, 1992a).

In situ soil flushing includes conventional and unconventional techniques. The conventional techniques include well-and-capture methods in the vadose zone and pump-and-treat systems in the saturated zone. Unconventional techniques consist of primary, secondary, and tertiary recovery techniques (USEPA, 1993a).

Figure 10-5 is a schematic diagram of an in situ soil flushing system in which the treatment solvent is injected into the soil (USEPA, 1993a). Figure 10-6 is a schematic diagram of an in situ soil flushing sprinkler system (USEPA, 1993a). Figure 10-7 is a cross-section of an in situ soil flushing system that uses spray application (USEPA, 1991b).

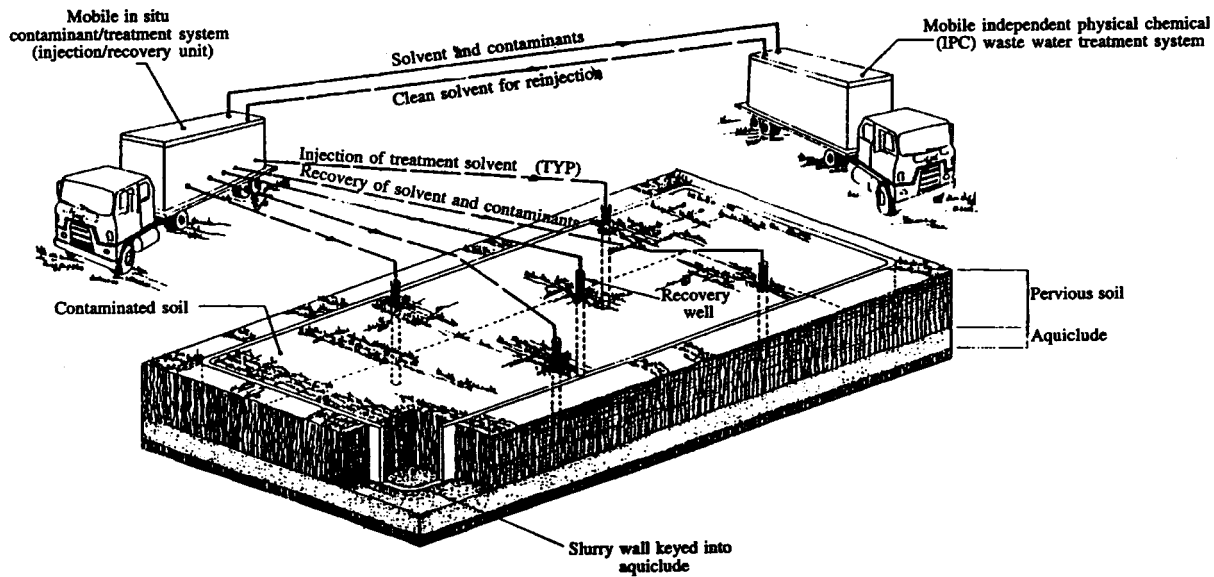

Figure 10-5. Schematic of In Situ Flushing Field Test System (USEPA, 1993a)

10.4.1.1 Key Features of In Situ Soil Flushing for the Purpose of BMPs

- Fluid injection.
- Contaminant mobilization and removal.
- Secondary and tertiary recovery in some cases.
- Field applications involve installation of:
 - Subsurface injection wells or aboveground sprinkler/infiltration bed systems
 - Boreholes for recovery wells or other subsurface recovery devices in the contaminated area
 - Delivery and recovery drain lines
 - Reagent delivery system
 - Produced fluid treatment system
 - Physical (e.g., sheet pile wall) or hydraulic (e.g., groundwater depression or mounding) barriers to contain contaminants

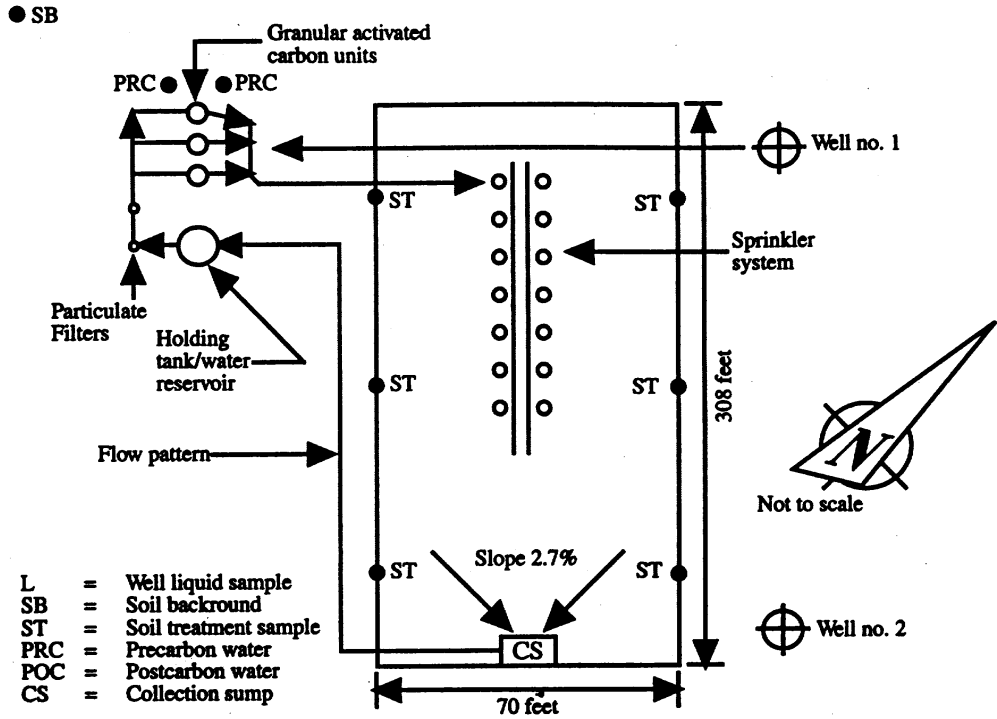

Figure 10-6. Soil Flushing Sprinkler System (USEPA, 1993a)

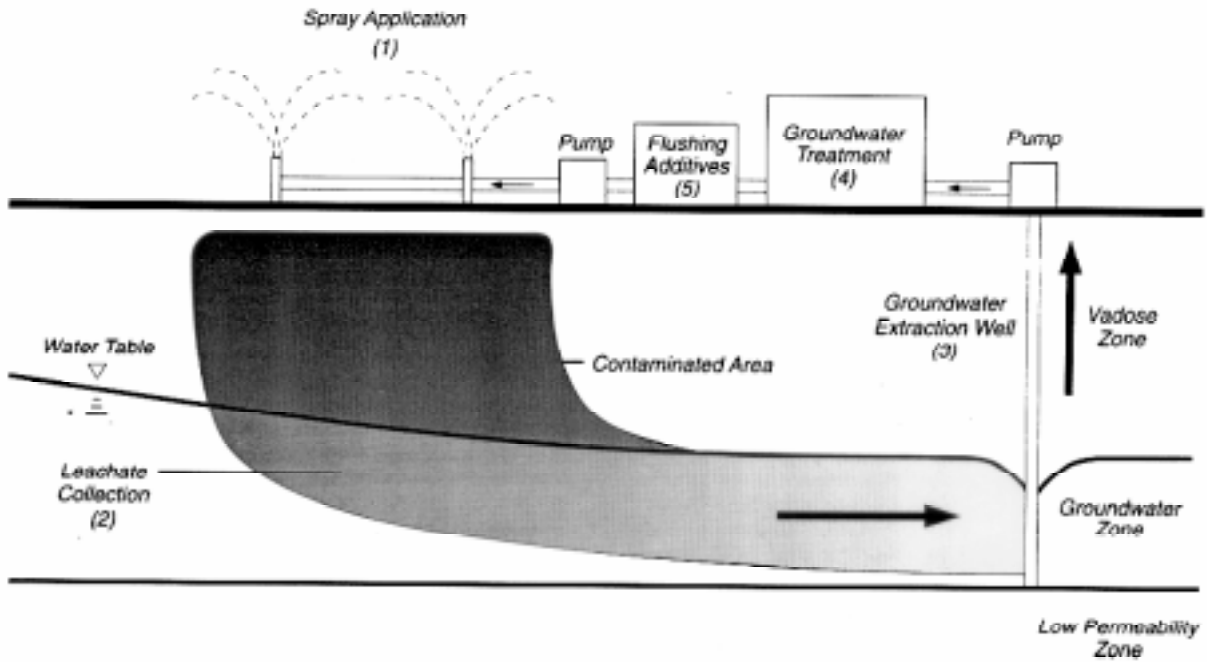

Figure 10-7. Schematic of Soil Flushing System (USEPA, 1991b)

10.4.2 In Situ Soil Flushing Technology Description

Schematics of different types of in situ soil flushing applications are provided in Figures 10-5 through 10-7.

In situ soil flushing includes conventional and unconventional techniques. The conventional techniques include well-and-capture methods in the vadose zone and pump-and-treat systems in the saturated zone. Unconventional techniques consist of primary, secondary, and tertiary recovery techniques (USEPA, 1993a).

10.4.3 Cross-Media Transfer Potential of In Situ Soil Flushing

(a) General

General cross-media transfer potentials during pre-treatment and post-treatment activities have been addressed in Chapter 2. Soil flushing is different from most other technologies used to remediate contaminated soils; therefore, the concerns about cross-media contamination are fairly unique and are discussed in the next section.

(b) Additional Concerns for In Situ Soil Flushing

- The primary waste stream generated is contaminated flushing fluid, which is recovered along with groundwater (Freeman and Harris, 1995). This fluid can cause cross-media contamination by migrating into uncontaminated groundwater zones, or if mismanaged, can be released into the surface environment.
- Treatment of the flushing fluid results in process sludges and residual solids, such as spent carbon and spent ion exchange resin, which may cause cross-media transfer of contaminants if improperly managed and disposed (Freeman and Harris, 1995).
- Residual flushing additives in the soil may be a concern and should be evaluated on a site-specific basis. These additives may require additional separation or treatment prior to disposal (Freeman and Harris, 1995).
- Bacterial fouling of infiltration and recovery systems and treatment units may be a problem, particularly if high iron concentrations are present in the groundwater or if biodegradable reagents are used.

10.4.4 Best Management Options to Avoid Potential Cross-Media Transfers During In Situ Soil Flushing

General BMPs to prevent potential cross-media transfer of contaminants during pre-treatment and post-treatment activities have been addressed in Chapter 2. BMP options to control specific cross-media transfer of contaminants for in situ flushing are furnished below:

- ✓ A thorough site characterization should be conducted to determine all leachable contaminants present.
- ✓ Depth to groundwater (including any seasonal variations) and presence of free product, if any, should be identified. All free product should generally be recovered before any treatment begins.
- ✓ During construction of injection wells, care should be taken to properly:
 - Anchor wells
 - Install suitable screen meshes
 - Protect the wellhead
- ✓ The recovery system should have adequate capacity to collect injected fluids and groundwater, taking into account maximum practical aquifer yield.
- ✓ If bacterial fouling of any part of the treatment system is a problem, the addition of compounds to control bacterial growth should be considered.

10.4.5 Waste Characteristics that May Increase the Likelihood of Cross-Media Contamination for In Situ Flushing Technologies

Under the following conditions the effectiveness of in situ soil flushing (as categorized for BMPs) could be compromised, and could cause undue cross-media contamination.

- ▶ Soils containing a high percentage of silt- and clay-sized particles typically are strongly adsorbed and are difficult to remove. These soils also tend to be less permeable (Freeman and Harris, 1995). The application of in situ soil flushing to soils with these characteristics may increase the need to use additives and reduce the efficiency of contaminant removal. Reduced contaminant removal may require the treatment of very large volumes of groundwater, which may increase the potential for cross-media contamination.
- ▶ Soils with low hydraulic conductivity (e.g., $K < 1.0 \times 10^{-5}$ cm/sec) will limit the ability of flushing fluids to percolate through the soil in a reasonable time frame (Freeman and Harris, 1995).
- ▶ Moisture content can affect the amount of flushing fluids required. Dry soils will require more flushing fluids initially to mobilize contaminants (Freeman and Harris, 1995).
- ▶ High humic content and high cation exchange capacity tend to reduce the removal efficiency of soil flushing (Freeman and Harris, 1995).
- ▶ Multiple factors, including high concentrations of fine sedimentary materials, inorganic precipitation, formation of stable emulsions, or

excessive biological activity can reduce the permeability required for successful treatment (USEPA, 1993a).

10.5 Solidification/Stabilization

10.5.1 Definition and Scope of Solidification/Stabilization (for BMPs)

Solidification and stabilization (S/S) waste treatment processes involve the mixing of specialized additives or reagents with waste materials to reduce physically or chemically the solubility or mobility of contaminants in the environmental matrix (Freeman and Harris, 1995). Solidification and stabilization are closely related due to the fact that both use chemical, physical, and thermal processes to detoxify a hazardous waste. But they are distinct technologies that involve physical/chemical treatment process.

Figure 10-8 shows a schematic of typical S/S processes.

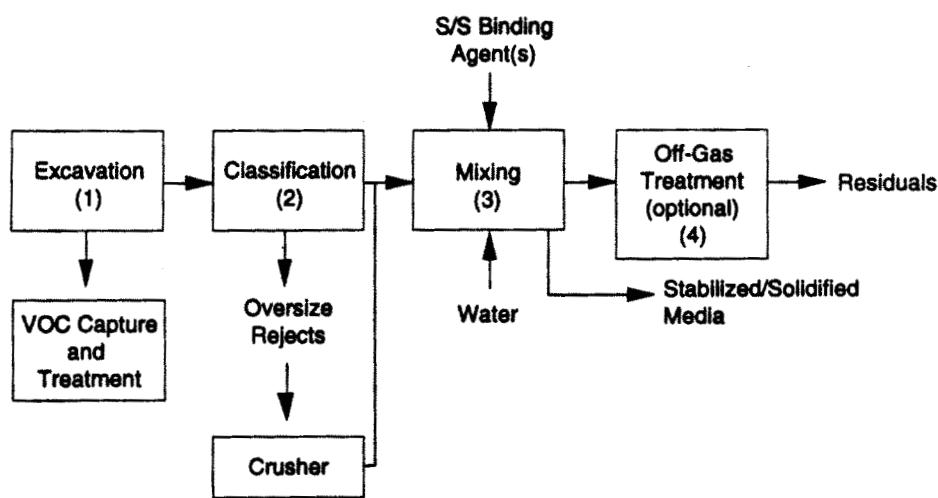

Ex Situ S/S Process

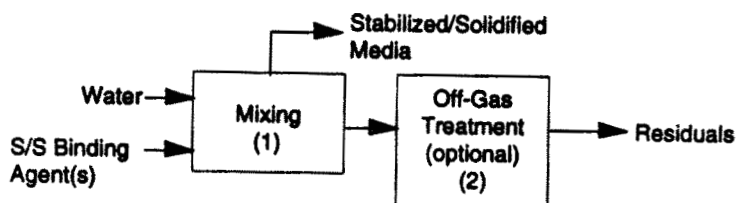

In Situ S/S Process

Figure 10-8. Generic Elements of Typical S/S Processes (USEPA, 1993d)

10.5.1.1 Key Features of Solidification/Stabilization for the Purpose of BMPs

- Requires mixing of reagents, either on- or off-site.
- Immobilizes contaminants.
- Like other immobilization technologies, does not destroy inorganic waste, but may alter or change organic waste.
- Stabilization can be combined with encapsulation or other immobilization technology(ies).
- May increase total volume of materials that must be handled as waste.
- Wastes treated with S/S may be amenable to reuse following treatment.
- Field application may involve installation of any or all of the following:
 - Auger type drilling and mixing equipment for in situ applications
 - Dust collection systems
 - Volatile emission control systems
 - Bulk storage tanks

10.5.2 Solidification and Stabilization Technology Description

Solidification refers to processes that encapsulate the waste in a monolithic solid with structural integrity. The encapsulation may be that of compacted fine waste particles or of a large block or container of wastes. Solidification does not necessarily involve a chemical interaction between the waste and the solidifying reagents, but may mechanically bind the waste in the monolith. Contaminant migration is restricted by vastly decreasing the surface area exposed to leaching and/or by isolating the waste within an impervious capsule (USEPA, 1994c).

Stabilization refers to processes that reduce risk posed by a waste by converting the contaminants into a less soluble, mobile, or toxic form. The physical nature of the waste is not necessarily changed. Phosphates, sulfides, carbonates, etc. can be used as treatment reagent.

In many instances stabilization is exclusive of solidification. Stabilized product should have low leaching characteristics. Many of the reagents used for S/S process are also used in other chemical treatment processes such as dechlorination.

S/S systems can be used to treat contaminated soil or wastes in place or can be employed to treat excavated wastes externally for their subsequent disposal.

10.5.3 Cross-Media Transfer Potential of Solidification/Stabilization

(a) General

General cross-media transfer potentials during pre-treatment and post-treatment activities have been addressed in Chapter 2.

(b) Additional Concerns for Solidification/Stabilization

- Leaching of contaminants or excess reagents to ground water from treated waste that is disposed on site.
- Long-term degradation of the stabilized mass, creating the potential for solidified wastes, reagents, VOCs, and other contaminants to be released from the treated waste.

10.5.4 Best Management Options to Avoid Potential Cross-Media Transfers During Solidification/Stabilization

General BMPs to prevent potential cross-media transfer of contaminants during typical S/S pre-treatment and post-treatment activities have been addressed in Chapter 2. BMP options to control specific cross-media transfer of contaminants for S/S pre-treatment and treatment technologies are furnished below:

- ✓ Under dry and/or windy environmental conditions, both ex situ and in situ S/S processes are likely to generate fugitive dusts (Freeman and Harris, 1995). Refer to Chapter 2 for control mechanisms to reduce the potential for cross-media contamination from fugitive dusts.
- ✓ Materials that are removed during prescreening activities should be disposed of properly.
- ✓ S/S processes can produce gases, including vapors that are potentially toxic, irritating, or noxious (Freeman and Harris, 1995). Vapor treatment systems should be used to the extent possible to control the movement of these vapors.
- ✓ If volatile organics are present, off-gas capturing and treatment systems should be designed according to recommendations provided in Chapter 3.
- ✓ Reagent delivery piping should be regularly checked to ensure tight fittings. This will reduce the likelihood of releases of VOCs.
- ✓ Wastes should be homogenized as much as practicable before processing. This can improve the efficiency of the stabilization activities, and may

help to reduce spillage and other problems related to encountering irregular masses during the mixing process.

- ✓ Treated waste should be disposed in a covered area and above the groundwater table.

10.5.5 Waste Characteristics That May Increase the Likelihood of Cross-Media Contamination for Solidification and Stabilization Technologies

The effectiveness of solidification and stabilization technologies could be compromised and undue cross-media contamination may be caused under certain conditions identified in this subsection. However, some of these limitations could possibly be overcome with various technology-specific modifications and variations. Please refer to technology-specific references provided at the end of this chapter for additional information about modifications or variations that can be used to enhance the effectiveness of solidification and stabilization technologies.

- ▶ Physical mechanisms that can interfere with the S/S process include:
 - Incomplete mixing due to the presence of high moisture or organic chemical content resulting in only partial wetting or coating of the waste particles with the stabilizing and binding agents and the aggregation of untreated waste into lumps (Freeman and Harris, 1995).
 - Disruption of the gel structure of the curing cement or pozzolanic mixture by hydrophilic organics in the soil (Freeman and Harris, 1995).
 - Undermixing of dry or pasty wastes (Freeman and Harris, 1995).
- ▶ Chemical mechanisms that can interfere with the S/S process include:
 - Chemical adsorption
 - Precipitation
 - Nucleation
- ▶ Other factors that can interfere include:
 - Precise tailoring of waste composition to the S/S process used (USEPA, 1994c).
 - Waste containing oil and grease in moderate to high concentrations.

For more details on the various chemical interactions that can reduce the effectiveness, and thereby the stability, of S/S treatments, see Freeman and Harris, 1995, and USEPA, 1993b.

10.6 Excavation and Off-Site Disposal

10.6.1 Definition and Scope of Excavation and Off-Site Disposal (for BMPs)

When a site is remediated by excavation and off-site disposal, the contaminated material (typically a solid or semi-solid material such as soil or sludge) is excavated, then transported off-site for treatment and/or disposal.

10.6.1.1 Key Features of Excavation and Off-Site Disposal for the Purpose of BMPs

- Excavation or collection of contaminated soils, followed by piling or mixing of the soils.
- Containerization or temporary storage of the contaminated soils or solid media.
- Shipping of soils off-site for disposal.
- Field applications involve installation of a temporary canopy, liner, or other physical barrier as presented in Chapter 3 that minimizes movement of materials from the site by wind, water, or any other mechanism.

10.6.2 Excavation and Off-Site Disposal Technology Description

Excavation and off-site disposal primarily involve equipment that is widely used in the construction or non-hazardous solid waste disposal industries, such as excavators, earth movers or backhoes, dump trucks, and containers of various shapes, sizes, and materials. However, in general, hazardous waste excavation and off-site disposal activities require significantly more attention to personal protection and safety, including provisions for worker protection (special clothing, decontamination techniques, etc.) and equipment decontamination.

10.6.3 Cross-Media Transfer Potential of Excavation and Off-Site Disposal

(a) General

The general cross-media concerns that are provided in Chapter 2, especially those that refer to excavation and construction activities, are especially relevant to this technology. Table 2-1 presents information on the contribution of remedial activities, including excavation, materials handling, and transportation, that are of concern to all remedial technologies including this option.

(b) Additional Concerns for Excavation and Off-Site Disposal

Concerns for excavation and off-site disposal center around the potential for cross-media transfer during materials handling and transportation activities. Careful attention should be paid to information presented in those chapters, particularly as it relates to the handling and transportation of contaminated wastes.

10.6.4 Best Management Options to Avoid Potential Cross-Media Transfers During Excavation and Off-Site Disposal

General BMPs to prevent potential cross-media transfer of contaminants during excavation and off-site disposal activities have been addressed in Chapters 2 and 3. The BMP options presented in those chapters are most applicable to this technology. They include:

- ✓ Entry to the active site should be limited to avoid unnecessary exposure and related transfer of contaminants, especially during site preparation and staging.
- ✓ Avoid entering the contaminated area. In unavoidable circumstances, build a temporary decontamination area, which could be later used during cleanup activities. Any above-ground and underground source of contaminants should be identified and located prior to starting excavation of the contaminated area.
- ✓ Fugitive dust emissions should be controlled during excavation by spraying water or other materials to keep the ground moist or covered. During wet weather or rainfall no water spraying would be needed. See Chapter 3 for more information on materials that can be used to control fugitive dust emissions.
- ✓ During transportation of contaminated soils or solid media, covers or liners should be used to prevent dust and VOC emissions. These temporary covers on trucks or other hauling equipment should be installed with care to minimize possibilities for the waste to come into contact with high winds during transport.
- ✓ Any offsite runoff should be prevented from entering and mixing with on-site contaminated media by building earthen berms or adopting similar other measures, as outlined in Table 3-4.
- ✓ Provisions should generally be made to capture on-site surface water runoff by diverting it to a controlled depression-area or lined pit.
- ✓ Covers, and if necessary, liners, should be used at all times when contaminated materials are being stored. Covers should be used on trucks that are moving materials around and from the site. See Chapter 3 for details on covers and liners that should be considered for use during excavation, storage, and transportation.

10.6.5 Waste Characteristics that May Increase the Likelihood of Cross-Media Contamination for Excavation and Off-Site Disposal Technologies

Under the following conditions the effectiveness of excavation and off-site disposal (for BMPs) could be compromised, and could cause undue cross-media contamination.

- ▶ When high volumes of soils are to be disposed of, this option may not be very cost-effective.
- ▶ For highly explosive materials, a simple excavation and disposal may not provide the safest method of handling the waste.

10.7 References

1. Campbell, Brett E. 1995. Geosafe Corporation, Comments on BMP Workshop Summary- Other Physical/Chemical Technologies, Personal Communication to Subijoy Dutta, USEPA.
2. Dev, Harsh. 1995. IIT Research Institute, Letter Report on RF In Situ Heating and Soil Decontamination Process, Personal Communication to Subijoy Dutta, USEPA.
3. Freeman, Harry M. and Eugene F. Harris. 1995. Hazardous Waste Remediation: Innovative Treatment Technologies, Technomic Publishing Co., Inc., Lancaster, PA.
4. USEPA. 1995a. SITE Technology Capsule: IITRI Radio Frequency Heating Technology, EPA/540/R-94/527a, March.
5. USEPA. 1995b. Innovative Technology Evaluation Report, Radio Frequency Heating, KAI Technologies Inc., EPA/540/R-94/528, April.
6. USEPA. 1995c. In Situ Remediation Technology Status Report: Surfactant Enhancements, EPA/542-K-94/003, Office of Solid Waste and Emergency Response.
7. USEPA. 1995d. In Situ Remediation Technology Status Report: Cosolvents, EPA/542-K-94/006, Office of Solid Waste and Emergency Response.
8. USEPA. 1995e. In Situ Remediation Technology Status Report: Hydraulic and Pneumatic Fracturing, EPA/542/K-94/005, Office of Solid Waste and Emergency Response.
9. USEPA. 1995f. In Situ Remediation Technology Status Report: Electrokinetics, EPA/542/K-94/007, Office of Solid Waste and Emergency Response.
10. USEPA. 1995g. Dynaphore Inc. Forager Sponge Technology, Innovative Technology Evaluation Report, EPA/540/R-94/522, Office of Research and Development, Washington, DC, June.
11. USEPA. 1995h. Geosafe Corporation In Situ Vitrification Innovative Technology Evaluation Report, EPA/540/R-94/520, Office of Research and Development, Washington, DC, March.

12. USEPA. 1995i. IITRI Radio Frequency Heating Technology, Innovative Technology Evaluation Report, EPA/540/R-94/527, Office of Research and Development, Washington, DC,
13. USEPA. 1995j. SITE Emerging Technology Summary, Reclamation of Lead from Superfund Waste Material Using Secondary Lead Smelters, EPA/540/SR-95/504, Center for Environmental Research Information, Cincinnati, OH.
14. USEPA. 1995k. SITE Emerging Technology Bulletin, Waste Vitrification Through Electric Melting, Ferro Corporation, EPA/540/F-95/503, Risk Reduction Engineering Laboratory, Cincinnati, OH, March.
15. USEPA. 1995l. SITE Emerging Technology Bulletin, Electrokinetic Soil Processing, Electrokinetics, Inc., EPA/540/F-95/504, Risk Reduction Engineering Laboratory, Cincinnati, OH, March.
16. USEPA. 1995m. SITE Technology Capsule, Texaco Gasification Process, EPA 540/R-94/514a, Center for Environmental Research Information, Cincinnati, OH. April.
17. USEPA. 1995n. SITE Technology Capsule, KAI Radio Frequency Heating Technology, EPA/540/R-94/528a, Center for Environmental Research Information, Cincinnati, OH, January.
18. Drennan, Dawn. 1994. Technical Answers, Lasagna Process Treats Contaminants. Environmental Protection, Stevens Publishing, Waco, TX, September.
19. USEPA. 1994a. Engineering Bulletin-In Situ Vitrification Treatment, EPA/540/S-94/504, Office of Research and Development, Cincinnati, OH, October.
20. USEPA. 1994b. Emerging Technology Bulletin, Institute of Gas Technology, Fluid Extraction-Biological Degradation Process, EPA/540/F-94/501, March.
21. USEPA. 1994c. William C. Anderson, ed. Innovative Site Remediation Technology, Solidification/Stabilization, Volume 4, EPA/542/B-94/001, Office of Solid Waste and Emergency Response.
22. USEPA. 1994d. Innovative Site Remediation Technology: Chemical Treatment, Volume 2, EPA/542/B-94/004, Office of Solid Waste and Emergency Response.
23. USEPA. 1994e. Physical/Chemical Treatment Technology Resource Guide, EPA/542/B-94/008, Office of Solid Waste and Emergency Response, Technology Innovation Office, Washington, DC.
24. USEPA. 1994f. SITE Demonstration Bulletin, SFC Oleofiltration System, InPlant Systems, Inc., EPA/MR-94/525, Risk Reduction Engineering Laboratory, Cincinnati, OH, October.

25. USEPA. 1994g. SITE Technology Capsule, InPlant Systems, Inc., SFC 0.5 Oleofiltration System, EPA/540/R-94/525a, Center for Environmental Research Information, Cincinnati, OH, December.
26. USEPA. 1993a. Innovative Site Remediation Technology: Soil Washing/Soil Flushing, Volume 3, EPA/542/B-93-012, November.
27. USEPA. 1993b. Technical Resource Document-Solidification/Stabilization and its Application to Waste Materials, EPA/530/R-93/012, Office of Research and Development, Washington, DC, June.
28. USEPA. 1993c. Accutech Pneumatic Fracturing Extraction and Hot Gas Injection, Phase I, Applications Analysis Report, EPA/540/AR-93/509, Office of Research and Development, Washington, DC, July.
29. USEPA. 1993d. Engineering Bulletin, Solidification/Stabilization of Organics and Inorganics, EPA/540/S-92/015, Office of Research and Development, Cincinnati, OH, May.
30. USEPA. 1992a. Guide for Conducting Treatability Studies Under CERCLA Solvent Extraction, Interim Guidance (and Quick Reference Fact Sheet), EPA/540/R-92/016A and B, Office of Emergency and Remedial Response, August.
31. USEPA. 1992b. Seminar Publication: Organic Air Emissions from Waste Management Facilities, EPA/625/R-92/003, August.
32. USEPA. 1992c. Guide for Conducting Treatability Studies Under CERCLA, Chemical Dehalogenation (and Quick Reference Fact Sheet), EPA/540/R-92/013A and B, Office of Solid Waste and Emergency Response, May.
33. USEPA. 1992d. Engineering Bulletin-Supercritical Water Oxidation, EPA/540/S-92/006, Office of Research and Development, Cincinnati, OH, September.
34. USEPA. 1992e. A Citizen's Guide to Glycolate Dehalogenation-Technology Fact Sheet, EPA/542/F-92/005, Office of Solid Waste and Emergency Response, Technology Innovation Office.
35. USEPA. 1992f. A Citizen's Guide to In Situ Soil Flushing-Technology Fact Sheet, EPA/542/F-92/007, Office of Solid Waste and Emergency Response, Technology Innovation Office.
36. USEPA. 1991a. Engineering Bulletin: Control of Air Emissions From Materials Handling During Remediation, EPA/540/2-91/023, October.
37. USEPA. 1991b. Engineering Bulletin-In Situ Soil Flushing, EPA/540/2-91/021, Office of Research and Development, Cincinnati, OH, October.

38. USEPA. 1991c. Engineering Bulletin-Chemical Oxidation Treatment, EPA/540/2-91/025, Office of Emergency and Remedial Response, Washington, DC, Office of Research and Development, Cincinnati, OH, October.
39. USEPA. 1991d. Engineering Bulletin-Granular Activated Carbon Treatment, EPA/540/2-91/024, Office of Research and Development, Cincinnati, OH, October.
40. USEPA. 1990. Engineering Bulletin-Chemical Dehalogenation Treatment: APEG Treatment, EPA/540/2-90/015, Office of Research and Development, Cincinnati, OH, September.

11.0 Chapter Eleven: FIELD VALIDATION and CASE STUDIES of BMPs

This chapter provides information on the field use of best management practices (BMPs) for controlling cross-media transfer of pollutants at sites where soils treatment has been completed or is currently under progress. The information was compiled with the following objectives:

- Provide highlights of BMPs observed at each site,
- Provide details on how certain BMPs were used at different sites,
- Compare recommended BMPs with the current practices in the field, and
- Incorporate new or modified BMPs in the relevant sections of the BMPs guidance.

The information contained in this chapter was developed by examining detailed site workplans and soils treatment reports, as well as by interviewing site remediation managers and observing remediation activities at volunteering sites. In total, information on the field use of BMPs was obtained from eight sites (located in the states of Colorado, Connecticut, Maine, Maryland, Minnesota, and Virginia) covering the following six types of soils treatment technologies: containment, soil washing/soil leaching, soil-vapor extraction, thermal treatment, bioremediation, and chemical based stabilization.

This field validation study was undertaken at a limited number of sites due to time constraints and ready availability of volunteering sites. However, after this guidance is used at various sites, EPA plans to contact additional volunteering sites from different parts of the country to get their experience with the recommended BMPs. This feedback would be incorporated in the next update of the BMPs guidance.

Table 11-1 summarizes key characteristics of the sites EPA studied to obtain information on the field use of BMPs. The first five case studies (Site Nos. 1-5) are based on records provided by state personnel who had acted as coordinators of RCRA Corrective Action Programs at the respective sites. These personnel also participated in EPA's RCRA National Program Meeting in September 1996 to discuss the BMPs used at the sites. The sixth case study (Site No. 6) is based on records provided by a federal contractor acting as the planner and coordinator of environmental restoration activities at the site. The last two case studies (Site Nos. 7 and 8) are based on information obtained by EPA during site visits when detailed discussions were held with site managers on their use of BMPs in remediation currently in progress.

Sections 11.1 through 11.8 provide details on the field use of BMPs at each site. Each section briefly describes site remediation activities at the site followed by a more in-depth description of the BMPs as used, and some views and discussion on the case study. Finally, Section 11.9 provides a summary list of selected BMPs used at each site and comparisons of those BMPs with the recommended BMPs in Chapters 4 through 10 of this guidance.

Table 11-1. Key Characteristics of BMP Case Study Sites

Site No.	Site and Treatment Details					
	Location	Type of Soil Contamination	Area/Depth of Soil Contaminated	Soil Treatment Technology	Volume of Soil Treated	Duration/Status of Site Remediation
1	Army Ammunition Plant, Minnesota	Metals	16 Acres/2 Feet Below Surface	Soil Washing/Soil Leaching	24,748 Tons	From 1993 to 1995
2	Petroleum Refinery, Minnesota	Petroleum-Derived Hydrocarbons	Two Lagoons 0.5 Acre/Up to 10 Feet	In Situ Soil Stabilization	18,000 Cubic Yards (10 Feet Depth)	Conducted in 1995
3	Closed Battery Manufacturing Facility, Virginia	Lead	Plant Site of 4.5 Acres/Up to 3 Feet	Ex Situ Soil Stabilization	25,578 Cubic Yards	Conducted in 1993
4	Previously Used Ammunition Testing/Disposal Site, Connecticut	Metals (Primarily Lead)	Scattered Distribution of Contaminated Areas Over 435 Acres/Mostly on Surface	Size Separation/Soil Washing	1,000 Cubic Yards (40,000 Cubic Yards Planned for Field Scale)	Pilot Study Completed in 1995
5	Closed Electronics Component Manufacturing Facility, Maine	Spent Organic Solvents	Below a Building, 3 Acre Site	Soil Vapor Extraction	Estimated 40,000-50,000 Cubic Yards	In Progress from 1995
6	DOE Manufacturing Facility, Colorado	VOCs in Subsurface Soil	Two Trenches Each Up to 4,000 Square Feet, 10 Feet Deep	Ex Situ Thermal Desorption	2,200 Cubic Yards	Conducted in 1996
7	Closed Chromium Manufacturing Facility, Maryland	Chromium	15-20 Acres; Up to 80 Feet or Bedrock	Site Containment	Estimated 1-2 Million Cubic Yards	In Progress from 1991
8	DoD Manufacturing Facility, Virginia	Explosives-Derived (Organic) Compounds	300 Foot Long Drainage Area; 4-5 Feet Wide	Ex Situ Bioremediation	500 Cubic Yards	In Progress from Summer 1996

11.1 Soil Washing/Soil Leaching to Treat Metals Contaminated Soil at an Army Ammunition Plant in Minnesota (Site 1)

11.1.1 Description of Site Remediation Activities

From 1993 through 1995, metals contaminated soil was excavated from an area of 16 acres in an Army ammunition plant in Minnesota and treated, when possible, by soil washing/soil leaching on site. The treatment goals were to reduce the concentration of lead to a regulatory level of 300 mg/kg and the concentration of several other heavy metals to the background levels. The site was previously used as an open burning area for scrap primers, fuses, and explosives related to small caliber arms and rifle grenades. The metals contamination was generally limited to the uppermost three feet across the site. The site was not contaminated with VOCs, SVOCs, or cyanide. The groundwater was not impacted by soil contamination. However, twenty disposal areas were identified at this site which were also excavated and remediated. The materials found in the disposal areas included ordnance, high explosive items, cast-iron pots, crushed drums, characterized chemical substances, and miscellaneous scrap metal, wood, concrete and glass debris. All materials excavated from the disposal areas were identified and sorted for proper treatment or disposal off site.

The site remediation was performed according to closure plans approved under a RCRA Hazardous Waste TSD Permit and the Federal Facility Agreement (FFA) prepared for the Installation Restoration Program (IRP) of the Army ammunition plant. The site closure activities included site preparation, disposal area investigations and excavation, metals-contaminated soil excavation and treatment, ordnance clearance, hazardous and non-hazardous waste management, and site restoration to allow unrestricted future use of the site.

Approximately 24,748 tons of contaminated soil were excavated at this site. A total of 246 tons of metal concentrate were recovered during soil washing/soil leaching activities. A total of 12,797 tons of soil were successfully treated and backfilled as clean soil. A total of 7,125 tons of soil were treated to become non-hazardous and these wastes are temporarily being stored on site. Approximately 4,555 tons of soil, characterized as hazardous and non treatable on site, were recycled off site at a smelter.

11.1.2 BMPs Used to Prevent Cross-Media Transfer of Pollutants

Because the remediated site was located in a large federal facility (2,300 acres) where several private companies operated as facility tenants, there was a potential for human exposure to lead and other toxic metals from fugitive dust emission during site excavation, soil transportation and soil treatment. There was also a potential for cross-media transfer of pollutants in uncontrolled surface water run-on to and run-off from the site. Another concern was that a spillage and/or improper disposal of soil treatment residuals might result in groundwater contamination. To address these cross-media transfer concerns, various BMPs were used at this site during site remediation. A list of 12 BMPs, as introduced in different remedial stages, is given below.

Site Preparation and Staging

- a. Delineating the actual limits of soil contamination by lead and other heavy metals.
- b. Establishing an exclusion zone and a decontamination pad to control all traffic to/from the site.
- c. Refurbishing the existing oil treatment pad/area to meet the staging needs of soil washing/soil leaching on site.
- d. Conducting an in-depth characterization of new disposal areas located on site.
- e. Removing and sorting the debris found in disposal areas.
- f. Installing an air quality monitoring system at the site.

Pre-Treatment

- g. Building an earthen berm for controlling surface water run-on to and run-off from the site.
- h. Arranging for dust suppression during site remediation.
- i. Covering haul trucks and excavated soil stockpiles.

Soil Treatment

- j. Reusing stormwater as process makeup water.
- k. Recycling process wastewater in soil treatment.

Post-Treatment

- l. Reusing treated/clean soil in restoring the site.

Additional details on the field application of each of these BMPs are given below.

a. Delineating the Actual Limits of Soil Contamination by Lead and Other Heavy Metals. Additional soil boring and field analysis of total lead concentrations were performed as one of the earliest activities of site remediation in 1993 to further delineate the previously estimated limits of soil contamination. A total of 326 soil borings were made to collect soil samples at 6- and 12-inch depths every 25 feet along the estimated limits. X-ray fluorescence (XRF) analysis was used to give a field determination of soil quality. If samples from both depths at a given soil boring were shown to have XRF lead concentrations of less than 100 ppm, the location was considered to be non-contaminated. Additional XRF samples were then collected in an attempt to delineate the boundary of contamination within five feet of the actual zone of contamination (which also represented the horizontal limits of excavation). These activities limited the total quantities of soil excavated and treated during site remediation.

b. Establishing an Exclusion Zone and a Decontamination Pad to Control All Traffic To/From the Site. After verifying the boundaries of contamination with laboratory analysis of soil samples, the exclusion zone was established by providing a buffer zone outside the finalized limits of contamination. Access to the exclusion zone was limited to qualified personnel wearing the appropriate personnel protective equipment and to perform only the site remediation activities approved by the site closure plan. After

establishing the exclusion zone, a decontamination pad was constructed for vehicle, equipment, and personnel decontamination. All traffic into and out of the exclusion zone went through the decontamination pad. The decontamination pad was a 6-inch thick asphalt pad underlain with gravel subbase. The pad was constructed with a 3-inch high asphalt berm around the perimeter to control run-off and run-on. All water used in the decontamination pad was collected in a 100-gallon sump. Both the pad and sump were coated with sealant to help prevent any seepage of contaminated water. Two 8-foot high wind walls were constructed to minimize decontamination spray from migrating off the pad. A fully enclosed personnel decontamination area was also constructed on the decontamination pad. The construction of a decontamination pad with all these features enabled the facility to effectively manage any release of pollutants taking place during the excavation and/or transportation of contaminated soil at the site.

c. Refurbishing the Existing Oil Treatment Pad/Area to Meet the Staging Needs of Soil Washing/Soil Leaching on Site. An existing concrete pad located near the site was utilized for soil washing and soil leaching operations. The concrete pad was 6 to 8 inches thick and had masonry block walls. The pad was used, however, only after preparing it for soil washing/soil leaching equipment. The soil feed section of the pad used for stockpiling contaminated soil was completely resurfaced with adequate slope for drainage of water to a sump. Several large, deep cracks existing in other portions of the treatment pad were also sealed to further ensure containment of pollutants released from the soil and soil treatment process chemicals used on the pad. A new drive-over curb was constructed to prevent contaminated water generated in the soil washing area from entering the treated soil storage area. These preparatory efforts enabled the facility to effectively contain any release of pollutants taking place during soil treatment on site.

d. Conducting an In-Depth Characterization of New Disposal Areas Located on Site. Prior to any soil excavation activities, a certified explosives and unexploded ordnance contractor performed a visual ordnance survey within the exclusion zone. Based on the quantity of ordnance identified on the surface of the site, it was decided to take up additional investigative work on site. A magnetometer survey performed across the site identified 24 soil anomalies. Investigative test trenching at the locations of these anomalies and other suspect areas identified 11 disposal areas. Nine more disposal areas were identified following excavation of metals contaminated soils through a review of historical aerial photographs or verification test trenching.

e. Removing and Sorting the Debris Found in Disposal Areas. The disposal areas were excavated before starting the excavation of metals contaminated soils. As a result, the metals contaminated soils were segregated from the debris buried in the disposal areas (these materials were untreatable by soil washing/soil leaching). The materials found in the disposal areas included high explosive items with approximately ten pounds of explosives. These items were detonated at two locations on site. All other debris were sorted and sent off site for recovery or disposal.

f. Installing an Air Quality Monitoring System at the Site. The health and safety program at this site included the monitoring of specific air pollutants during the entire period of remediation at disposal areas, metals contaminated soil excavation, and on-site treatment of soil. For example, the investigative test trenching and disposal area

excavation were conducted without encountering hazardous ambient conditions or action level exceedances for airborne lead, combustible gases, oxygen, total dust, and hydrogen cyanide. The maximum level of total dust was 0.070 mg/cu.m. (action level = 0.30 mg/cu.m.). The maximum airborne lead was 0.009 mg/cu.m. (action level = 0.03 mg/cu.m.). The air quality monitoring was performed along with the monitoring of other air-borne pollutants, such as noise and heat stress in the work areas.

g. Building an Earthen Berm for Controlling Surface Water Run-On to and Run-Off From the Site. A soil berm approximately three feet wide and two feet high was constructed immediately outside the exclusion zone. The berm was 1,330 linear feet and completely surrounded the site. The berm was constructed to contain contaminated stormwater precipitating on the site as well as to prevent surface water from flowing into the exclusion zone.

h. Arranging for Dust Suppression During Site Remediation. In preparation for encountering adverse working conditions, the site was provided with adequate dust control measures. These measures included a 1.5-inch PVC water line constructed along the site access road with sprinklers tapped into the line every 25 feet. The line was used to wet the road, thereby minimizing fugitive dust along the road during the transportation of contaminated soil to the treatment pad. A 3/4-inch black PVC water line was also run along the boundary of the exclusion zone with valves located every 100 feet to provide the entire site with an access to water.

i. Covering Haul Trucks and Excavated Soil Stockpiles. The excavated surface soils were hauled from the site to the treatment pad in dump trucks covered with a tarp to prevent spillage and dust emission. The transported soil was stored in the stockpile area of the treatment pad. Additional quantities of excavated soil were stockpiled within the exclusion zone near the decontamination pad. Stockpiles were maintained only to provide adequate quantities for continuing on-site treatment operations. These soil stockpiles were covered with reinforced plastic sheets to prevent fugitive dust emission and rainwater infiltration. The same contaminated soil handling procedures were used for excavation and transport of soils from the disposal area, as well.

j. Reusing Stormwater as Process Makeup Water. The stormwater run-off from the impervious soil treatment pad was collected in a 20,000 gallon holding tank. Stormwater was also collected in sumps provided in the soil storage pad. To the best extent possible, water in the holding tank was used as makeup water in the soil treatment process and thereby eliminated the need for additional treatment of the contaminated stormwater.

k. Recycling Process Wastewater in Soil Treatment. Process water used in soil washing/soil leaching was normally recycled throughout the project. Recycling of the process water minimized generation of process wastewater.

l. Reusing Treated/Clean Soil in Restoring the Site. The successfully treated soil was used to backfill the site; the site was regraded, provided with clean top soil and revegetated for better soil erosion control. By using treated soil in restoring the site, it was possible to prevent disposal of large quantities of excavated soil (with residual contamination) off site.

11.1.3 Views and Discussion

In addition to the practices listed above, efforts were taken to minimize the need to dispose of hazardous treatment residuals off site. In the first year of site remediation (1993), for example, batches of soil that did not meet treatment standards for any of the heavy metals of concern were hauled back to the contaminated soil feed pad for reprocessing. These batches were placed in stockpiles where some mixing with other soils occurred. The batches failing to meet treatment standards in 1994 and 1995 were first assessed to determine the likelihood of being managed as non-hazardous waste. When the TCLP results indicated that the soil was non-hazardous, then the batch was transported to a separate soil storage pad. Other batches failing to meet treatment standards were disposed off-site.

The soil treatment residuals also included metal concentrates generated in the density separation stage and electrowinning unit of the soil washing/soil leaching process. The metals concentrates were accumulated in drums and manifested to a smelter for metal recovery. Treated soil found to be hazardous was sent off site for metal recovery.

Following completion of soil excavation and treatment activities, the decontamination pad built near the site was excavated and treated. (Wipe samples were collected on the surface of the decontamination pad prior to the commencement of any work and after completing all work on the pad.) The material excavated from the pad was then disposed of as non-hazardous waste.

11.2 In-Situ Chemical Based Stabilization of Petroleum Contaminated Soil at a Refinery in Minnesota (Site 2)

11.2.1 Description of Site Remediation Activities

In 1995, two previously used biological treatment facilities (aeration lagoons), part of a refinery's wastewater treatment plant in Minnesota, were closed after implementing in situ chemical based stabilization for approximately 18,000 cubic yards of petroleum contaminated soil at the facilities. Both lagoons had occupied the eastern portion of an area of fill between a bedrock escarpment and the Mississippi River. The topography of the fill was relatively flat, rising slightly to the north. The original lagoon bottoms were approximately 15 to 20 feet below the ground surface nearby and lagoon elevations were normally at the same level as the river.

Both lagoons were identified in 1990 to be hazardous waste management facilities due to the occasional presence of benzene in concentrations exceeding the toxicity characteristic limit in the wastewater entering the first of two lagoons which were in series. A RCRA Part B permit application to continue operation of the lagoons was then submitted to EPA and the Minnesota Pollution Control Agency (MPCA). However, it was decided to permanently close the existing facilities subsequent to the initiation of a groundwater monitoring program in the vicinity of the lagoons and investigation of the pollutants in the subsoil in both lagoons. A partial stabilization of the subsoil in the lagoons was then performed by mixing the top two to six feet of subsoil with cement using a track-mounted backhoe equipped with injector tines. Based on the results of subsoil

investigation conducted after these preliminary soil remediation efforts, it was decided to perform additional stabilization of subsoil in the lagoons. The refinery submitted a revised closure plan for the two lagoons in 1994 and finally amended the revised closure plan early in 1995.

Pursuant to the closure plan approved under RCRA, the subsoil in both lagoons was stabilized in situ by utilizing a mixture of portland cement and fly ash (20:80 percent) as a stabilizing agent or grout to reduce the potential for leaching the VOCs, SVOCs and metals from the stabilized materials. The stabilization matrix is also expected to reduce the generation of leachate and prevent the long-term release of organic compounds to the groundwater from the soil underlying the stabilized materials in the lagoons. In situ grouting of subsoil was performed by drilling into the subsoil with a 10-foot diameter auger and mixing the soil in the borehole with grout as the auger was retrieved. At each drilling and grouting location, a column of stabilized material of low permeability was created which contained and immobilized contaminants within the soil. Prior to the implementation of this soil treatment process, the lagoons were emptied of oily sludge and wastewater.

11.2.2 BMPs Used to Prevent Cross-Media Transfer of Pollutants

There was a potential for surface water pollution in the initial stages of remediation at this site (e.g., removal of large quantities of oily sludge and wastewater from the lagoons before commencing soil treatment) due to the close proximity of a river to the site. Moreover, soil contamination at the site had adversely impacted groundwater in the area and the quality of groundwater had to be monitored for several years to determine if soil treatment had been effective. The following five BMPs were used to prevent cross-media transfer of pollutants during the RCRA cleanup program at this site:

Site Preparation

- a. Removing and containing liquid wastes found at the site.

Pre-Treatment

- b. Arranging to prevent surface water run-on to the site.

Soil Treatment

- c. Treating stormwater collected on site prior to disposal.
- d. Conducting additional soil tests to determine the effectiveness of soil stabilization.

Post-Treatment

- e. Monitoring groundwater to determine the effectiveness of soil stabilization.

Additional details on the field application of each of these BMPs are given below.

a. Removing and Containing Liquid Wastes Found at the Site. Oily sludge and wastewater were removed from the lagoons prior to soil remediation were collected in portable tanks. Earthen berms (1' high by 3' wide) surrounded each portable CAMU Padtank. A poly tarp was placed on the ground and berms before the portable tanks were set in place. The earthen berms and poly tarp were provided to address concerns of spills of the process treatment residuals occurring near the tanks. (The tanks were placed outside the remediation site and near a sharply sloped river embankment.)

b. Arranging to Prevent Surface Water Run-On to the Site. The lagoons were bound on three sides with man-made dikes and on the fourth side by a 20 feet natural escarpment. The higher ground beyond the escarpment was occupied by the refinery which was on a well-paved, graded and diked area. Because the soil stabilization area was in a floodplain of the Mississippi River, the top of the west dike facing the river was elevated by 3 feet as additional precaution against flooding during spring time.

c. Treating Stormwater Collected on Site Prior to Disposal. There was ample freeboard (13 feet) to prevent run-off from the soil stabilization area. The accumulated stormwater was pumped for treatment to an adjacent wastewater treatment plant. The pumps and wastewater treatment plant had adequate capacity for this purpose.

d. Conducting Additional Soil Tests to Determine the Effectiveness of Soil Stabilization. Confirmatory soil sampling was conducted to obtain additional information on the depth of soil stabilization and soil quality. The soil samples were examined visually and for odor, and screened for organic vapors using the jar headspace method. The stabilized materials and unstabilized subsoils below stabilized materials were then analyzed to determine the leachability of organics and metals present in the samples.

e. Monitoring Groundwater to Determine the Effectiveness of Soil Stabilization. If the stabilization matrix became less effective over time, the VOCs and SVOCs released before site remediation would be observed at increasing concentrations in the groundwater near the site. A groundwater demonstration monitoring was started after completing soil stabilization at this site. This activity included regular monitoring of groundwater sampled at wells up and down gradient of the lagoons, as well as in aquifers near the river. The closure plan for the site required groundwater monitoring every month during the first year, every quarter in the second and third year, and semiannually in the fourth and fifth year after the site remediation was completed.

11.2.3 Views and Discussion

At this site, there were opportunities for better addressing some of the major cross-media transfer concerns that existed. For example, the berms around the portable tanks used to collect and remove oily sludge and wastewater from the lagoons (see "a." in Section 11.2.2) were not high enough to protect against a major spill of the liquid waste being removed from site. In fact, the flexible hose from the lagoons to a tank became loose during remedial activity at this site and flopped out of the containment. Nearly 2,000 gallons of oily sludge spilled into the adjacent river before the spill could be stopped. If a site-specific emergency response plan was in place and implemented, it might have prevented a major spill in this incident.

The field screening and analysis of soil samples at both lagoons had shown the presence of petroleum hydrocarbons in relatively high concentrations, including VOCs like benzene and xylene and SVOCs like 2-methylnaphthalene and phenanthrene. Under these site conditions, fugitive emission of VOCs and other gases should be addressed by monitoring the volatilization of organic compounds during soil treatment. The soil stabilization process injected liquid slurry by means of an auger which avoided creating a large area of soil-air contact and the volatilization of organic compounds present in the soil. An air injection technology for the stabilizing agent might have resulted in significant air emissions of volatile organics. Under these conditions, it would have been appropriate to provide for collection and treatment of VOCs released from the site. Air quality monitoring could have also addressed release of VOCs from the stabilized soil.

Although some arrangements were made to prevent surface water run-on to the site (see "b." in Section 11.2.2), the worst likely run-on scenario (e.g., possible breach of the dike under a heavy flooding condition resulting in a wash out of the lagoon contents and some contaminated soils into the river) should be estimated in sites located within the floodplain.

11.3 Stabilization and Disposal of Lead Contaminated Soils at a Closed Battery Manufacturing Facility in Virginia (Site 3)

11.3.1 Description of Site Remediation Activities

In 1993, a phosphate-based stabilization technique was successfully performed on approximately 25,578 cubic yards of lead-contaminated soil and debris found in 11 acres of land at a closed battery manufacturing facility site in Virginia. The site was contaminated with lead concentrations in soil exceeding 100,000 mg/kg. The contaminated soil exhibited toxicity characteristics by virtue of the Toxicity Characteristics Leachate Procedure (TCLP) with lead concentrations in the leachate as high as 345 mg/l.

The phosphate-based stabilization process employed at the site significantly decreased the leachability of lead in soil to levels well below the regulatory threshold of 5 mg/l by virtue of TCLP, and produced a material disposable at greatly reduced costs. The soil remediation included excavating and mixing lead contaminated soil with triple superphosphate (TSP), water and magnesium oxide (MgO) in a pug mill. Lead phosphate, which has been shown to be among the least soluble and most stable forms of lead in the soil environment, was formed. The action level for deciding to treat most of the lead contaminated soils found at the site was kept at 1,000 mg/kg. Lower action levels were given for lead contaminated soils found in the drainage ditch and sedimentation basin used for stormwater control at the site (400 mg/kg) and in a previously used acid pond on site (250 mg/kg).

11.3.2 BMPs Used to Prevent Cross-Media Transfer of Pollutants

During the preparation of this site for remedial action, it was necessary to prevent any removal of contaminated soil from the site without appropriate treatment. Fugitive emission of dust containing lead and the "carry-over" of lead by stormwater run-off were the main concerns during pre-treatment and soil treatment at this site. The main

concern during post-treatment was the fact that action levels (1,000 mg/kg) for most of the site might have resulted in concentrations of lead in soil remaining at the site to be substantially higher than background levels. The facility addressed these concerns by using at least the following six BMPs:

Site Preparation and Staging

- a. Establishing site control zones to limit access to site.
- b. Performing site clearing and grubbing with limited off-site removal of pollutants.

Pre-Treatment

- c. Installing an air monitoring system and on-site weather station.
- d. Constructing a drainage ditch and sedimentation basin for stormwater run-off control.

Soil Treatment

- e. Modifying the process for treatment of soil from different areas of the site.

Post-Treatment

- f. Backfilling the excavated areas and site vegetation.

Additional details on the field application of each of these BMPs are given below.

a. Establishing Site Control Zones to Limit Access to Site. The site fence was relocated prior to any soil disturbance to provide security of the exclusion zone which contained all soils with lead concentrations above 1,000 mg/kg. Access to the exclusion zone was permitted only through the contamination reduction zone, where a pad was constructed to serve as a transfer location for all personnel and equipment to and from the exclusion zone. All decontamination water was collected and discharged to two 500-gallon settling tanks. The tanks were placed in series and facilitated the settling of sediments from the decontamination water. Lead and 10-micron particulate filters were installed on the discharge pipe of the second settling tank to ensure the adequate removal of suspended materials. The recycled water was then re-used for decontamination purposes. If water re-use was not possible, the decontamination water was disposed off-site. The filters were periodically replaced.

b. Performing Site Clearing and Grubbing with Limited Off-Site Removal of Pollutants. Prior to excavation activities, but after health and safety and environmental monitoring controls were emplaced, designated areas in the site were cleared and grubbed to minimize the off-site transfer of lead contaminated soils without treatment. All grubbed materials were decontaminated and then disposed off site. Other building structures on site were dismantled and decontaminated with a high pressure spray wash of water before the structures were disposed or recycled. This action also minimized the off-site transfer of lead contaminated soils without treatment.

c. Installing an Air Monitoring System and On-Site Weather Station. A Perimeter Air Sampling Program (PASP) was implemented to document the impact of on-site remedial action on the local ambient air quality. The critical concentrations to which ambient air sampling results were compared were 150 $\mu\text{g}/\text{cu.m.}$ for particulates less than 10 microns in diameter (PM-10) and 1.5 $\mu\text{g}/\text{m}^3$ for lead. The air monitoring was also used to ensure the effectiveness of dust control at the site. There was only one exceedance of the critical air concentrations during the entire site remediation period. It was determined to be due to fugitive dust caused by dry soil conditions and heavy truck traffic. Corrective actions were immediately taken by spraying additional water on excavated areas and stockpiled materials to suppress fugitive dust emission. An on-site weather station was used to control soil handling and excavation activities during high winds.

d. Constructing a Drainage Ditch and Sedimentation Basin for Stormwater Run-Off Control. The sedimentation basin was constructed to provide for the collection and recycling of contaminated runoff from the site and the settling of any contaminated sediment from stormwater run-off throughout the site remediation period. The basin was designed to retain runoff by providing two hours of retention time for all run-off generated by a 25-year, 24-hour storm event. The retention time was adequate to settle particles as small as 10 microns in diameter. Throughout the remedial process, collected stormwater was recycled from the sedimentation basin to the pug mill for inclusion within the solidification/stabilization process. This volume did not, however, constitute all of the make-up water for pug-mill operations; an unspecified volume was transported from off-site when the water level in the sedimentation basin was too low. Monthly samples of the water in the stormwater retention basin and quarterly samples of the surface-water which intermittently appeared in the drainage ditch, were collected and analyzed. The samples were used to confirm that off-site contamination of surface water had been prevented. Quarterly samples of the sediments were also taken in the drainage ditch upstream and downstream of the sedimentation basin. No significant change was found in the lead concentrations of the sediments obtained downstream of the sedimentation basin. As expected, lead concentrations increased in the sediments obtained throughout the period of site remediation from the drainage ditch upstream of the sedimentation basin.

e. Modifying the Process for Treatment of Soil from Different Areas of the Site. Excavation of soil for constructing the sedimentation basin was completed first, and the excavated soil was then separated into two storage areas: one area containing contaminated soils and the other area containing soils below the performance standard for lead of 1,000 mg/kg. The soil was then excavated from the remaining site, sampled and stored accordingly. (As noted earlier, the performance standard for soils found in the previously used acid pond was kept much lower at 250 mg/kg, and a performance standard of 400 mg/kg. was used for soils found in the drainage ditch and sedimentation basin after completing soil excavation and treatment in the remaining site.) By segregating the soil with lead above performance standards throughout the project, it was possible to minimize the total quantity of soil to be stabilized and transferred off-site for disposal. The areas used for stockpiling contaminated soil were the last to be excavated prior to pug mill dismantlement. With dismantlement of the pug mill, the surrounding areas used for staging, treatment and loading of treated soils were resampled, excavated and solidified or stabilized in roll-on containers, as required. Soils from the drainage ditch and the sedimentation basin were finally excavated and disposed. However, these soils were

stabilized in situ to avoid a transfer of contaminated water from the wet soils excavated at these locations in the site.

f. Backfilling the Excavated Areas and Site Vegetation. After receiving analytical results confirming that performance standards were achieved for all samples of soil and sediments obtained after treatment at the site, the excavated areas were backfilled with site soil that was found to be containing lead below 1,000 mg/kg, common borrow and a 6-inch thick layer of topsoil. Trees were planted in a portion of the area cleared during site preparation. All the disturbed areas on-site were subsequently hydroseeded. The original fencing alignment was restored at the conclusion of disposal operations, gated and locked. The background level of lead in soil for areas outside the site was found to be only 100 mg/kg. The proper restoration of the site, despite containment of lead contaminated soils above the background levels (between 1,000 and 100 mg/kg.), was an effective BMP as shown by surface water and groundwater monitoring being conducted after site remediation.

11.3.3 Views and Discussion

In addition to ambient air quality monitoring throughout the remedial action (see "b." in Section 11.3.2), this site conducted personal air monitoring during the startup of each new type of work activity to determine the potential personal exposure to lead. The action level for lead during personal air monitoring was $50 \mu\text{g}/\text{m}^3$ for an 8-hour time weighted average (TWA). Both ambient and personal air monitoring were performed in accordance with the Site Health and Safety Plan (SHSP), to determine that airborne lead concentrations on and off-site were within acceptable ranges.

11.4 Particle Size Separation and Soil Washing at a Site Used Previously for Ammunition Testing and Disposal in Connecticut (Site 4)

11.4.1 Description of Site Remediation Activities

Between September 1995 and November 1995, a pilot study was conducted at this site to evaluate soil washing and chemical leaching of contaminated soil excavated from several areas of environmental concern (AECs) in a large industrial property spread over 435 acres of wooded land. A total of 51 AECs, including 3 RCRA regulated units, were identified in the property. Preliminary evaluation of remedial alternatives had indicated that soil washing may be feasible as a soil treatment method in the majority (37 out of 51) of AECs. It was estimated that approximately 40,000 cubic yards of soil needed treatment at these AECs. The constituents of concern in the soil are inorganic metals (primarily lead). Organic constituents are not of particular concern because they were generally present at concentrations below the proposed RCRA corrective action levels. Soil composition and contaminant distribution varied significantly among the AECs, and in some cases, within each AEC. A pilot study was therefore required to determine a viable and cost-effective remedy which will be protective of human health and the environment.

The site applied for a Corrective Action Management Unit (CAMU) status for an area adjacent to one of the AECs to facilitate the storage and processing of soil from various AECs during the pilot study. EPA approved this request in October 1994 and a paved pad was constructed for management of excavated soil and treated soil at the CAMU. The pilot

study was conducted at the CAMU pad and included soil washing runs at varying feed rates (based upon the amount of particulate lead, physical characteristics, and organic material present in the soils) obtained from different AECs. The treatment goal of each soil washing run was to reduce total lead content to 1,000 mg/kg, as well as to meet the TCLP or SPLP levels for determining the treated soil to be non-hazardous. Chemical leaching was conducted on feed soils with high total lead content (10,000 mg/kg) and on a few batches of residuals from soil washing not meeting the treatment goals for TCLP/SPLP. In addition to a pilot study of soil washing/soil leaching, the site conducted a pilot study of processing the shotgun shells separated from the contaminated soil during soil washing pilot runs.

The pilot study found that soil washing provided an optimized and steady-state processing of soil with varying characteristics excavated from the AECs. Based on the results of the pilot study and a comparison of treatment alternatives, soil washing was recommended for full-scale operations at the site. A few process changes and alternative risk based treatment criteria were also recommended by the study. The existing CAMU has also been recommended, with a few modifications, for use in full-scale soil washing operations at the site.

11.4.2 BMPs Used to Prevent Cross-Media Transfer of Pollutants

During the pilot study involving soil excavation at AECs and soil treatment operations at the CAMU, the following concerns for cross-media transfer of pollutants existed: (i) the migration of contaminants like lead, mercury, strontium, asbestos, etc. as dust from different work areas, and (ii) surface water/groundwater contamination with metals and organics released from the soil during soil washing and chemical leaching operations. The pilot study was therefore designed to address these concerns while evaluating alternative soil treatment methods for their performance in meeting the treatment goals. Accordingly, the following six BMPs were used during the pilot study:

Site Preparation and Staging

- a. Monitoring of air quality at AECs and the CAMU pad.
- b. Installing a new CAMU pad for soil treatment operations.

Pre-Treatment

- c. Arranging for dust suppression at AECs and the CAMU pad.
- d. Providing covered and lined roll-offs for managing soil treatment residuals.

Soil Treatment

- e. Collecting and treating stormwater run-off from the CAMU pad and wastewater from soil treatment processes.

Post-Treatment

- f. Monitoring groundwater upgradient/downgradient of site.

Additional details on the field application and effectiveness of each of these BMPs are given below.

a. Monitoring of Air Quality at AECs and the CAMU Pad. During the pilot study, both air sampling and real-time monitoring of air quality were performed for lead, total dust and other contaminants. Baseline samples were collected at the perimeter of each area before start of operations to obtain background data. Then, air sampling was performed over the entire period of operations during each day in the area of interest. The air samples were sent to a laboratory approved by the American Industrial Hygiene Association (AIHA) which used NIOSH or OSHA methods. Typically, air samples were taken downwind of the area of interest. In some cases, samples of air were also taken upwind of the area. Real-time monitoring of total dust in the air was conducted periodically at upward and downwind locations during soil excavation at AECs. Monitoring of total dust was performed by an aerosol monitor to determine the concentrations of particulates in air. A photo-ionization detector (PID) was used to periodically screen VOCs in soil during excavation activities at AECs. Real time monitoring of total dust and mercury was performed every 30 minutes around the CAMU pad.

b. Installing a New CAMU Pad for Soil Treatment Operations. The CAMU pad was designed to store the following major types of soils/soil fractions (until the completion of sampling and analysis to determine their future management) in full scale operations: excavated soil, trommel oversize materials, wet-screen oversize materials, "clean" coarse-grained sand and the concentrated fine-grained materials. The area for storage of concentrated fine-grained material was provided with a concrete base and containment berms. This area was also given adequate slope to a sump capable of collecting excess water or stormwater run-off from the materials. The oversize materials were stored in a lined storage area segregated by an earthen berm. The soil stockpiles were also stored in a lined storage area with an earthen berm. However, this liner was protected from vehicular traffic by a 6-inch layer of sand and a 3-inch layer of gravel. Closure of the staging area for excavated soil will include removal of the gravel, sand and flexible-membrane liner placed on ground.

c. Arranging for Dust Suppression at AECs and the CAMU Pad. The site controlled airborne metals by suppressing dust during soil excavation at and during transportation of soil from AECs. This involved spraying water in the excavation areas and on transported soil. Watering trucks were used for dust suppression in remote areas of the site. The trucks used for transporting the soil were also kept covered as a method of dust suppression. Because of the presence of lead in the soil being treated, the Health & Safety Plan for the pilot study required the provision of adequate dust control measures in the CAMU pad. However, a significant emission of dust did not occur in soil-washing itself because the materials were kept wet during the process. The stockpiles of soil in the CAMU pad were either sprayed with water or kept covered with tarp as a dust suppression measure. Water supply to the CAMU pad is provided by a fire hydrant line in the main manufacturing plant.

d. Providing Covered and Lined Roll-Offs for Managing Soil Treatment Residuals. The residuals of soil-washing included contaminated fine-grained material which was kept stored preferably in covered and lined roll-offs to prevent leaching of metals and to control dust emission.

e. Collecting and Treating Stormwater Run-Off From the CAMU Pad and Wastewater From Soil Treatment Processes. During soil washing operations in the CAMU pad, the rainwater accumulated in the excavated soil storage area was pumped out into the soil-washing process. The area used for storage of oversize materials generated wastewater during the high pressure water/steam cleaning process. This wastewater was collected in catch basins and treated in a plant existing on site. Soil particles separated from the oversize materials were processed through the soil-washing system. The stormwater collected in the fine-grained material storage area was analyzed first to determine the level of contamination and then treated either on site or off site.

f. Monitoring Groundwater Upgradient/Downgradient of Site. Groundwater sampling was conducted quarterly prior to, during and after completing the pilot study at the site. For this purpose, two existing groundwater monitoring wells downgradient of the site were used. Analytical data compiled over a period of four quarters at these wells showed no evidence of an impact on groundwater quality due to the metals or VOCs released during soil-washing operations conducted in the pilot study.

11.4.3 Views and Discussion

Area and personal samples were also collected in the CAMU pad during the period of soil-washing or shotgun-shell processing operations. The parameters sampled during the pilot study included lead, total dust, mercury, strontium, acetic acid and asbestos -- i.e., all contaminants of concern known to be present in the materials being processed in the CAMU pad.

Based on the initial results of air sampling at the CAMU and AECs, which showed the presence of mercury in air at elevated levels, real-time monitoring for mercury was conducted at the property fenceline for a brief period of time in the pilot study. A gold film type mercury vapor analyzer was used for this purpose. Readings were taken both upwind and downwind of the potential or suspected sources of mercury emission during activities within the property. Background mercury data were also collected. The results showed no public exposure risk due to release of mercury during site remediation activities.

Based on the performance of soil treatment methods and field evaluation of cross-media transfer of pollutants during the pilot study, several BMPs will be modified in full-scale operations at this site. For example, it was decided to conduct only real-time total dust monitoring on a periodic basis and biweekly air sampling for lead and total dust during full-scale excavation activities at AECs and soil washing operations at the CAMU pad. Only periodic personal and area sampling of air will be performed in the CAMU pad: for lead and total dust during soil washing, and for asbestos during shotgun-shell processing operations. It was also decided to eliminate the monitoring of mercury in full-scale operations.

Other BMPs used in the pilot study that may require changes in full-scale operations include technologies applied for long term storage of excavated soils and treatment residuals on site. For example, the use of heavy duty poly tarpaulin covers secured with sand bags in the pilot study to cover re-wash soils may have to be replaced with other media for covering soils, such as foam coverings, wind screens, and/or water

sprays with additives (see Table 3-2 for more details). The full-scale operations at this large site would probably require the monitoring of surface waters in the area like creeks, streams and wetlands.

11.5 Soil Vapor Extraction of Solvents at a Closed Electronic Component Manufacturing Facility in Maine (Site 5)

11.5.1 Description of Site Remediation Activities

From March 1995, except for a shutdown during the coldest periods of winter in 1995 and 1996, a full-scale system for soil-vapor extraction (SVE) has been in operation at this site to treat the soil below the main building at the facility. The soil contamination occurred during previous manufacturing operations when spent solvents leaked from a corroded piping used to transport the solvent wastes to an underground tank outside the building. The soil below the main building was found to contain several VOCs like trichloroethene (TCE), tetrachloroethene (PCE), ethyl benzene, xylenes and 1,1,1-trichloroethane. During the last several months of operation, the concentration of VOCs in the influent to the SVE system has reduced from 1,200 ppm to less than 25 ppm. The off gases generated by the SVE system are processed through granular activated carbon (GAC), which is then regenerated on site in a mobile steam unit. The steam stripping also recovers light and heavy DNAPLs originally contained in the off gases. The full scale system was installed after conducting a range of investigations on site (e.g., soil borings and soil gas survey, surface water and groundwater sampling, and records search of chemicals used and building construction on site). A SVE pilot program was also conducted on site before starting the full-scale operations.

11.5.2 BMPs Used to Prevent Cross-Media Transfer of Pollutants

There was only a limited opportunity for cross-media transfer of pollutants from the operation of SVE at this site due to the confinement of contaminated soil and off gases below the main slab of the existing building. However, SVE pilot testing at this site helped to better define the potential for release of off gases at various points away from the SVE facility and the need for proper management of the contaminants (VOCs and DNAPLs) in the off gases generated by the SVE system. Accordingly, the site used the following three BMPs:

Site Preparation and Staging

- a. Containerization of drill cuttings.
- b. Ambient and workspace air monitoring for VOCs.

Soil Treatment

- c. Recovering DNAPLs from soil-vapor.

Additional details on the field application of each of these BMPs are given below.

- a. Containerization of Drill Cuttings. The soil monitoring points and SVE wells installed on site involved the excavation of contaminated soils. In order to control the

emission of VOCs during these activities, soil borings and drilling were performed with an appropriate containerization of cuttings.

b. Ambient and Workspace Air Monitoring for VOCs. Ambient air monitoring of VOCs was performed with a PID to ensure that Maine's state interim guidelines are being met for the maximum ambient air concentrations of TCE ($2 \mu\text{g}/\text{m}^3$), PCE ($0.1 \mu\text{g}/\text{m}^3$), ethyl benzene ($1,000 \mu\text{g}/\text{m}^3$), xylenes ($300 \mu\text{g}/\text{m}^3$), and 1,1,1-trichloroethane ($1,000 \mu\text{g}/\text{m}^3$). This activity also enabled a check of emission control measures installed in the SVE system. Workspace air monitoring of VOCs was performed with a PID to ensure protection of worker health and safety. By comparing the workspace air quality with the influent concentration of VOCs, it was possible to check the general performance of the SVE system.

c. Recovering DNAPLs from Soil Vapor. By recovering DNAPLs from spent GAC, the site prevented cross-media transfer of these pollutants from treatment residuals.

11.5.3 Views and Discussion

Because of the confinement of contaminated soil, and due to the fact that SVE created a negative pressure under the main slab of the building, there was very little potential for release of VOCs inside the building. Workspace air monitoring was, however, conducted to confirm that the SVE system was operating properly at all times. The confinement of soil under the building also prevented the leaching of contaminants to groundwater or surface waters, making it unnecessary to monitor these media during the operation of SVE at this site.

11.6 Excavation and Thermal Treatment of VOC-Contaminated Soil and Debris at a DOE Site in Colorado (Site 6)

11.6.1 Description of Site Remediation Activities

During 1996, two trenches were excavated at this site to remove approximately 2,200 cubic yards of VOC-contaminated soil and debris which were believed to be contributing to groundwater degradation in the area. The excavated materials were treated on site by low temperature thermal desorption. The soils were also known to be contaminated by low level radioactive materials. On the basis of site data obtained before commencing site remediation, the depth of trenches was estimated to be nearly 10 feet. The trenches were excavated until VOC concentrations in soils were below cleanup standards or the excavation encountered bedrock or groundwater. The contaminated materials -- soil and debris -- were treated for removal of VOCs in a set of six thermal desorption units (TDUs). Each TDU consisted of a low-temperature, low-vacuum extraction chamber and an infrared heat source. The average treatment rate for the set of TDUs was 100 cubic yards per day. The maximum size of the soil/debris feedstock allowable to the TDU was eight inches. After completing treatment and verifying the achievement of cleanup standards, the treated soil was placed back in the trenches, compacted and covered by clean top soil.

11.6.2 BMPs Used to Prevent Cross-Media Transfer of Pollutants

There was a potential for release of off gases at soil-vapor extraction (SVE) wells which had been used in the past for soils treatment at this site. There was also a potential for mixing soils with different levels of radioactivity during the treatment of soils for VOCs. It was also necessary to minimize radiation hazards at this site. Other concerns for cross-media transfer of pollutants to be addressed during this site remediation included: contamination of clean top soil during excavation of contaminated subsurface soil in the trenches; air emission of dust from contaminated soil feed stockpiles (CSFSs) and treated soil stockpiles (TSSs) maintained on site during site remediation; and contamination of stormwater run-on and run-off by contacting the materials in CSFSs and contaminated debris stockpiles. A list of 12 BMPs used to address these concerns is given below.

Site Preparation and Staging

- a. Proper demobilization of SVE wells and equipment.
- b. Performing a survey to detect low energy radiation.
- c. Establishing site control zones.
- d. Preparing debris and CSF stockpile areas.
- e. Perimeter air quality monitoring.

Pre-Treatment

- f. Stripping the uncontaminated top soil at each trench.
- g. Segregating CSFSs based on radiological measurements.
- h. Providing a Jersey barrier with trench around each CSFS.
- i. Arranging for use of special dust suppressants on TSSs.
- j. Evaluating debris samples for need of treatment.

Soil Treatment

- k. Using decontamination wastewater for dust control on CSFSs.

Post-Treatment

- l. Backfilling and revegetation of the site.

Additional details on the field application of each of these BMPs are given below.

a. Proper Demobilization of SVE Wells and Equipment. The site preparation required properly abandoning five vadose zone SVE wells adjacent to one of the trenches and drilling out the inner grout from the conductor casing of four previously abandoned SVE bedrock wells. All unnecessary equipment was removed from the area. By completing these tasks, the site prevented an unplanned release of soil vapor in the area and other problems in excavating the trenches.

b. Performing a Survey to Detect Low Energy Radiation. A pre-work survey of low energy radiation in the area was conducted during site preparation. For this survey, the entire area was divided into 50-foot grids. The survey also measured radiation in 2-3 foot grids for areas (e.g., traffic zone) in contact with radiologically contaminated

soil. Radiological monitoring was also conducted during excavation of trenches. This enabled the facility to define the initial levels of radiological contamination of soil.

c. Establishing Site Control Zones. During site preparation, the trench boundaries were staked and trench reference points were located. Access to the site was restricted to six feet from the edges of the trench boundaries. A layout was also prepared of the exclusion zone, contamination reduction zone and project support zone during site remediation. Decontamination procedures were also developed for personnel and equipment.

d. Preparing Debris and CSF Stockpile Areas. The facility prepared areas for debris and contaminated soil stockpiles, as necessary, to minimize the quantities of materials to be treated on site. For example, only the debris contaminated with VOCs, or debris that could not be tested for VOCs, were processed in the TDU. Debris free of VOCs were stockpiled in a different area. The upper 4 to 6 inches of uncontaminated topsoil from the CSF and debris stockpile areas were also removed during site preparation and stored for later use.

e. Perimeter Air Quality Monitoring. Four high-volume air sampling stations were set up in the perimeter (one upwind and three downwind) of the source removal area. In addition, the air monitoring of VOCs was conducted by using FID/PID during soil excavation.

f. Stripping the Uncontaminated Top Soil at Each Trench. The upper two feet of uncontaminated top soil was stripped from each trench and stored near trench boundaries. This enabled reuse of the top soil after treatment of contaminated soil and backfilling of trenches with treated soil. Before excavating each trench, groundwater levels in the area were monitored to establish the depth to prevent additional contamination and excavation of soil.

g. Segregating CSFSs Based on Radiological Measurements. The soil exhibiting low energy radiation greater than 3 times the background radiological measurements was separated from other CSF stockpiles. This practice enabled the site to achieve the "put back" levels of radiation after completing soil treatment and backfilling the trenches with treated soil.

h. Providing a Jersey Barrier with Trench Around Each CSFS. The CSF stockpiles had dimensions of approximately 40 feet by 40 feet established by Jersey barriers on three sides to contain the contaminated soil. (A Jersey barrier is a portable concrete barrier, generally used in highway construction for the purpose of dividing or demarcating lanes. These barriers were provided to this facility at no cost, making this BMP very cost-effective.) This feature minimized the commingling of stormwater run-on with the CSFSs and minimize wind blown dispersion of soil. A custom fit, water resistant tarpaulin, stretched across the Jersey barriers minimized accumulation of stormwater and further minimized wind blown dispersion of soil. Care was taken to avoid contact between the top side of the tarp and the contaminated soil within the CSFS. A plastic-lined, gravel-filled trench surrounded the Jersey barriers to collect stormwater run-off from the CSFS.

i. Arranging for Use of Special Dust Suppressants on TSSs. A special agent (fibrous slurry) was used for dust control on treated soil stockpiles to minimize the use of water. This agent is prepared by mixing two products with water just before use. The first product includes binding material blended with natural earthen materials, biodegradable organic compounds with other inert materials and natural cellulosic materials. The second product is recycled cellulose. The mixture is a thick, viscous slurry that will cling to vertical surfaces on application. Depending on the weather conditions, this dust suppressant was found to be effective for several weeks after each application.

j. Evaluating Debris Samples for Need of Treatment. The waste streams generated during site remediation included debris from the trenches. Following evaluation of debris samples, the debris was either processed in TDUs or sent for disposal off site. This procedure minimized the need to treat debris on site, while preventing any contamination due to poor waste management.

k. Using Decontamination Wastewater for Dust Control on CSFSs. Wastewater generated at the site from personnel and equipment decontamination activities was used to suppress dust from the CSFSs and/or the trenches being excavated. The use of decontamination water for dust control reduced the amount of clean water required for dust suppression on site and ultimately reduced the volume of wastewater generated during site remediation. Stormwater run-off collected in the trenches surrounding CSFSs was also used for dust control.

l. Backfilling and Revegetation of the Site. Site reclamation consisted of three tasks: backfilling of treated material into trenches, demobilization of all equipment and re-vegetation of the project support zone. Because the CSFSs were segregated based on radiological measurements, it was possible to achieve the initial levels of radiation when treated soils were put back into the trenches. The uncontaminated top soil stripped from each trench during soil excavation was also used with treated soil in backfilling operations.

11.6.3 Views and Discussion

In addition to the BMPs listed above, the site ensured that aqueous and organic phase condensates recovered from the TDUs were treated and/or disposed of to minimize any additional contamination due to improper waste management. Typically, the aqueous phase condensates were treated on site and the organic phase condensates were containerized and disposed off site. With reference to the BMP listed under 11.6.2(g), it would be advisable to determine leachability of radioactive contaminants to groundwater before backfilling treated soil.

11.7 On-Site Containment of Soils in Former Manufacturing Areas at a Chromium Plant, Maryland (Site 7)

11.7.1 Description of Site Remediation Activities

In 1991, a Corrective Measures Implementation Program Plan (CMIPP) was submitted by the owner of a 140-years old chromium ore processing facility in Maryland to prevent

further migration of contaminants to the soil, groundwater and surface water. The owner of the facility had stopped manufacturing operations in 1985 and entered into a Consent Decree with EPA and Maryland Department of the Environment (MDE) in 1989 to investigate the nature and extent of contamination at the 20-acre facility and submit the CMIPP based on the findings of their investigations. These investigations found that the soils were contaminated with hexavalent chromium (above the action level of 10 parts per million) in a few areas of the site where the maximum concentration of chromium was found to be 94 mg/kg. Higher levels of contamination were also found in the sediments in the harbor surrounding the peninsular facility. Both the shallow aquifer (0-20 feet below the ground surface) and deep aquifer (23-70 feet below the ground surface) were found to be contaminated with chromium, with the highest concentrations (14,500 mg/l for the shallow aquifer and 8,000 mg/l for the deep aquifer) found near the former manufacturing area at the facility. Chromium in the deep aquifer had migrated approximately 2,750 feet off-site along the top of the bedrock where the concentration of chromium was 1,600 mg/l. However, no user of the deep aquifer for drinking water could be identified. The surface water in the marine harbor surrounding the facility was found to be contaminated with chromium at the maximum concentration of 3,170 ppb (above the standards of 50 ppb for chromium in marine waters).

The proposed corrective measures included: the installation of a deep vertical hydraulic barrier (slurry wall) as a containment structure to prevent the release of contamination into the marine harbor and groundwater surrounding the facility; installation and operation of a groundwater withdrawal system within the containment structure to maintain an inward hydraulic gradient of groundwater at the site; construction of a multi-media cap over the containment area to prevent any future exposure to the contaminated soil and control the generation of contaminated leachate from any infiltration of precipitation at the site; and a comprehensive surface and groundwater monitoring system to confirm that all the site remediation goals are being achieved. In preparation for implementing these corrective measures, the facility owner dismantled the manufacturing plant existing at the facility (including 21 buildings, 240,000 square feet of transite roofing, 15,000 tons of decontaminated equipment and structurals and 50,000 tons of concrete and rubble to be sampled, classified and shipped to appropriate facilities off-site). Prior to the construction of containment structures, approximately 150,000 cubic yards of sediments were dredged from the harbor surrounding the facility, a new outward embankment was constructed, and soil found on site contaminated with chromium or other hazardous contaminants above the action levels was excavated and disposed off-site.

The implementation of the CMIPP commenced in 1993 after completely dismantling the plant and providing an asphalt cover over the former manufacturing areas at the site. The deep vertical hydraulic barrier is now provided by a slurry wall mixture of soil and bentonite encompassing 15 acres of the site. This slurry wall was trenched over a linear distance of 3,300 feet by 3 feet wide with a depth ranging from 65 to 80 feet up to the bedrock. A multi-media cap of geosynthetic clay liner and 60 mil LDPE geomembrane covers is now being provided over the area within the slurry wall. A system for pumping, treating and disposing of the groundwater from the site is now operational. This system will continue to operate in order to maintain an inward hydraulic gradient of 0.01 foot per foot from outside to inside the slurry wall. After completing the construction of a multi-media cap, the concentration of chromium in the surface water outside the facility

will be maintained within regulatory levels by monitoring the performance of the slurry wall and by controlling the rate of groundwater extraction from the site. This site remediation is also designed to permit future development of the site as a mixed-use (recreational and commercial uses) zone.

11.7.2 BMPs Used to Prevent Cross-Media Transfer of Pollutants

The RCRA corrective action nearing completion at this site is designed primarily to minimize the future releases of contaminants from the soils to the air, surface water and groundwater. In addition, the site remediation activities were conducted in a manner to prevent any significant cross-media transfer of pollutants during site preparation and installation of containment structures at the site. The containment structures were also designed to minimize the possibility of improper operation during the future development and use of site for recreational or commercial purposes. A list of 11 BMPs used at the site to address cross-media transfer of pollutants is given below.

Site Preparation and Staging

- a. Perimeter and personnel monitoring of air quality.

Pre-Treatment

- b. Monitoring trends in air quality and weather conditions to control construction activities on site.
- c. Covering debris generated during construction.
- d. Providing temporary sumps for collecting stormwater run-off from the site during construction.
- e. Preventing surface water pollution during construction of the slurry wall.
- f. Providing temporary arrangements for trucks crossing over the slurry walls during the remaining construction.

Soil Treatment

- g. Checking the integrity of slurry wall.
- h. Providing standby well-heads for additional future groundwater extraction on site.
- i. Providing a capillary break layer in multi-media cap.
- j. Preparing multi-media cap for future site development.

Post-Treatment

- k. Environmental monitoring plan for checking effectiveness of site containment.

Additional details on the field application of each of these BMPs are given below.

- a. Perimeter and Personnel Monitoring of Air Quality. Before implementing the CMIPP, the existing buildings, equipment and structures at the facility were dismantled under a plan approved by the MDE and incorporated into the Consent Decree. This plan

required the perimeter monitoring of air quality for possible release of chromium and asbestos during dismantling operations. The facility installed six air sampling stations in the perimeter of the site which operated continuously for 24 hours to filter the ambient air and provide samples for analysis of the concentrations of chromium and asbestos. The air quality was then compared with the standards for average and maximum concentrations of each pollutant. The concentration of a pollutant as measured by any of the six air sampling stations was also normally expected to be within twice the standard deviation of the recent values as measured by all six stations. Otherwise, it was assumed that an exceedance of air quality had occurred and that a corrective action was required. In addition to monitoring air quality in the perimeter of the site, the site used personnel monitoring for chromium and asbestos to assure the health and safety of personnel working on site during the dismantling and disposal of the plant.

b. Monitoring Trends in Air Quality and Weather Conditions to Control Construction Activities on Site. The site monitors any trends in the concentration of chromium in ambient air on a daily basis. These trends are examined rather than waiting for an exceedance of air quality standards taking place on site. These trends are discussed at daily meetings and a possible list of reasons is prepared for any trends observed. These trends are also compared with the related set of weather conditions as measured by a weather station installed on site (e.g., wind speed and direction are compared with trends in the concentration of chromium). In a specific case of air quality monitoring at this site, it was found that high concentrations of chromium were probably related to a spell of dry and windy weather. In response, new efforts were made to suppress dust emission by spraying water on the stockpiles and other areas of construction on site. Work has also been stopped on several occasions when air quality standards were exceeded.

c. Covering Debris Generated During Construction. A site visit during the regrading of the site prior to the placement of a multi-media cap showed that the piles of debris generated during previous construction activities were kept covered under sheets of plastic. This practice was followed in the site mainly due to concerns of wind carrying over any dust or other debris from open piles to the harbor nearby which is commonly used for recreation.

d. Providing Temporary Sumps for Collecting Stormwater Run-Off From the Site During Construction. During the same visit, it was found that temporary sumps were provided with a pumping system to collect and transfer any run-off from the site to the tanks being used for storing groundwater extracted on-site. This arrangement prevented a transfer of site pollutants to the surface water during construction. After construction of the cap, a permanent system will be made available for diverting stormwater run-on to the site and collecting stormwater run-off from the site.

e. Preventing Surface Water Pollution During Construction of the Slurry Wall. In addition to the detailed specifications and inspections required to assure a high quality construction of the slurry wall and trench at this site, a few precautions were taken to prevent cross-media transfer of pollutants during construction. For example, the trench construction spoils were placed at levels above the 100-year level of high tide, and were also covered by a sheet of plastic. These spoils were tested for the presence of high concentrations of chromium and were provided with an appropriate management of

stormwater run-on/run-off. Fugitive dust emission from the spoils was controlled during periods of dry weather by sprinkling water over the spoils.

f. Providing Temporary Arrangements for Trucks Crossing Over the Slurry Walls During the Remaining Construction. During construction of the multi-media cap over the site, a short bridge of concrete is provided over the slurry wall at several points to permit the occasional travel of trucks. This arrangement prevents damage to the slurry wall affecting its containment performance.

g. Checking the Integrity of Slurry Wall. The containment performance of the slurry wall was assessed after its construction (but prior to final remedial construction on site) using a series of hydraulic tests and monitoring. For the purpose of testing, paired piezometers were designed to the same specification as the final groundwater extraction wells. Water levels in the shallow aquifer outside the slurry wall rose at an average rate of 0.35 foot of head per month during and immediately after slurry wall construction. Individual pumping tests were performed in the deep aquifer and at four locations inside the site perimeter. In these locations, even with 25 feet of drawdown, the outside piezometers did not indicate the influence from the pumping well. Thus, barrier integrity in the vicinity of the pumping and monitoring was confirmed. Several interior piezometers were then pumped simultaneously to simulate the groundwater withdrawal after remedial construction on site. Tests confirming earlier pumping test results showed rapid drawdown propagation in the confined aquifer within the slurry wall. As a visual indicator of any settlement of slurry wall contents occurring after construction, a steel plate was embedded in the slurry wall at several locations and used as a level gage for direct measurement of subsidence.

h. Providing Standby Well-Heads for Additional Future Groundwater Extraction on Site. In anticipation of future problems in operating the groundwater pumping system at the locations specified now, the site had provided standby well-heads (without pumps) which could be used as a contingency. This feature minimizes the need to damage the multi-media cap and drill new wells for an upgrade of the groundwater extraction system after site development.

i. Providing a Capillary Break Layer in Multi-Media Cap. The site uses a capillary break layer to prevent any capillary rise of contaminated water from the site to the low-permeability layer (containing geosynthetic clay liner and geomembrane) above. Upward migration of contaminants is thus prevented.

j. Preparing Multi-Media Cap for Future Site Development. As the site is permitted for development as a multi-use zone, concept designs were prepared for the cap in areas to be paved or unpaved in future. A multi-media cap with grass surface cover, for example, will have a brightly colored (orange) geotextile placed 18 inches beneath the surface to alert future developers of the site that a penetration of the cap below this point might result in infiltration of water to contaminated soils below the cap.

k. Environmental Monitoring Plan for Checking Effectiveness of Site Containment. Monitoring of chromium in surface water and groundwater levels both inside and outside the slurry wall will be continued on a regular basis after completing the installation of multi-media cap and groundwater drainage wells. It is expected that the standards of 50

ppb for chromium in surface water and the maintenance of required gradient in ground water will be achieved in future by pumping and treating groundwater at the rate of only about 2,000 gallons per day (gpd). In contrast with this rate of groundwater withdrawal, the temporary arrangements on site now are pumping about 60,000 gpd.

11.7.3 Views and Discussion

While preparing this site for containment, it was necessary to take up other large tasks which were, by themselves, major remedial actions and included the use of additional BMPs to prevent cross-media transfer of pollutants. These tasks included: (i) dredging of contaminated sediments from the harbor and replacing the dredged sediments with clean stone for stabilizing the existing bulkheads around the site; and (ii) dismantling the old chromium plant under negative pressure to prevent the emission of chromium and asbestos into the neighboring areas as fugitive dust.

Because of the contaminant levels encountered, the dredging and disposal of the sediments were accomplished under stringent environmental controls. To ensure that sediments with excessive heavy metal concentrations were not taken to the disposal facility off-site, testing and bulking of every load of dredged spoils was required. Dredging was also performed completely within a turbidity curtain. Water sampling and analysis for chromium was conducted inside and outside the curtain to check the curtain's effectiveness in reducing migration of chromium in the surrounding harbor waters. In one area of the site where confined space would have made dredging very problematic, the sediments were stabilized and capped in place subsequent to construction of the rock embankment at this location.

Prior to constructing the slurry wall, a new rock embankment was constructed to prevent any unexpected collapse of contaminated soils into the harbor during construction of a trench for the slurry wall. This embankment was located outside the existing bulkheads along the boundary of the site with the marine harbor. The new outboard embankment also enabled containment of the contaminated surfaces of the bulkheads within the slurry wall.

The dismantling of the plant was conducted with a series of controls designed to assure worker health and safety during these operations. The buildings at the site were categorized according to pollutant concerns (i.e., only asbestos, asbestos and chromium, and only chromium) and the dismantling plan required development and fabrication of enclosures for creating a negative pressure during the dismantlement of some buildings. One of the buildings, for example, used nine HEPA filters with a capacity of 18,000 cfm each, as well as the use of water curtains and air seals during dismantling operations. This plant building was 300 feet long and 70 feet wide with a maximum height of the roof of 100 feet. There was another large building with similar dimensions and several smaller buildings that were dismantled under negative air pressure.

11.8 Ex Situ Bioremediation of Explosives Contaminated Soils at a DoD Facility in Virginia (Site 8)

11.8.1 Description of Site Remediation Activities

In 1996, a Superfund Removal Action involving the excavation and transportation of 800 cubic yards of explosives-contaminated soil was completed within three days at one of several sites within a DoD facility being investigated under an Installation Restoration Program (IRP). At this site, the contaminated soils were found in a drainage area located near wetlands and along a small tributary within the Chesapeake Bay watershed. The site had received nitramine-containing wastewater from a weapons manufacturing plant since 1945. Although this effluent was diverted in 1986 to a sanitary sewer and the site had reverted to a natural drainage area, explosive compounds such as TNT, HMX and RDX were found at elevated concentrations in the samples of soil and sediments obtained recently from the area. A decision was made to excavate soils up to 4 feet depth from the drainage area which was partly subject to tidal action every day. Parts of the drainage area was on a wooded slope of about 15 degrees leading to the wetlands.

After clearing the wood and preparing the site for excavation, two excavators were operated round-the-clock to remove and load contaminated soil to dump trucks parked on the road, about 20 feet above the bottom of the drainage area. The excavated soil was transported over a distance of less than 1 mile to another location where a suitable biocell had been constructed earlier to conduct a pilot study of an anaerobic process for treating explosives in the soil. Approximately 600 cubic yards of the explosives-contaminated soil was screened and then slurried before it was pumped into the biocell for treatment. Proper operating conditions were maintained in this biocell and the treatment goals for removal of explosive compounds from the soil and supernatant were achieved, as planned, in nearly 60 days of bioremediation. The treated biocell contents will be left in place and the cell will be closed with topsoil and vegetation after allowing excess water to evaporate. Approximately 200 cubic yards of untreated soil removed from the contaminated site and over 1,000 cubic yards of soil excavated to construct the biocell remain for disposal in the pilot study area.

As the results of the pilot study were positive and treatment goals seem to have been achieved, scaled-up operations using the anaerobic bioremediation process may be applied to treat explosives contaminated soils found at other sites within the facility.

11.8.2 BMPs Used to Prevent Cross-Media Transfer of Pollutants

The pilot study of soil bioremediation and removal action completed recently at this site used BMPs to prevent a few concerns for cross-media transfer of pollutants, like surface water pollution due to stormwater run-off/run-on. However, there are other concerns which would have to be addressed by BMPs in full-scale operations at this site. A list of five BMPs used at this site to prevent cross-media transfer of contaminants is given below:

Pre-Treatment

- a. Arranging for containment of soils during excavation.
- b. Controlling the transportation of excavated soils.
- c. Providing for stormwater run-on/run-off controls near biocell.
- d. Using soil erosion and sedimentation controls near biocell.
- e. Containing spills during pre-treatment operations.

Additional details on the field application of each of these BMPs are given below.

a. Arranging for Containment of Soils During Excavation. During site preparation, a silt fence and straw bales were installed downslope of the excavated area along the border of the site with the wetlands nearby. These soil erosion and sedimentation controls prevented, to some extent, the carry-over of contaminated soils and sediments by daily tidal action on the site. The rapid completion of soil removal within three days also contributed towards a better containment of pollutants at the site.

b. Controlling the Transportation of Excavated Soils. The dump trucks used for transporting excavated soil from the site being remediated to the biocell were loaded by excavators outside the site. A fixed route was always used for transportation to limit the areas outside the site from being contaminated by spills on the road. Roll-off containers were used instead of dump trucks to transport wet soils excavated from the site.

c. Providing for Stormwater Run-On/Run-Off Control Near Biocell. The biocell area was on a plateau and existing run-on was diverted around the area via a drainage swale and an existing culvert. In addition, the biocell was given adequate (18 to 24 inches) freeboard to accept direct precipitation and any stormwater run-on during normal operations. At the same time, two portable tanks were kept ready on site to pump out additional water draining into the biocell during storms.

d. Using Soil Erosion and Sedimentation Controls Near Biocell. Stormwater runoff from the biocell was designed to pass through soil erosion and sedimentation controls. A silt fence and strawbale checkdams were therefore installed on the downslope of the area used for the biocell. These controls were placed before starting the construction of the biocell. The area was then graded to ensure that all stormwater runoff passes through the controls, which will remain until the site is vegetated after completing all operations. Any vehicular traffic in the site is now limited to the haul roads leading to the biocell.

e. Containing Spills During Pre-Treatment Operations. Any leaks or spills of contaminated water during the screening and slurring of contaminated soils was automatically drained by gradient into the biocell. This prevented the contamination of soils outside the biocell.

11.8.3 Views and Discussion

A full-scale site remediation based on this pilot study should consider the use of additional BMPs during site preparation and staging, pre-treatment and soil treatment. The site had already planned a facility-wide groundwater monitoring and treatment in lieu of the post-treatment phase of all site cleanup efforts. Additional BMPs that could be used in full-scale operations include the following:

- ✓ An assessment of the potential impact on the ecology of neighboring areas should be performed before conducting excavation for ex situ remediation of other contaminated sites that are located near wetlands. The feasibility of in situ bioremediation should be considered as an alternative to prevent

cross-media transfer of pollutants during excavation and transportation, as well as the potential for contaminating the new site selected for operating the biocell.

- ✓ The site should be well-protected from flooding during storms.
- ✓ A storage area (with liners, berms and top cover) should be provided for excavated soils to prevent leaching of contaminants from the soils awaiting treatment.
- ✓ Future efforts using ex situ bioremediation should provide excess capacity for treatment to prevent stockpiling of untreated soil on site at the end of operations. Marshy conditions usually make it necessary to excavate more quantities of soil than planned and the excavated soil may contain large quantities of fine tree roots which cannot be removed easily from soil before treatment.
- ✓ Surface water run-off should be monitored during excavation in marshy land subject to daily tidal action.
- ✓ The air emission of organics (e.g., methane) should be monitored during treatment in the biocell. A log should be maintained to record air monitoring data with details of wind direction on a daily basis during full-scale operations.
- ✓ The use of a dragline instead of excavators should be considered as an alternative equipment in marshy lands to avoid the problems of getting stuck in marshy areas (as experienced at this site).
- ✓ Biocells used in large operations should be equipped with concrete floors with protective lining systems, such as studded liners, instead of the flexible double liners separated by sand as used in the pilot.
- ✓ The pipes used for recirculating process water in the biocell should be run within the unit to prevent contamination of outside soil from leaks in these pipes.

11.9 Comparison of Selected Case Study BMPs With BMPs Recommended in this Guidance

EPA found that some BMPs were used to address concerns of cross-media transfer in different remedial phases. In a few case studies, EPA found that additional BMPs could have been used; these additional BMPs have been identified under views and discussion pertaining to each specific case study in this chapter.

The case studies performed by EPA also indicated that most BMPs are introduced in the earlier two phases of site remediation, or during site preparation/staging and pretreatment of soil. The most common type of activity describing a BMP used in the first phase of site preparation/staging appears to be the installation of a suitable environmental monitoring system before the commencement of any remediation work at the

site. In most cases, this type of BMP may only involve the installation of an air quality monitoring station at the perimeter of the site to address concerns of air pollution in the neighboring community due to site remediation in future. In some cases, however, the perimeter air quality monitoring may be supplemented by area and/or personal monitoring at the location of soil excavation and treatment. Air quality monitoring may also be supported by a monitoring of changes in weather conditions, as shown by one of the cases studied by EPA. At this same site, EPA found that both surface water quality and air quality were being monitored due to the concerns of transfer of pollutants in both media during site preparation and pretreatment of soil.

In addition to the use of environmental monitoring as a BMP, EPA found that site preparation often included the construction of new facilities like soil treatment pads (or improvement of existing facilities) that have proved to be effective BMPs. At least two sites were found to have used additional site characterization as a BMP during site preparation/staging. For example, Site No. 1 (Army Ammunition Plant, Minnesota) delineated the actual limits of soil contaminated with lead and other metals before starting any excavation at the site. At the same site, more additional studies were conducted to identify and characterize miscellaneous disposal areas existing at the site to enable a segregation of the materials found in these areas from the metals contaminated soil. This in-depth characterization of the site reduced the quantity of soil requiring treatment and possibly improved the performance of soil treatment as well. This site also found the establishment of an exclusion zone and decontamination pad for all traffic to/from the site to be effective measures in preventing the cross-media transfer of pollutants during soil excavation.

EPA found that the field use of BMPs is also widely introduced during the pre-treatment phase of site remediation. Most sites were found to have arranged for dust suppression and stormwater run-on/run-off control during site remediation. Different methods of suppressing dust are used during soil excavation and transportation, storage of excavated soil and treated soil in stockpiles, and soil treatment. At some sites groundwater protection measures (e.g., providing lined and cover roll-offs for soil treatment residuals) were also introduced as BMPs to prevent cross-media transfer in the pre-treatment phase of site remediation. BMPs in the pretreatment phase of site remediation also included the use of special measures, like selecting the right equipment for excavating soils and providing temporary arrangements for trucks to move in the site during construction, to prevent the generation of additional wastes or other transfer of pollutants.

The case studies performed by EPA did not identify as many BMPs as originally expected during the treatment phase of site remediation. This observation may be due to the fact that records used in the case studies focussed more on the site specific details (in contrast with design features of the technologies selected for soil treatment at the sites). Most of the BMPs used during soil treatment, as identified by the case studies, were related with proper management of wastewater and other process intermediates. Site No. 7 (Chromium Manufacturing Plant, Maryland), however, made at least three (3) important changes in its technology for soil containment: (i) providing a capillary break layer in the multi-media cap; (ii) preparing multi-media cap for future development of the site as a commercial and recreational area; and (iii) providing standby well-heads

for additional future groundwater extraction at the site. This site also conducted a series of tests to check the integrity of slurry wall after construction.

The BMPs identified by the case studies included a few that were introduced in the post-treatment/residuals management phase of site remediation. Most of these BMPs involved proper disposal of treatment residuals, including the sorting, decontamination and pretreatment of residuals to enable off-site disposal of residuals as non-hazardous waste. A proper restoration of the site was also used in some cases as a BMP. Environmental monitoring, especially the monitoring of groundwater, after completing soil treatment at the site was also considered to be a BMP.

Table 11-2 provides examples of field/case study findings and relevant modifications to the BMP guidance document. As indicated in this table, findings from the case studies were sometimes used to add new BMPs to previous chapters of this guidance document.

Table 11-2. Examples of Field/Case Study Findings and Relevant Modifications of the BMP Guidance Document

Field/Case Study Observations	BMPs or Other Reference in Guidance Document	Comments/Modifications of the BMP Document
Soil Washing (Site 1): Delineating the actual limits of soil contamination (See Section 11.1.2.a); and Conducting an in-depth characterization of new disposal areas located on site (See Section 11.1.2d)	There is a risk of inaccurate characterization with any soil treatment technology (Chapter 2); and Accurate characterization (e.g., ...quantities of soil..) is important for the efficient use of [soil washing] technology (Chapter 5)	Guidance Document recognized the concern of cross-media transfer, but BMPs should be developed to match site-specific conditions
Soil Washing (Site 1): Building an earthen berm for controlling surface water run-on to and run-off from the site (See Section 11.1.2g)	Any off-site runoff should generally be prevented from ...mixing with site contaminated media by building earthen berms (Chapter 5)	Case Study provides typical dimensions of an earthen berm
In Situ Stabilization (Site 2): Conducting additional soil tests to determine the effectiveness of soil stabilization (See Section 11.2.2d)	Treated wastes should be checked for leachability prior to disposal (on site) (Chapter 2)	Guidance Document revised (Chapter 2) to include new BMP with a reference to in situ soil treatment technologies
Ex Situ Stabilization (Site 3): Modifying the process for treatment of soil from different areas of the site (See Section 11.3.2e)	Wastes should be homogenized as much as practical before processing (ex situ) (Section 10.4)	Guidance Document revised (Chapter 10) to modify recommended BMP with a reference to ex situ S/S technologies
Soil Washing (Site 4): Monitoring of air quality during operations at AECs and the CAMU pad (See Section 11.4.2a)	... organic or inorganic (air) emissions should be monitored and appropriate emission control measures should be used ... (Chapter 5)	Guidance Document was confirmed by the field application of air monitoring and emission control systems; use of hood or cover to capture air emissions is not always needed
SVE (Site 5): Containerization of drill cuttings (See Section 11.5.2a)	...waste resulting from excavation and installation of wells should be properly treated on site or trucked away for disposal (Chapter 2)	Guidance Document was confirmed by the field practice of containerizing drill cuttings during remedial activities
Thermal Treatment (Site 6): Arranging for use of special dust suppressants on treated soil stockpiles (See Section 11.6.2i)	Fugitive dust emissions should be controlled during excavation by spraying water to keep the ground moist	Guidance Document revised (Chapter 2) to include the use of special dust suppressants (e.g., fibrous slurry or pine sap)
Containment (Site 7): Monitoring trends in air quality and weather conditions to control construction activities on site (See Section 11.7.2b)	Real-time weather data could be used to monitor weather conditions and accordingly control treatment operations (Chapter 2)	Guidance Document was confirmed by field practice of using weather monitoring station; recommended BMP was modified to include a reference to "trends" in air quality and weather conditions (Chapter 1)
Containment (Site 7): Providing a capillary break layer in multi-media cap (See Section 11.7.2i)	Geomembranes and drainage layers in multi-media caps should be protected from capillary rising of contaminants from the waste materials being contained (Chapter 4)	Guidance Document was revised (Chapter 4) to reflect the field practice observed in this case study
Bioremediation (Site 8): Problems due to lack of adequate treatment capacity (See Section 11.8.3)	Biotreatment systems should be designed to meet unexpected changes in soil characteristics and/or quantities (Chapter 8)	Guidance Document was revised (Chapters 2 and 8) to address the problem identified in the field