



Evaluation of Diffusion Denuder Coatings for Removing Acid Gases from Ambient Air

EPA-454/R-02-011
April 2002

Evaluation of Diffusion Denuder Coatings for Removing Acid Gases from Ambient Air

By:
Dennis R. Fitz
College of Engineering-Center for Environmental Research and Technology
University of California
Riverside, CA 92521

Prepared For:
Office of Air Quality Planning & Standards
Emissions, Monitoring, and Analysis Division

Assistance Agreement #GX828663

U.S. Environmental Protection Agency
Office of Air Quality Planning and Standards
Emissions, Monitoring, and Analysis Division
Research Triangle Park, NC 27711

Acknowledgments

The author would like to thank John Pisano, who did a marvelous job of constructing the test apparatus, supervising the experiments and organizing the data. Irina Malkina operated the test system, and her dedication resulted in nearly 100% data capture with all runs being completed within a tight schedule.

Table of Contents

Acknowledgments.....	i
1. Introduction.....	1
1.1 Background	1
1.2 Approach	1
2. Experimental.....	2
2.1 Coated Filters and Denuders	2
2.2 Test Gas Generation, Measurement and Data Recording	3
2.3 Experimental Matrix	8
3. Results and Discussion.....	10
3.1 Removal Efficiency	10
3.2 MgO-Coated Annual Denuder	10
3.3 Sodium Carbonate-Coated Annular Denuder.....	12
3.4 Sodium Chloride-Coated Annular Denuder	15
3.5 Magnesium Oxide-Coated Honeycomb Denuder	16
3.6 Sodium Carbonate-Coated Honeycomb Denuder	18
3.7 Sodium Chloride Denuders	19
3.8 Filter Testing	20
3.9 Additional QC Tests to Evaluate the NO _y Analyzer Memory Effect	25
4. Summary and Conclusions.....	28
5. Recommendations and Future Research	29
5.1 Recommendations	29
5.2 Future Research.....	30
References	32

Tables

Table 1.	Test matrix for denuder evaluation	9
Table 2.	Matrix of tests for evaluation	9
Table 3.	Summary of removal efficiency for denuders	11
Table 4.	Summary of filter data.....	22
Table 5.	Data showing the first ten minutes after injection of zero air	27
Table 6.	Summary of removal efficiencies.....	28

Figures

Figure 1.	Schematic diagram of the apparatus to expose denuders and filters	3
Figure 2.	Photograph of the test apparatus	4
Figure 3.	Plot of the pH titration curve for diffusion tube B	5
Figure 4.	Plot of the TDL NO ₂ and HNO ₃ concentrations when sampling from diffusion tube B	6
Figure 5.	Plot of the pH titration curve for diffusion tube A	7
Figure 6.	Summary of removal efficiency tests for MgO-coated annular denuders	11
Figure 7.	Summary of removal efficiency tests for sodium carbonate coated annular denuders.....	13
Figure 8.	Time series plot of HNO ₃ collection efficiencies, low humidity	13
Figure 9.	Time series plot of HNO ₃ removal efficiencies, high humidity.....	14
Figure 10.	Time series plot of HONO removal efficiencies and concentrations, low humidity	15
Figure 11.	Summary of removal efficiency tests for sodium chloride- coated annular denuders	16
Figure 12.	Summary of removal efficiency tests for the magnesium oxide- coated honeycomb denuders.....	17
Figure 13.	Time series plot of HONO removal efficiencies, high concentrations, high humidity	17
Figure 14.	Summary of removal efficiency tests for the sodium carbonate- coated honeycomb denuders.....	18
Figure 15.	Time series plot of HONO removal efficiencies and concentrations, high concentration, low humidity.....	19
Figure 16.	Removal efficiency of sodium chloride-coated annual and honeycomb denuders for 10 ppb of nitric acid at 30% RH.....	20
Figure 17.	Summary of removal efficiency tests of the replicate nylon filters for removing NO ₂ , HONO, and PAN.....	21
Figure 18.	Summary of removal efficiency tests of the NaCl-coated quartz filters for removing NO ₂ , HONO, and PAN.....	23
Figure 19.	Summary of removal efficiency tests of the replicate Na ₂ (CO ₃)-coated quartz filters for removing NO ₂ , HONO, and PAN	24
Figure 20.	NO _y measurements at the outlet of each denuder with NaCl coated filters added to scrub any remaining nitric acid.	26
Figure 21.	Response of the chemiluminescent NO _y analyzer to a change in concentration from 45 to zero ppb	26

Appendices

Appendix A

Times series plots of concentration and efficiency for all denuders tested

Appendix B

Time series plots of concentration and efficiency for all filters tested.

1. Introduction

1.1 Background

Diffusion denuders have been developed to concurrently remove nitric acid and permit particles to pass unattenuated. The particulate matter may then be collected on specialized filters that minimize further volatilization. This technique allows the measurement of nitric acid and particulate nitrate with a minimum of removal artifacts caused by the volatilization and condensation of ammonium nitrate. There is a significant body of literature describing the suitability of using such denuders and filters for this purpose in studies using ambient air (Allegrini et al., 1994). There is, however, little information on the quantitative testing of these substrates to remove nitric acid while allowing other nitrogenous gases, such as nitrogen dioxide, nitrous acid, and peroxyacetyl nitrate, to pass through freely. Removal inefficiency of the denuder for nitric acid will bias the nitric acid low and the particulate nitrate high, while collecting the other nitrogenous species will bias both high. In addition, there is little published information on the removal efficiency of an aluminum honeycomb denuder that is currently offered as a commercial product.

The primary objectives were to:

- Determine the short-term efficiency and capacity of chemically coated filters and diffusion denuders that are currently used in EPA's National PM_{2.5} Chemical Speciation Network to collect nitric acid and related nitrogenous species under ambient air conditions.
- Assess the potential interferences associated with the collection of gases on reactive filters that follow these denuders that were not efficiently removed by the denuders.

1.2 Approach

The efficiency of magnesium oxide (MgO), sodium chloride (NaCl), and sodium carbonate (Na₂CO₃) coated substrates in collecting nitrogenous species was determined by challenging the substrates to synthetically generated gases. The removal efficiency was determined by measuring concentration before and after the challenged substrate with a chemiluminescent NO_y analyzer. This type of analyzer has been shown to quantitatively measure all species of reactive odd nitrogen containing compounds (Winer et al., 1974). The gases tested included:

- Nitrogen dioxide (NO₂)
- Nitric acid (HNO₃)
- Nitrous acid (HONO)
- Peroxyacetyl nitrate (PAN)

2. Experimental

2.1 Coated Filters and Denuders

Filters and Denuders. Both honeycomb and annular denuders were evaluated. The annular denuders were manufactured by URG (Chapel Hill, NC) and identified as part number URG-2000-242-3CSS. These were 3-channel Teflon-coated stainless steel denuders with a length of 242 mm. Teflon adapters supplied by URG (URG-2000-30AE-7) were used on the inlet and outlet of the denuders to provide a 3/8 inch female pipe fitting. Honeycomb denuders, part number 8382, were manufactured by Met One (Grants Pass, OR) and were supplied in their stainless steel housing (part number 8370).

Five combinations of denuders and coating types were tested for the removal efficiency.

- Honeycomb with a MgO coating.
- Honeycomb with a Na₂CO₃ coating.
- Annular with a MgO coating.
- Annular with a Na₂CO₃ coating.
- Annular with a NaCl coating.

47mm diameter quartz fiber filters (Pallflex QAT) were coated as described below while 47mm diameter Nylasorb nylon filters (Fisher part number 09-751-15) were used as is.

Coating Methods. The honeycomb denuders were coated and extracted according to directions provided by the manufacturer. The denuder was cleaned with methanol and dipped in a slurry of MgO in methanol (50g/160ml). They were then drained and partially dried with dry and filtered compressed air. They were then allowed to dry in a rack overnight and sealed in polyethylene bags until used. A similar technique was used for the carbonate coating except the coating solution consisted of 10g of sodium carbonate dissolved in 1000 ml of deionized water to which 10 g of glycerol had been added.

Annular denuders were coated using a methodology developed by the Research Triangle Institute that is the basis of the recommended procedure by the manufacturer. Approximately 5ml of the MgO slurry described above was added to the denuder with the outlet capped. The other cap was installed and the denuder gently rolled to distribute the coating mixture. The excess mixture was then poured out, and the denuder was subsequently dried using dry, filtered compressed air. The denuders were then capped for storage. The carbonate coating solution was the same as that used for the honeycomb denuder and applied in a similar manner. The NaCl coating solution consisted of 9% (w/w) NaCl dissolved in a 50/50 methanol-water solution (v/v) with 1% (v/v) added glycerol.

Quartz filters were coated by being dipped in the coating solution, allowing the excess to drip out, and then dried on aluminum foil set on the bench top. The coating solution consisted of 2% (w/w) sodium carbonate or sodium chloride in a 50/50 methanol/water solution containing 1% (v/v) glycerol.

2.2 Test Gas Generation, Measurement and Data Recording

Test Gas Exposure System. Figure 1 shows a schematic diagram of the apparatus used to expose the denuders to various test gases. Figure 2 is a photograph of the assembly. Notice that the denuders were positioned to minimize sample line length. The exposed surface of all connecting plumbing was PFA Teflon. The system was designed to simultaneously challenge five denuders. Purified air was humidified by splitting the flow and directing a portion through a bubbler filled with distilled water and maintained at a constant 20°C. After the bubbler, the humidified and dried air streams were remixed. Rotameters and needle valve were used to adjust and monitor the flow to maintain the desired humidity and total flow rate. A General Eastern model Hygro MI chilled mirror sensor was used to measure the dew point. Temperature of the laboratory was monitored with a thermocouple. The relative humidity (RH) of the test gas was calculated from the dew point and the laboratory temperature. Flow through all denuders was set and maintained by needle valves and rotameters. A ThermoEnvironmental model 42C chemiluminescent NO_x analyzer was used to monitor the test gas concentration. A zero, span, and converter efficiency check was performed on the instrument before and after each experiment using a ThermoEnvironmental model 46 dilution calibrator. The calibrator was supplied with ultra zero grade air and a cylinder of NO calibration gas in nitrogen. Gas phase titration of NO with ozone was used to test the converter efficiency. In addition, the background concentration of the humidified air was checked before each experiment. All zero checks gave a concentration of less than 0.3ppb NO_x.

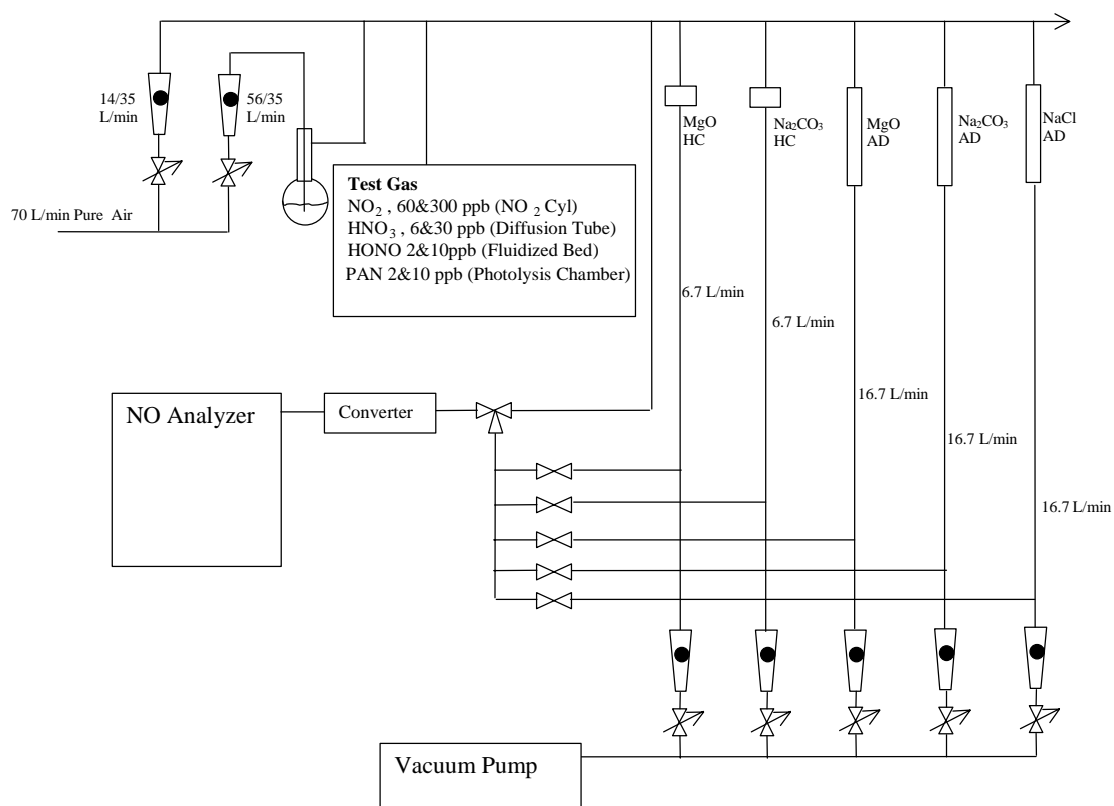

Figure 1. Schematic diagram of the apparatus to expose denuders and filters to HNO₃, NO₂, HONO, and PAN.

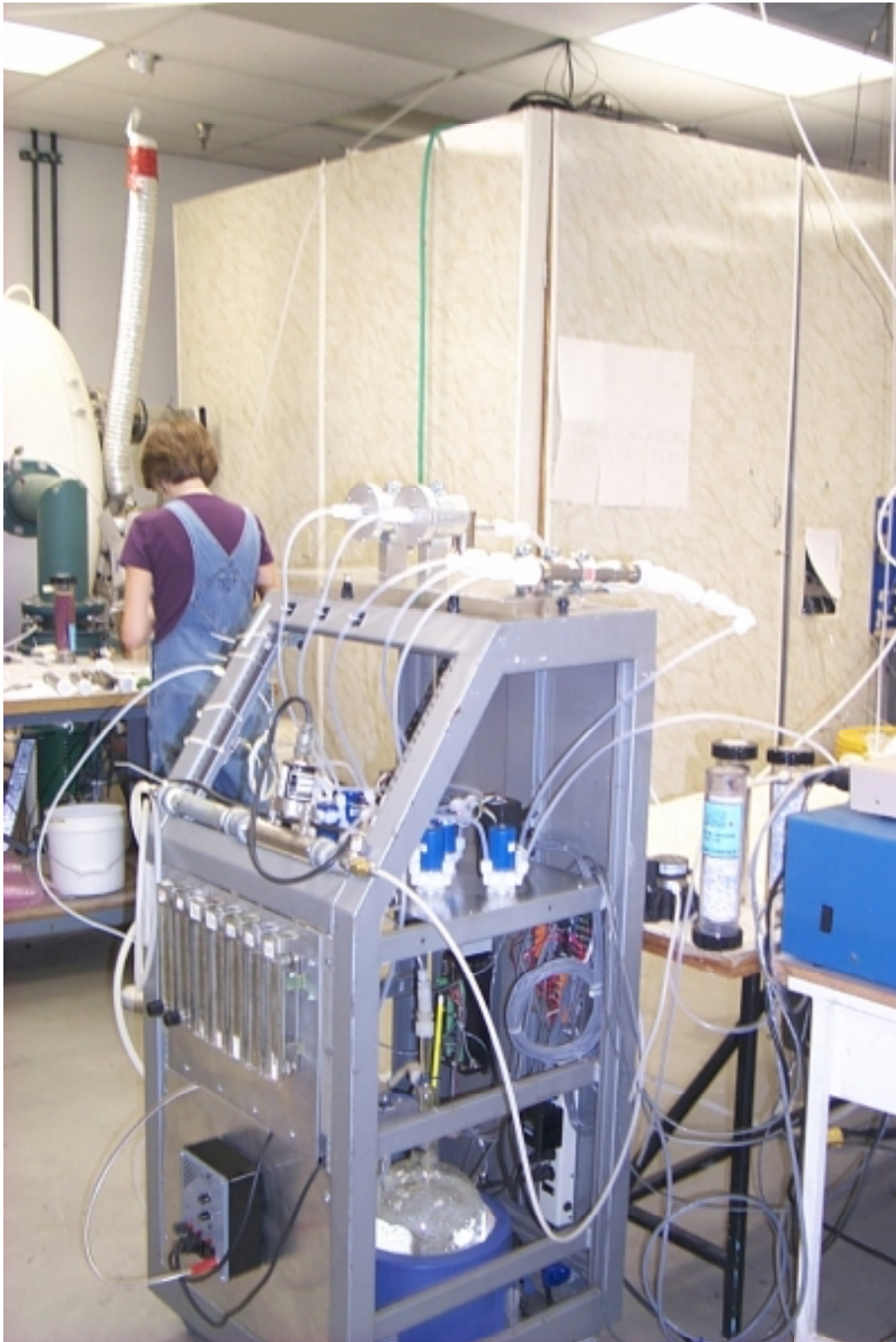

Figure 2. Photograph of the test apparatus.

Test Gas Generation and Purity Verification.

Nitrogen dioxide was generated by dilution of a 97.4 ppm compressed gas cylinder source in ultrapure N_2 (Scott Research Laboratories, San Bernardino, CA). Flow was maintained with a McMillan Company model 50 (0-50ml range) electron volumetric flow sensor.

Nitric acid vapor was generated with one of two VICI Metronics (Santa Clara, CA) diffusion vials (one model B for low range and one model C for high range) filled with reagent grade constant boiling (70%) nitric acid. The vials were maintained at 40°C in a water bath.

For the low-level HNO_3 concentrations the diffusion rate was determined by standard pH titration using NaOH as the base solution. Figure 3 is a plot of the pH titration of diffusion tube B, the lower concentration source for the HNO_3 measurements employed in this experiment.

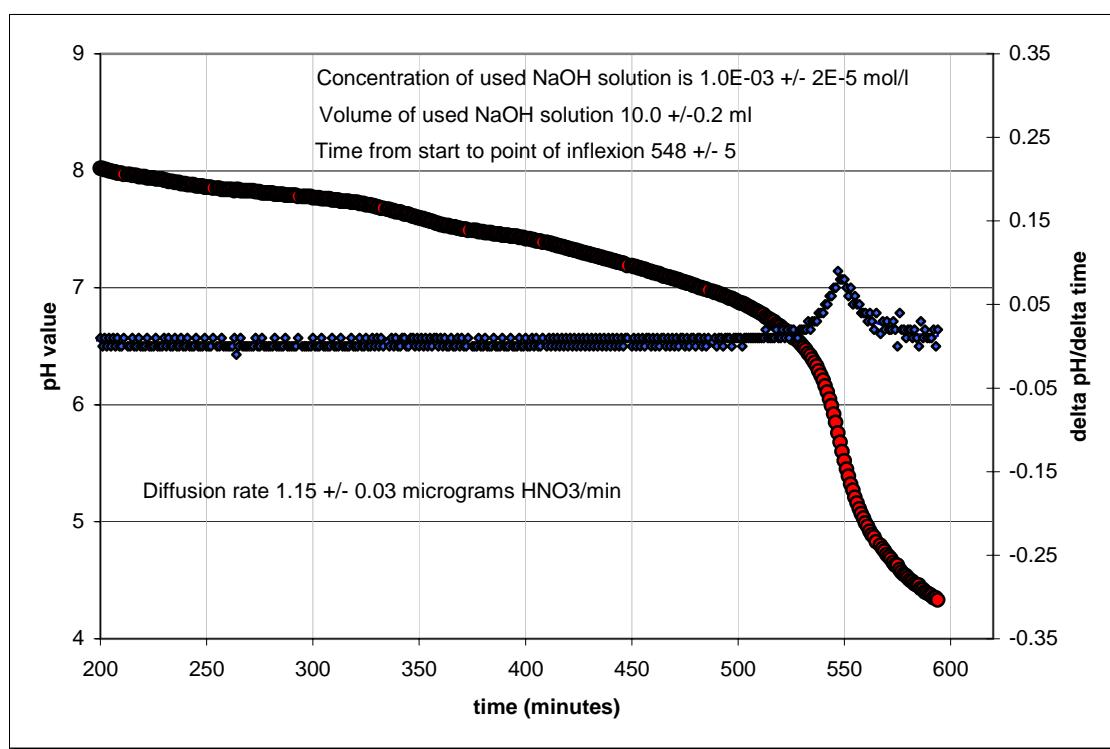

Figure 3. Plot of the pH titration curve for diffusion tube B.

This diffusion rate as determined by the pH titration was also challenged by using the same diffusion source as the source gas to a mid-infrared tunable diode laser. The tunable diode laser system was operational for two-channel monitoring, one for NO_2 and the other for HNO_3 . Figure 4 depicts this investigation of the HNO_3 acid diffusion source. The TDL was calibrated for HNO_3 using another diffusion tube source that generated 60 ppbV at 5 L/min. This source is used as part of the normal TDL systems calibration. The diffusion tube source used for the low concentrations was investigated for confirmation of the HNO_3 diffusion rate and for possible contamination of NO_2 . The diffusion tube HNO_3 was mixed with zero air and sampled by the TDL at 7 L/min, resulting in a mixing ratio of 68.7 ppbV with a standard deviation of 3.9 ppbV.

This measured value from the TDL was within a single standard deviation of the pH titration determined value for the HNO₃ diffusion tube B. Notice that during the measurement of the HNO₃ diffusion source, simultaneous values of NO₂ on average -0.3, were below the MDL of the tunable diode laser (1.0 ppbV) and had a standard deviation of 0.7.

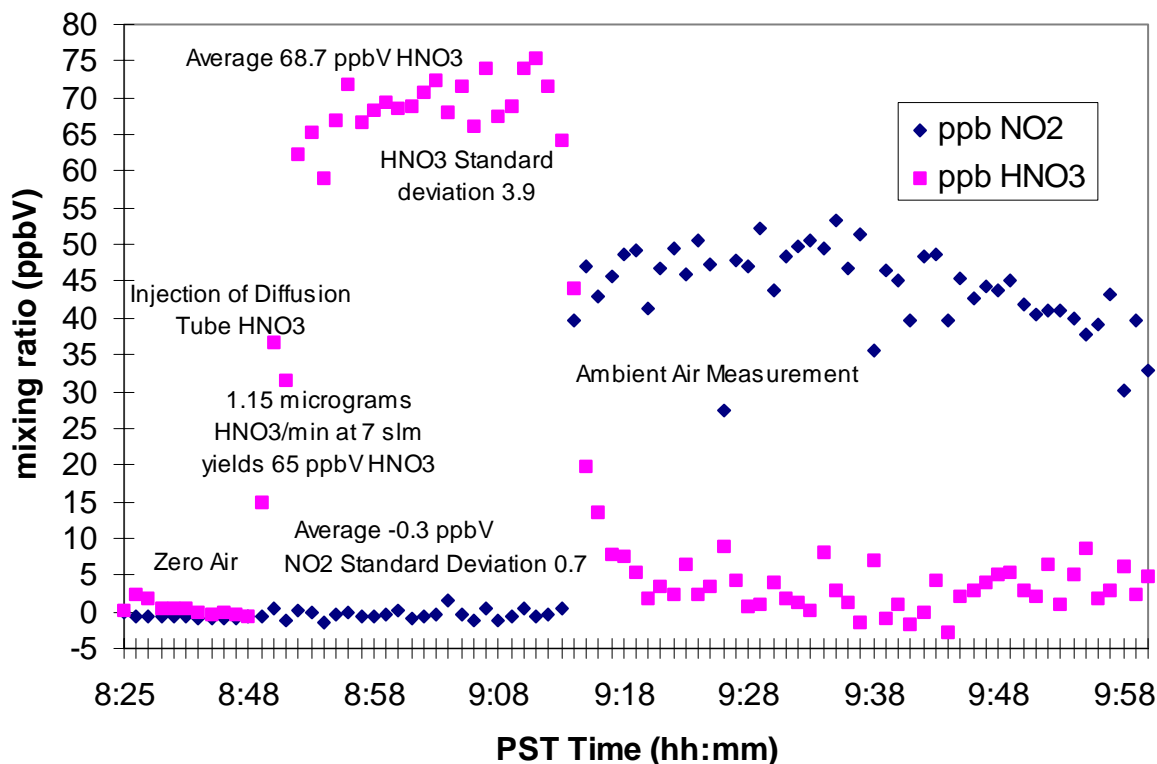

Figure 4. Plot of the TDL NO₂ and HNO₃ concentrations when sampling from diffusion tube B.

The lack of NO₂ was also confirmed from the observation of the normal concentrated aqueous acid (70% by weight) in the diffusion tubes throughout the experiment. The solution is colorless and only becomes yellow as a result of photochemical or thermal decomposition that yields NO₂.



The color of the solution showed no observable changes throughout the period of use. Although NO was an unlikely interferent, NO measurements were conducted throughout the experiment as a matter of the normal operational cycle of the TECO 42 with associated NO_y converter. There was never any detectable amount of NO.

Therefore, we concluded that there was no generation of NO_2 from this diffusion source and that the diffusion rate measured was consistent within the estimated errors of the two independent techniques.

For the higher HNO_3 concentrations, the diffusion rate was determined again by standard pH titration using NaOH as the base solution. Figure 5 is a plot of the pH titration of diffusion tube A, the higher concentration source for the HNO_3 measurements employed in this experiment.

This diffusion rate determined by the pH titration was challenged by repeating the pH test as the rate was far too high to be in the linear range of the tunable diode laser. The repeat test yielded a similar diffusion rate within the uncertainty of the measurement. Again we saw no discoloration of the 70% aqueous solution HNO_3 in the diffusion tube used for the high concentration during the experiments.

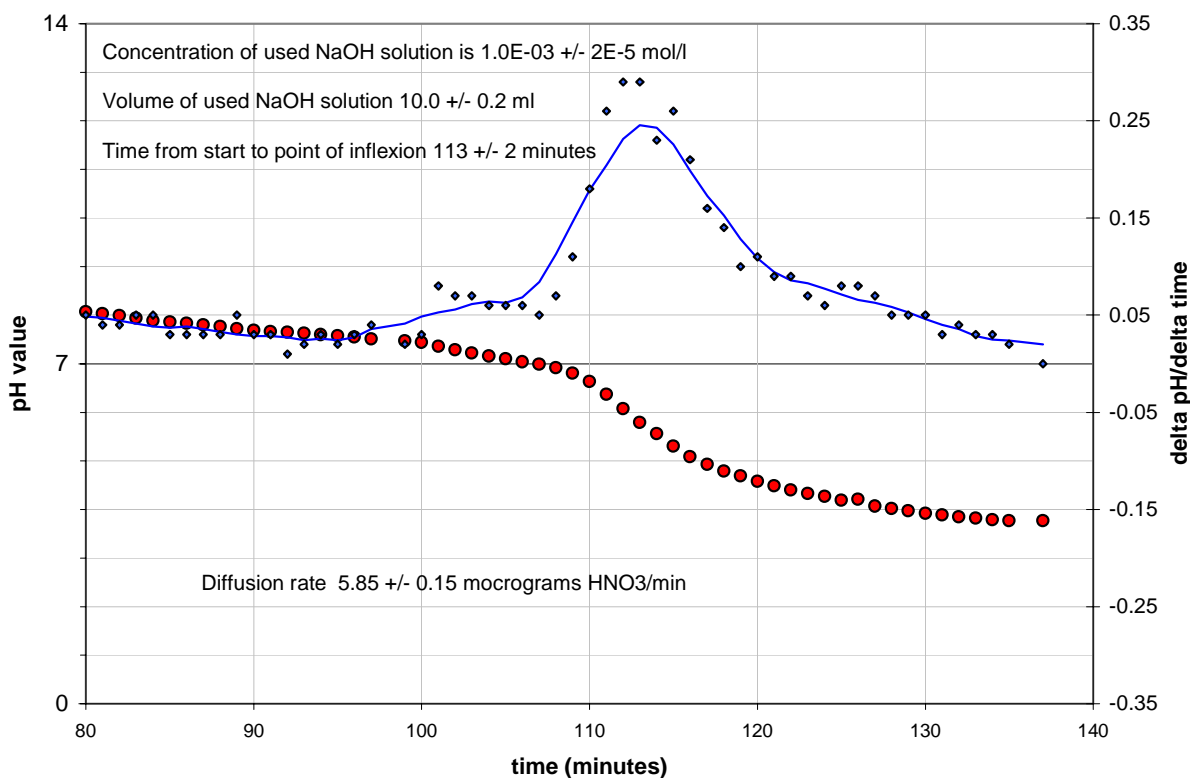

Figure 5. Plot of the pH titration curve for diffusion tube A.

Nitrous acid was generated using the method of reacting hydrochloric acid vapor generated in a diffusion tube with stirred granular sodium nitrite (Febo et al., 1995). Rotameters and needle valves were used to maintain the various flow rates of this generation system. The HONO concentration was stabilized by controlling both the flow rate and operating temperature of the oven that contained the HONO generating equipment. This system has been used in our laboratory for several years and has been found to be a stable and clean source of nitrous acid.

Regular maintenance on the HONO generating system requires a regular change of the sodium nitrite.

The purity of the nitrous acid source was determined by measuring the total NO_x concentration and then adding a NaCl coated filter (to remove any nitric acid and determine the amount of nitric acid by difference), followed by adding a sodium carbonate coated filter (to remove the HONO, thus leaving residual NO_2). These tests showed that the HONO contained approximately 3% of nitric acid and NO_2 . The NO_2 concentrations were verified several times using a TDLAS and a luminol-based NO_2 analyzer. In addition, the NO channel of the NO_x analyzer showed about 3% NO in the test mixture.

Peroxyacetyl nitrate was generated in a 5 m³ Teflon chamber (Carter et al., 1995) by photolyzing a mixture of 2ppm acetaldehyde, 50ppb chlorine, and 50ppb NO_2 . Acetaldehyde was maintained in excess to limit the amount of NO_2 remaining and the formation of HNO_3 . The concentration was verified with a gas chromatograph with a luminol detector (Fitz et al., 2001) calibrated with PAN generated in hexane (Holdren and Spicer, 1984). The PAN mixture was delivered to the test apparatus using a Teflon diaphragm pump (Virtual Industries part #VMP1625MX-24-50-NC). The flow rate was adjusted to obtain the desired concentration.

Analyzer Control and Data Logging. A Campbell model CR10 data logger was used to operate the solenoid valves in the test apparatus and to log the data from the NO_x analyzer. The data logger was programmed to alternate between sampling the concentration of the test gas before and after each denuder. Each sampling interval was six minutes, thus allowing the test gas concentration below the denuder to be determined once per hour. The data logger recorded the NO_x concentrations as one-minute averages. Data from the fourth minute of averaging were reported.

2.3 Experimental Matrix

A total of 21 denuder exposures were conducted varying the test gas concentration (from highest potential ambient to approximately 20% of that value), relative humidity, and length of exposure. Many of the 24-hour exposures showed no change in removal efficiency, and the next 24-hour period of testing was considered a replication of the first. A number of additional replicates were included. Table 1 shows the test matrix used. Experiment #2 used the same denuders that were used in Experiment #1 without recoating. These denuders, therefore, were exposed to nitric acid for two weeks. One test experiment (#5) was done using three denuders coated with the NaCl solution to further evaluate this method for selectivity for nitric acid. Table 2 shows the test matrix used for testing the nylon and sodium chloride and sodium carbonate coated quartz filters.

Table 1. Test matrix for denuder evaluation.

Exp #	Test Length, Hours	Test Gas	Conc	RH	Comments
1	124	HNO ₃	High	Low	
2	124	HNO ₃	High	Low	Using spent denuder for another week
3	165	HNO ₃	High	Low	Repeat of experiment 1
4	47	HNO ₃	Low	Low	
5	22	HNO ₃	Low	Low	All denuders NaCl coated
6	24	HNO ₃	Low	High	
7	188	HNO ₃	High	High	
8	49	NO ₂	High	High	
9	46	NO ₂	High	Low	
10	25	NO ₂	Low	Low	
11	160	NO ₂	Low	High	
12	42	HONO	High	Low	
13	23	HONO	High	High	
14	20	HONO	High	High	Repeat of 13
15	71	HONO	Low	High	
16	25	HONO	Low	Low	
17	71	HONO	Low	Low	Repeat of 16
18	15	PAN	High	Low	
19	8	PAN	High	High	
20	12	PAN	Low	High	
21	19	PAN	Low	Low	

Table 2. Matrix of tests for filter evaluation.

Exp #	Test Gas	Concentration	RH
22	NO ₂	High	Low
23	NO ₂	High	High
24	HONO	High	High
24	HONO	High	Low
26	PAN	High	Low
27	PAN	High	High

3. Results and Discussion

3.1 Removal Efficiency

The results of the experiments will be described by the efficiency of denuders and filters, expressed as a percentage, to collect the test gas (whether removal of the test gas is desirable or not). Removal efficiency is defined as follows:

$$E = 100 \cdot (C_1 - C_2) / C_1$$

where C_1 is the concentration of the test gas prior to the denuder or filter and C_2 is the concentration after.

3.2 MgO-Coated Annular Denuder

Table 3 summarizes all the experiments performed exposing the annular denuders to the test gases (the other denuders are included in this summary table). For nitric acid the removal efficiency is generally over 80% even for tests periods of nearly eight days at 46ppb. The low-concentration tests had generally lower efficiencies, but these are subject to more error due to zero drift than are the high concentrations. The low-concentration, high-humidity test showed significantly lower removal efficiency than the others. The removal efficiency for NO_2 was consistently about 5%, indicating that this species is not readily removed. This few percent could be due to minor impurities in the NO_2 such as HONO in the compressed gas cylinder. HONO was removed nearly as effectively as nitric acid. Results from these two acid gases agreed in that the lowest removal efficiency was the case with low concentration and high humidity. PAN was removed with variable efficiencies, ranging from 40 to 80%. There was not any apparent trend with either humidity or concentration. Note that the PAN tests were conducted for less than 24 hours due to the volume of the PAN mixture available in the chamber.

Figure 6 summarizes the results of all the experiments by presenting the initial denuder removal efficiency and the efficiency after 1, 4, and 24 hours (or the last test point if the exposure lasted less than 24 hours) and the average for the exposure period for all four test gases. Appendix A contains the detailed time series plots. Except for a few outliers, there is little difference in removal efficiency as the testing progresses. This indicated that the denuder has capacity to remove high concentrations of nitric and nitrous acids. The high-RH, low-concentration test indicated that the denuder was initially somewhat effective in removing NO_2 , but the efficiency dropped to background within four hours. This was likely a valid result particular to the coating material since the MgO-coated honeycomb denuder also showed this behavior for only this test condition. Experiment #18 showed an unexplainable steep drop off in the removal efficiency for PAN during the last two hours of the test.

Table 3. Summary of removal efficiency for denuders.

Exp #	Test Gas	Ave Conc, ppb	RH	Period Average Efficiency (%)				
				Annular MgO	Annular Na ₂ CO ₃	Annular NaCl	Honeycomb MgO	Honeycomb Na ₂ CO ₃
1	HNO ₃	51.5	30%	95.1	84.1	66.5	92.4	93.1
2	HNO ₃	49.6	30%	91.2	26.6	57.3	88.0	87.9
3	HNO ₃	51.0	30%	92.5	76.7	59.5	89.9	90.0
4	HNO ₃	9.6	30%	82.1	81.2	59.7	82.3	81.4
6	HNO ₃	7.9	70%	63.2	64.3	52.9	52.1	64.9
7	HNO ₃	46.3	70%	83.0	77.4	61.5	79.6	82.1
8	NO ₂	69.2	70%	4.0	3.9	3.2	2.0	0.0
9	NO ₂	76.4	30%	5.7	5.3	4.8	4.4	3.0
10	NO ₂	16.7	30%	5.4	4.9	4.7	2.1	1.7
11	NO ₂	16.3	70%	5.3	4.5	3.9	3.6	2.2
12	HONO	30.2	30%	92.5	85.9	6.5	91.9	60.3
13	HONO	30.8	70%	87.2	88.1	20.7	79.2	86.8
14	HONO	30.8	70%	83.8	85.3	24.1	85.3	78.4
15	HONO	9.2	70%	76.7	78.3	25.1	66.6	70.0
16	HONO	8.6	30%	82.3	80.7	26.3	80.5	79.3
17	HONO	7.7	30%	85.2	72.8	25.1	81.0	79.9
18	PAN	14.8	30%	69.5	27.4	26.9	77.6	27.7
19	PAN	3.8	70%	62.6	22.7	22.8	66.9	19.9
20	PAN	25.2	70%	80.3	32.7	32.7	80.5	32.4
21	PAN	25.2	30%	38.6	9.0	8.8	44.2	4.5

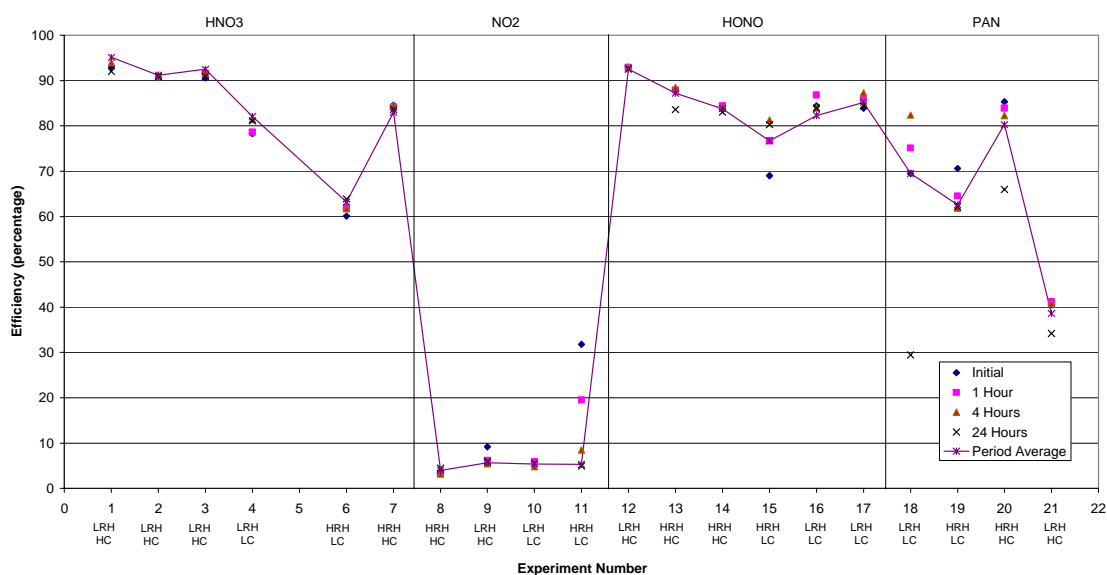

Figure 6. Summary of removal efficiency tests for the MgO coated annular denuders.

3.3 Sodium Carbonate-Coated Annular Denuder

Table 3 summarizes all the experiments performed exposing this denuder to the test gases. For nitric acid the removal efficiency is generally over 70% even for tests periods of nearly 15 total days (the denuders were not recoated after Experiment #1) at 50 ppb. As with the magnesium oxide coating, the removal efficiency for NO₂ was low (5%) and that for HONO was high (typically 80%). PAN, however, was collected at significantly lower efficiency than the magnesium oxide coating.

Figure 7 summarizes the results of all the experiments by presenting the initial denuder removal efficiency and the efficiency after 1, 4, and 24 hours (or the last test point if the exposure lasted less than 24 hours) and the average for the exposure period for all the four test gases. Appendix A contains the detailed time series plots. During Experiment #1 the nitric acid removal efficiency at 24 hours dropped appreciably and was less than 40% when the same denuder was started for Experiment #2. Figure 8 is a time series plot of the nitric acid concentration before and after the denuder and the calculated denuder efficiency. After about two days of sampling 50 ppb of nitric acid, the denuder removal efficiency started to drop, and the efficiency dropped from nearly 90% to 50% over the next five days. This denuder had apparently used up much of its adsorption capacity. This drop-off in removal efficiency was not observed in the parallel experiment that used the magnesium oxide coated annular denuder, even after 13 days of exposure, thus indicating that magnesium oxide coating has a much higher capacity than carbonate. A similar efficiency drop-off was also observed in the replicate test (Experiment #3). Experiment #7 was similar to Experiments #1 and #3, but at high humidity instead of low. Figure 9 is the time series plot of efficiency for this test and a slower drop off is noted after two days. It appears that humidity aids the carbonate in adsorbing nitric acid. This might be due to increasing the mass transfer of carbonate to the surface of the denuder. Figure 10 shows a similar drop-off in efficiency when HONO was the test gas and the RH was low. The efficiency drop was much less under high RH conditions.

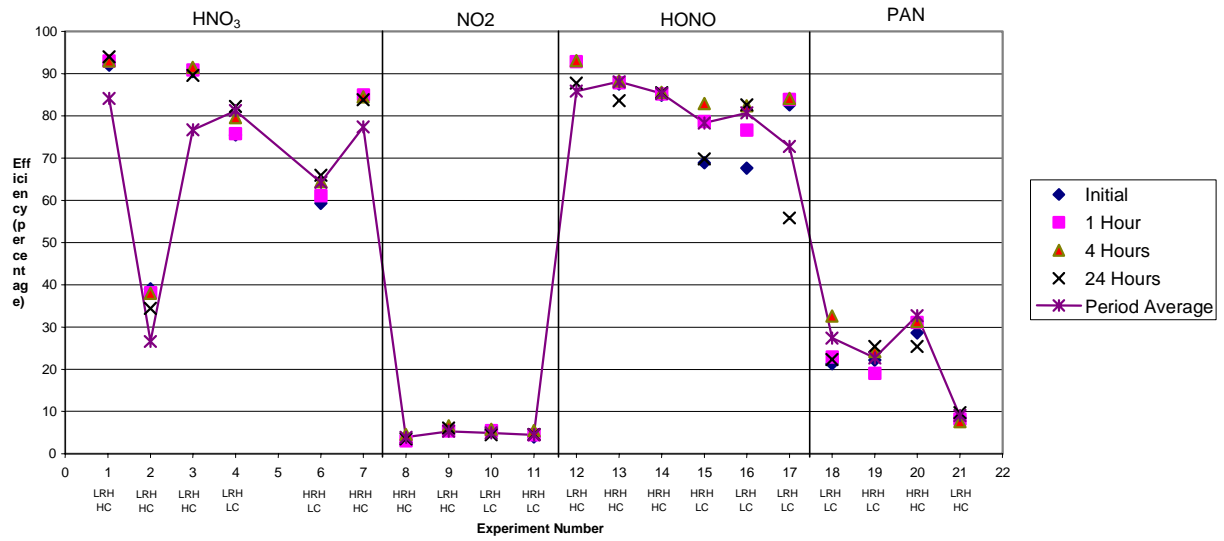

Figure 7. Summary of removal efficiency tests for the sodium carbonate coated annular denuder.

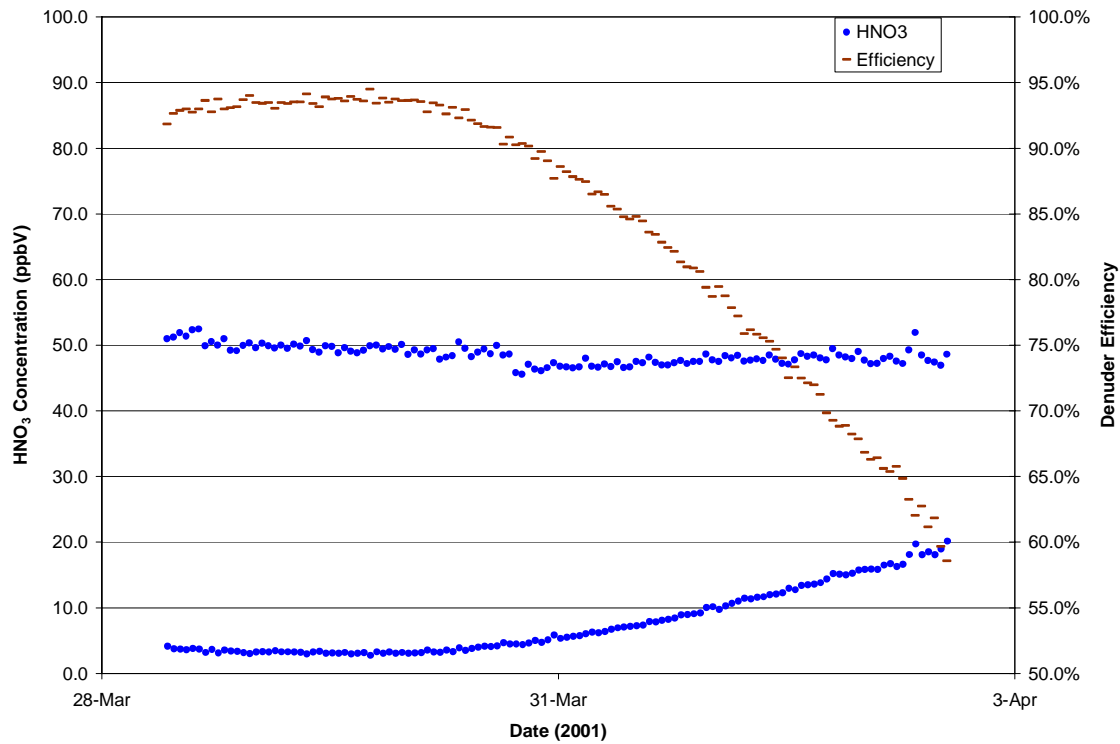

Figure 8. Time series plot of HNO₃ removal efficiencies and concentrations and before and after the sodium carbonate coated annular denuders under low humidity conditions.

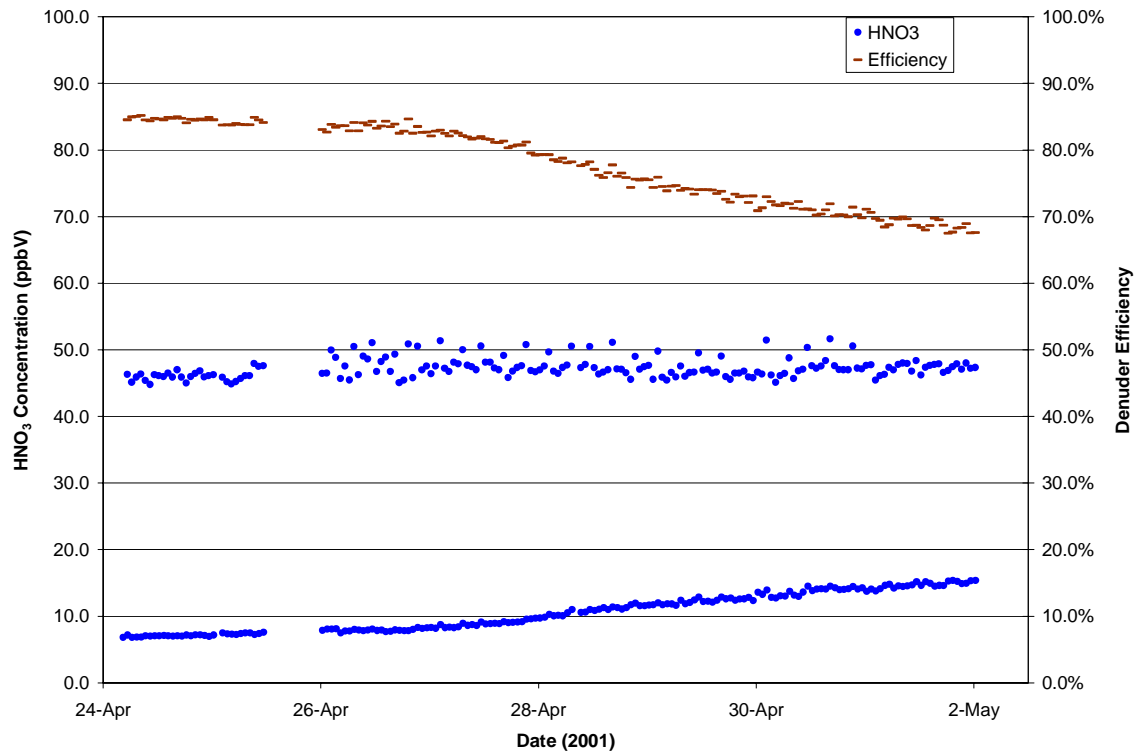

Figure 9. Time series plot of HNO₃ removal efficiencies and concentrations and before and after the sodium carbonate coated annular denuders under high humidity conditions.

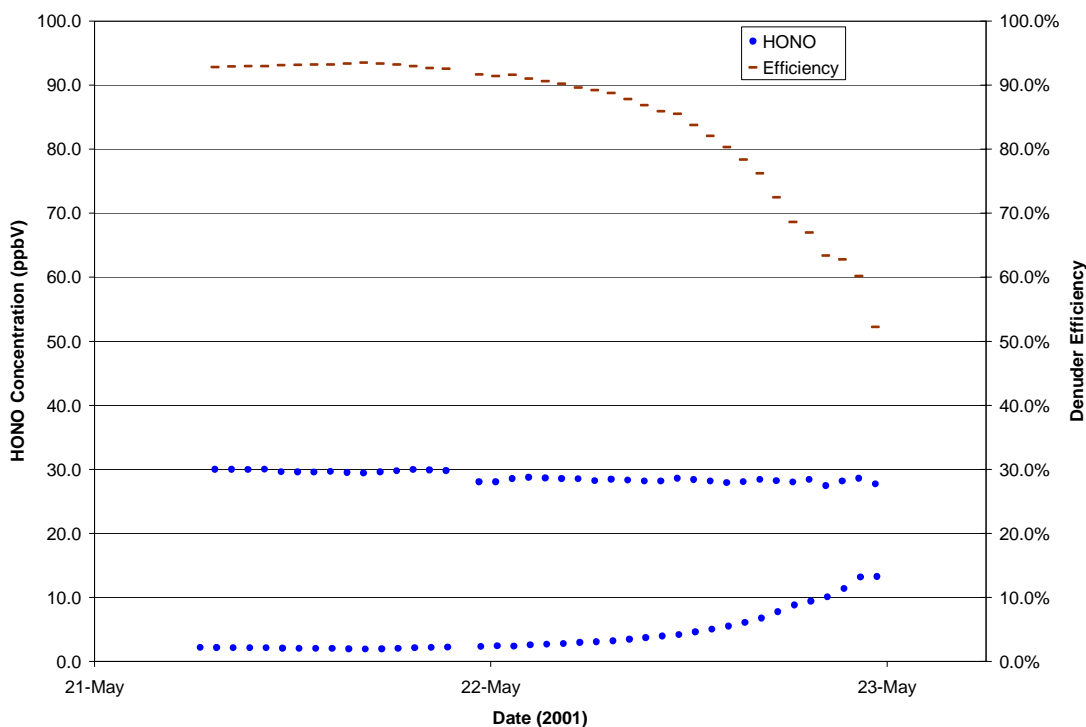

Figure 10. Time series plot of HONO removal efficiencies and concentrations and before and after the sodium carbonate coated annular denuders under low humidity conditions.

3.4 Sodium Chloride-Coated Annular Denuder

Table 3 summarizes all the experiments performed exposing this type of denuder to the test gases. For nitric acid the removal efficiency, with the period average ranging from 53 to 67%, is significantly lower than for the annular denuders with sodium carbonate or magnesium oxide coatings. The removal efficiency for NO_2 was as low and similar to that observed with the other two coating materials while that for HONO and PAN was much lower, approximately 25%. These results show that NaCl coating, while somewhat less efficient in scrubbing nitric acid, is much less efficient in removing HONO and PAN and, therefore, more selective.

Figure 11 summarizes the results of all the experiments by presenting the initial denuder removal efficiency and the efficiency after 1, 4, and 24 hours (or the last test point if the exposure lasted less than 24 hours) and the average for the exposure period for all of the four test gases. Appendix A contains the detailed time series plots. For nitric acid the efficiency tends to drop somewhat in the removal efficiency but remains at a constant level during the 13 days of exposure conducted during tests #1 and #2. For other test gases the removal efficiency remains fairly constant without any clear-cut trends.

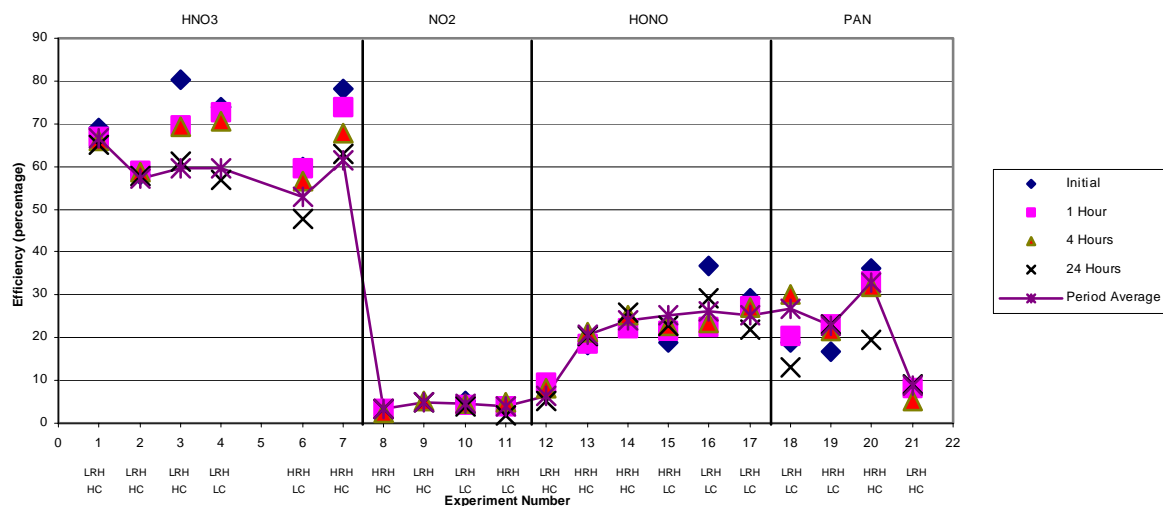

Figure 11. Summary of removal efficiency tests for the sodium chloride coated annular denuders.

3.5 Magnesium Oxide-Coated Honeycomb Denuder

Table 3 summarizes all the experiments performed exposing the honeycomb denuders to the test gases. The period average removal efficiencies for all of the test gases were similar to that obtained for this coating on annular denuders. The low-concentration/high-humidity experiment (#15) with nitric acid also showed significantly lower removal efficiency than the others.

Figure 12 summarizes the results of all the experiments by presenting the initial denuder removal efficiency and the efficiency after 1, 4, and 24 hours (or the last test point if the exposure lasted less than 24 hours) and the average for the exposure period for all four subject gases. Appendix A contains the detailed time series plots. With several exceptions during the PAN and HONO testing, the removal efficiencies generally did not go down with sampling time. Experiment #11 showed a significant initial adsorption efficiency of NO_2 at low concentrations and high RH followed by a rapid drop in efficiency. This is consistent with the behavior of the similarly coated annular denuder. Figure 13 shows the time series plot for Experiment #13 with HONO as the test gas (high RH, high concentration). In this figure the removal efficiency slowly and steadily dropped as a function of time. This phenomenon was not observed in the replicate test (#14), but it was in the low-concentration/high-humidity test (#15). Slow drops in removal efficiency were also observed for all of the PAN exposure tests.

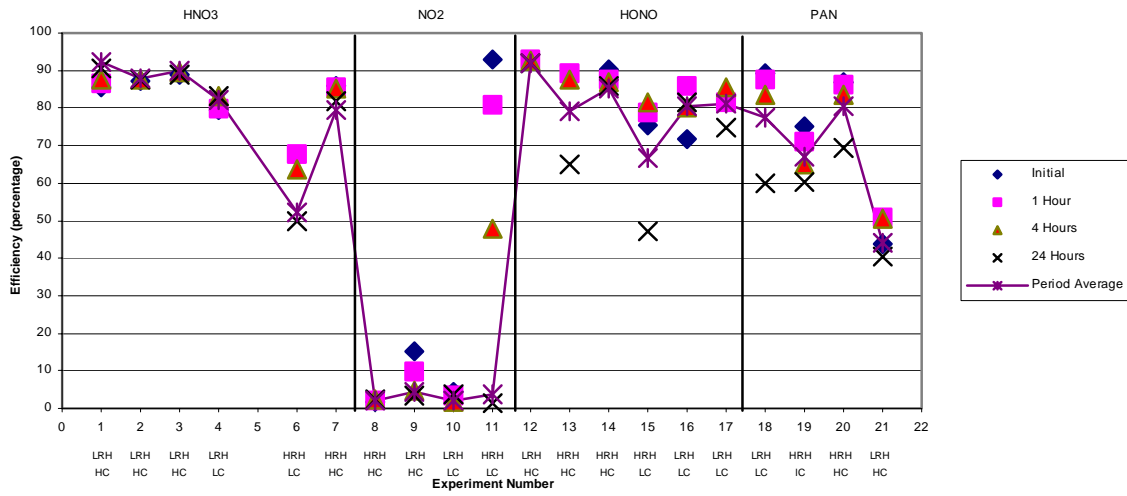

Figure 12. Summary of removal efficiency tests for the magnesium oxide coated honeycomb denuders.

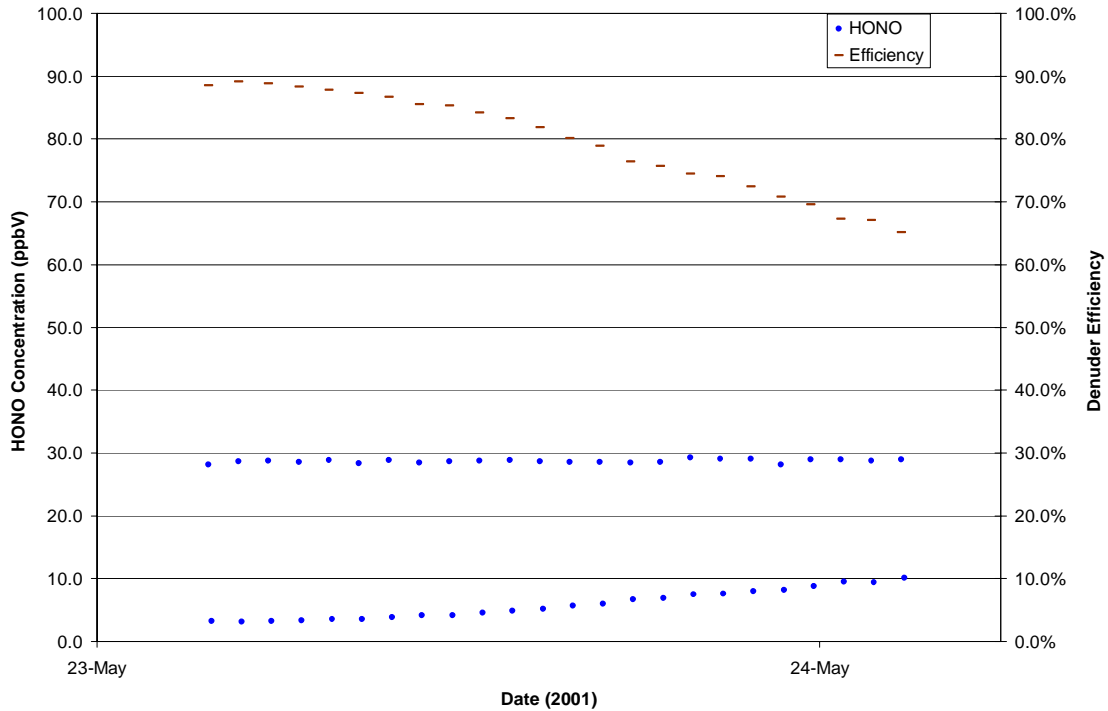

Figure 13. Time series plot of HONO removal efficiencies and concentrations and before and after the magnesium oxide coated honeycomb denuders under high concentration and humidity conditions.

3.6 Sodium Carbonate-Coated Honeycomb Denuder

Table 3 summarizes all the experiments performed exposing the honeycomb denuders to the test gases. The period average removal efficiencies for all of the test gases were similar to that obtained for this coating on annular denuders. The low-concentration/high-humidity test with nitric acid also showed significantly lower removal efficiency than the others.

Figure 14 summarizes the results of all the experiments by presenting the initial denuder removal efficiency and the efficiency after 1, 4, and 24 hours (or the last test point if the exposure lasted less than 24 hours) and the average for the exposure period for all four test gases. Appendix A contains the detailed time series plots. A noticeable difference was that the removal efficiency for nitric acid in Experiment #2 did not drop, as was the case for the similarly coated annular denuder. This indicates that the honeycomb denuder has higher capacity than the annular denuder does. For HONO Experiment #12 (low RH, high concentration) and #15 (high RH, low concentration) the removal efficiency for HONO starting dropping almost immediately. Figure 15 shows the time series plot of concentration and removal efficiency for Experiment #12. This drop-off is similar to that observed with the magnesium oxide coated denuder sampling HONO in Tests #13 (see Figure 9) and #15. Only slight drop-offs were observed in the other HONO tests.

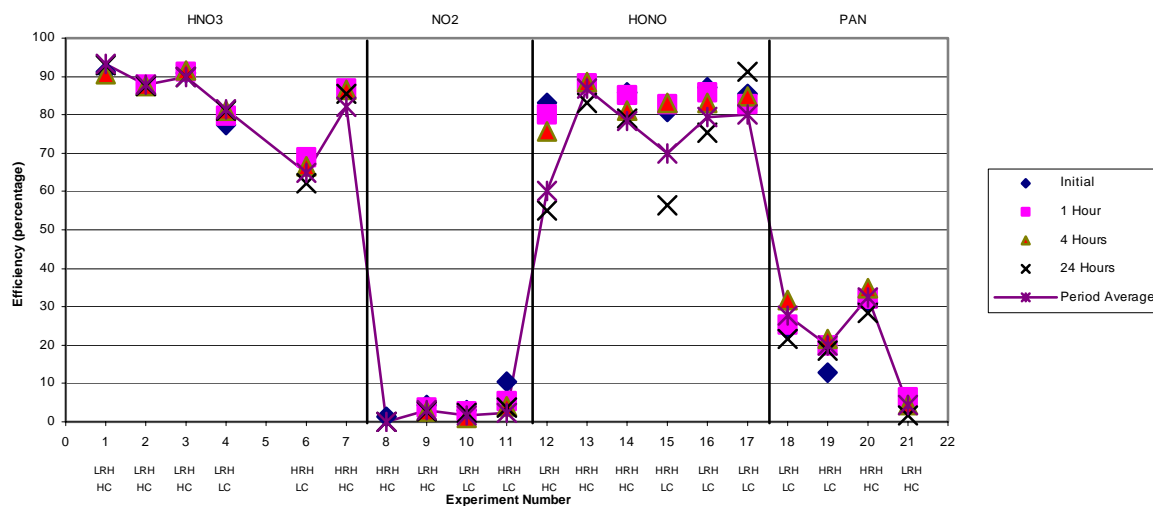

Figure 14. Summary of removal efficiency tests for the sodium carbonate coated honeycomb denuders.

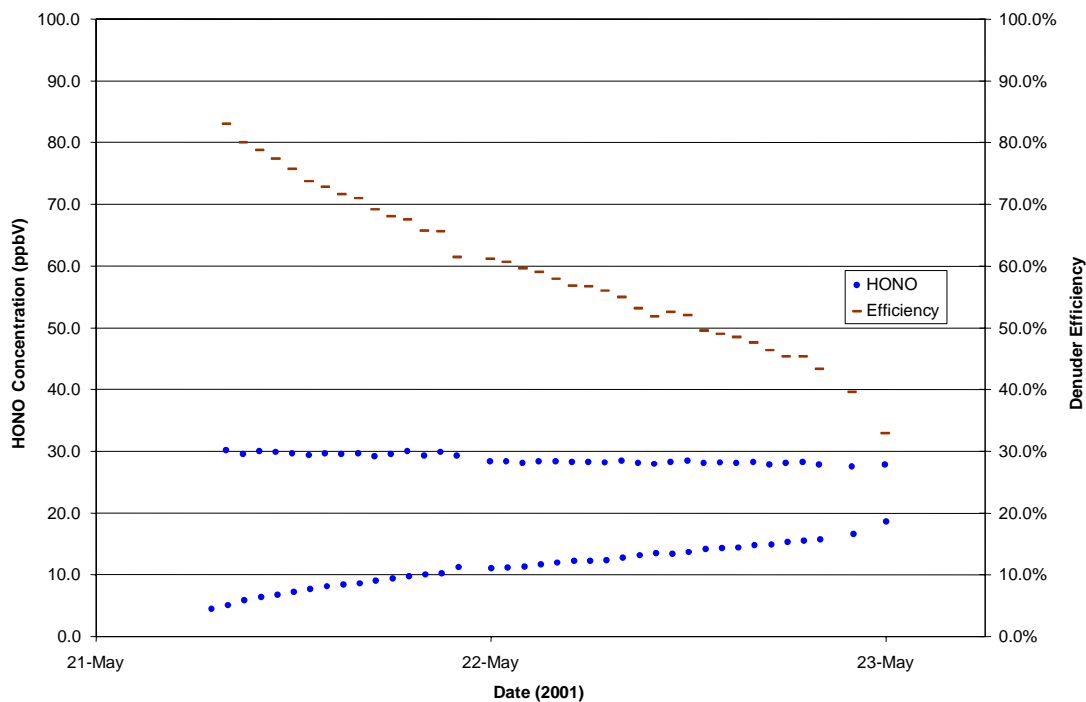

Figure 15. Time series plot of HONO removal efficiencies and concentrations and before and after the sodium carbonate coated honeycomb denuder under high concentration and low humidity conditions.

3.7 Sodium Chloride Denuders

While sodium chloride appeared to be a more selective denuder coating for nitric acid compared with sodium chloride or carbonate, the removal efficiency when used to coat annular denuders was never more than 80% and rapidly stabilized to about 60%. Clearly this would be a problem in sampling ambient air as two or three denuders in series would be required. Experiment #1 with nitric acid showed that the honeycomb denuder design appeared to have higher capacity to adsorb nitric acid than the annular ones when sodium carbonate was the coating substrate. Therefore, a test was conducted (Experiment #5) to determine the efficiency of sodium chloride-coated honeycomb denuders. A combination of low concentration and humidity was used as this was generally the combination that led to the lowest overall removal efficiencies for nitric acid (regardless of the denuder type or coating substrate). Figure 16 shows the results. The removal efficiency for the annular denuders drop from 80% and stabilize after 16 hours to 55% as previously observed. The efficiency of the honeycomb denuder, however, remains near 80%. A sodium chloride-coated honeycomb denuder may therefore be a viable combination with which to determine nitric acid concentrations in the air.

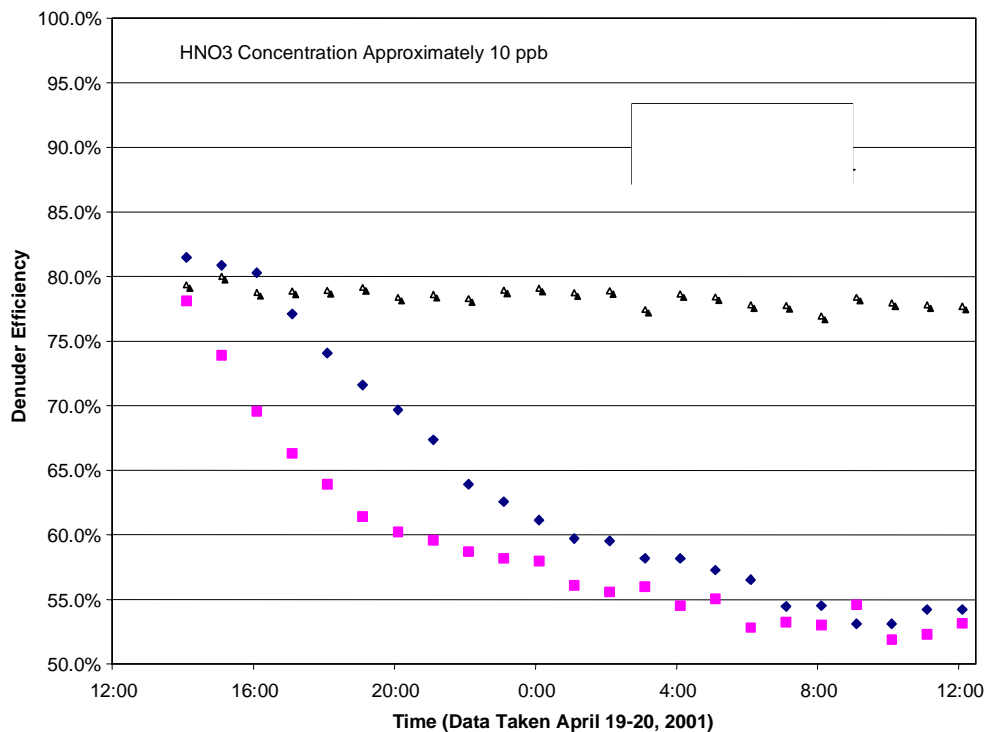

Figure 16. The removal efficiency of sodium chloride coated annular and honeycomb denuders for 10 ppb of nitric acid at 30% RH.

3.8 Filter Testing

Nylon. Figure 17 summarizes the results of all the experiments by presenting the initial filter removal efficiency and the efficiency after 1, 4, and 24 hours (or the last test point if the exposure lasted less than 24 hours) and the average for the exposure period for all three test gases. Appendix B contains the detailed time series plots. Although high initial removal efficiency was observed for Experiments #22 and #24, the efficiency immediately dropped and remained stable there after. Nylon filters appear to have a small efficiency (10-20%) to collect NO_2 and HONO but almost no affinity for PAN. These results for NO_2 and HONO are consistent with those previously reported (Perrino et al., 1990). There was no significance difference in removal efficiency due to RH. Table 4 list the overall collection efficiency determined by the NO_x analyzer and compares the amount of nitrate found on the filter with that calculated from the average concentration difference before and after the filter. For NO_2 the amount of nitrate on the nylon filter was about half of that calculated. It is likely that the NO_2 retained by the filter decomposed to both nitrate and nitrite. In the absence of ozone, the nitrite would not be oxidized to nitrate and therefore would not be accounted for in the chemical analysis. For HONO even less was found on the filter compared to the calculated amount, thus indicating that most of the HONO was retained as nitrite. With PAN this pattern was reversed, with the amount found on the filter being greater than the amount calculated. This may be due to measurement errors due to low PAN concentrations and possible hang up of nitrogenous species in the NO_x analyzer.

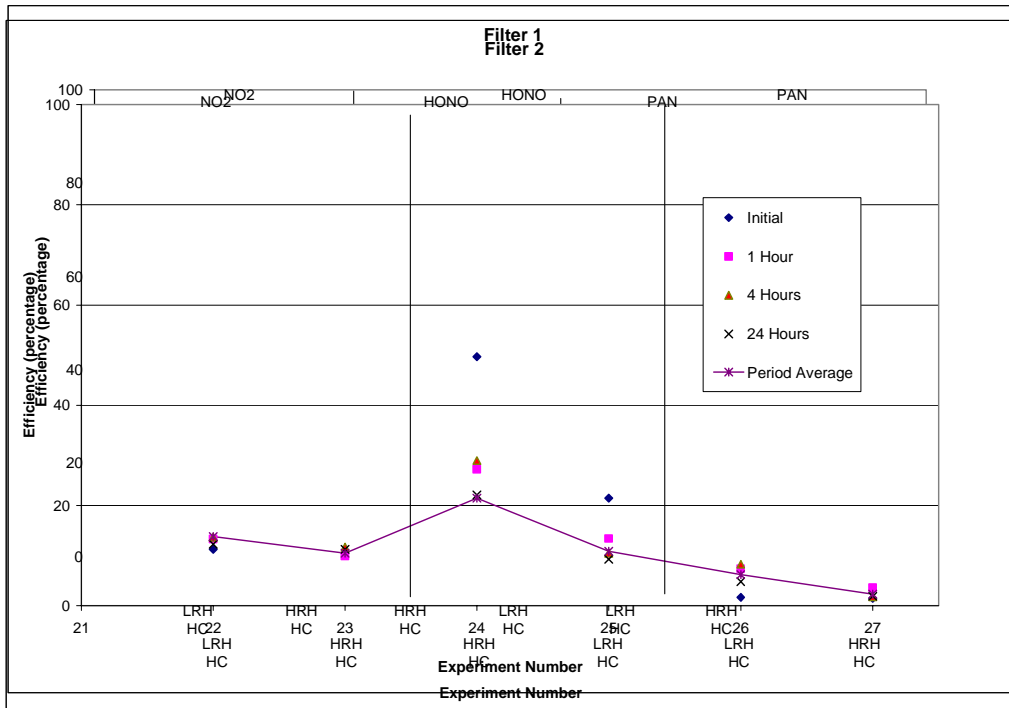

Figure 17. Summary of removal efficiency tests of the replicate nylon filters for removing NO₂, HONO and PAN.

Table 4. Summary of filter data.

Filter Type	Test Gas	Nominal Conc, ppb	RH	Period Ave Efficiency %	Nitrate Collected, ugN	N from Concentration Difference, ugN
Nylon	NO ₂	30	30	17	11.1	26.1
Nylon	NO ₂	30	30	14	11.5	20.6
NaCl Qz	NO ₂	30	30	8	9.3	30.0
CO ₃ -Qz	NO ₂	30	30	3	4.7	12.5
CO ₃ -Qz	NO ₂	30	30	4	6.0	13.7
Nylon	NO ₂	29	70	12	15.2	31.3
Nylon	NO ₂	29	70	11	14.2	27.7
NaCl Qz	NO ₂	29	70	6	13.1	16.1
CO ₃ -Qz	NO ₂	29	70	5	11.2	13.4
CO ₃ -Qz	NO ₂	29	70	3	11.3	8.9
Nylon	HONO	25	70	29	2.3	43.2
Nylon	HONO	25	70	23	1.2	33.4
NaCl Qz	HONO	25	70	45	0.6	60.2
CO ₃ -Qz	HONO	25	70	68	0.6	86.9
CO ₃ -Qz	HONO	25	70	71	0.8	93.0
Nylon	HONO	26	30	13	7.7	18.0
Nylon	HONO	26	30	11	4.6	16.4
NaCl Qz	HONO	26	30	32	0.9	45.9
CO ₃ -Qz	HONO	26	30	82	0.8	114.8
CO ₃ -Qz	HONO	26	30	83	1.1	116.5
Nylon	PAN	9	30	5	12.5	1.5
Nylon	PAN	9	30	6	13.5	1.8
NaCl Qz	PAN	9	30	NA	13.5	NA
CO ₃ -Qz	PAN	9	30	2	12.1	0.7
CO ₃ -Qz	PAN	9	30	5	11.9	1.5
Nylon	PAN	9	70	2	15.7	0.9
Nylon	PAN	9	70	2	15.2	0.9
NaCl Qz	PAN	9	70	NA	15.8	NA
CO ₃ -Qz	PAN	9	70	3	14.9	1.3
CO ₃ -Qz	PAN	9	70	4	14.5	1.7

NaCl Coated Quartz. Figure 18 summarizes the results of all the experiments by presenting the initial filter removal efficiency and the efficiency after 1, 4, and 24 hours (or the last test point if the exposure lasted less than 24 hours) and the average for the exposure period for all three test gases. Appendix B contains the detailed time series plots. NaCl coated filters also appear to have a small efficiency (less than 10%) to collect NO_2 while they were relatively efficient in removing HONO (30-50%). There was no data available for PAN due to equipment failure. Table 4 compares the amount of nitrate found on the filter with that calculated from the NO_x concentration difference before and after the filter. The results are similar to that observed for the nylon filter.

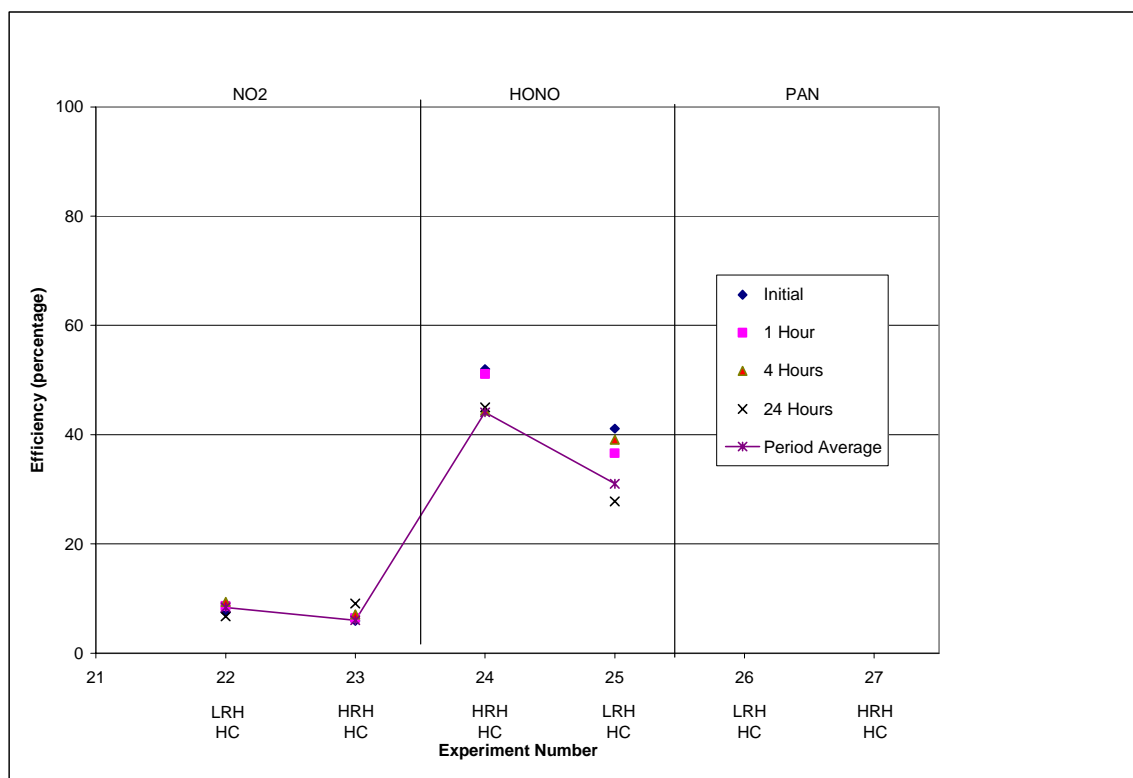

Figure 18. Summary of removal efficiency tests of the NaCl coated quartz filters for removing NO_2 , HONO and PAN.

Na₂(CO₃) Coated Quartz. Figure 19 summarizes the results of all the experiments by presenting the initial filter removal efficiency and the efficiency after 1, 4, and 24 hours (or the last test point if the exposure lasted less than 24 hours) and the average for the exposure period for all three test gases. Appendix B contains the detailed time series plots. The removal efficiency is very low for NO_2 and PAN while that for HONO is nearly 80%. These results also appear to be independent of the RH. Table 4 compares the amount of nitrate found on the filter with that calculated from the NO_x concentration difference before and after the filter. The results are similar to that observed for the nylon filter and NaCl coated filters.

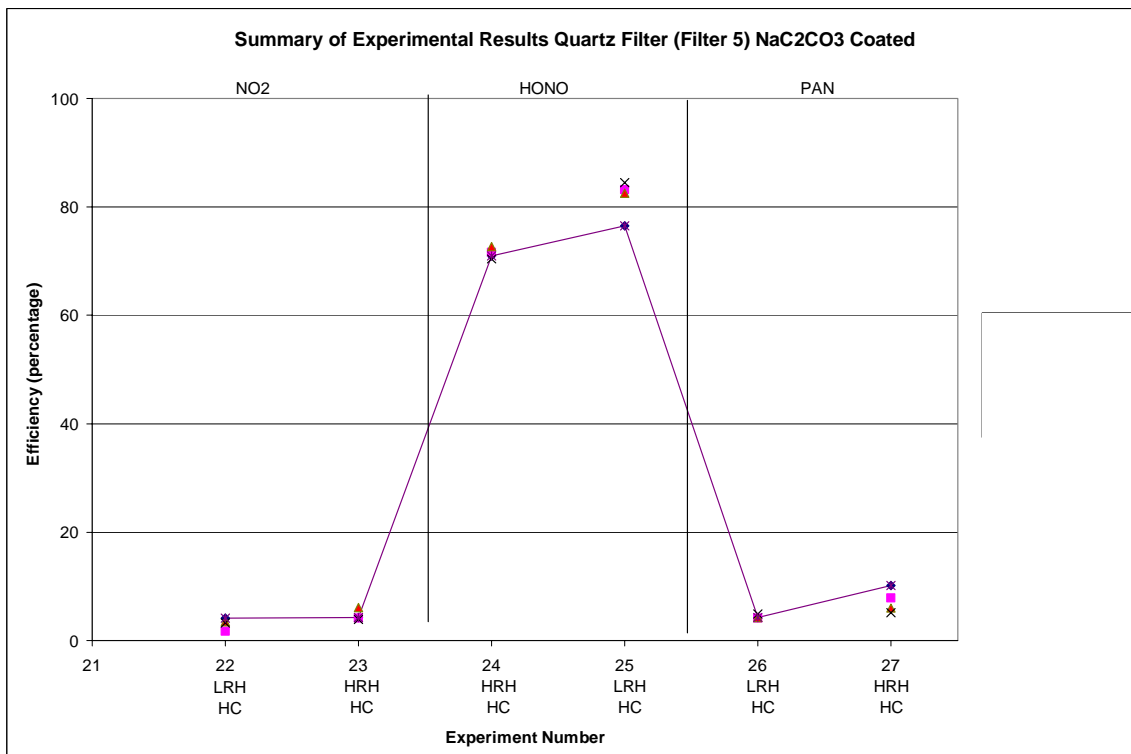
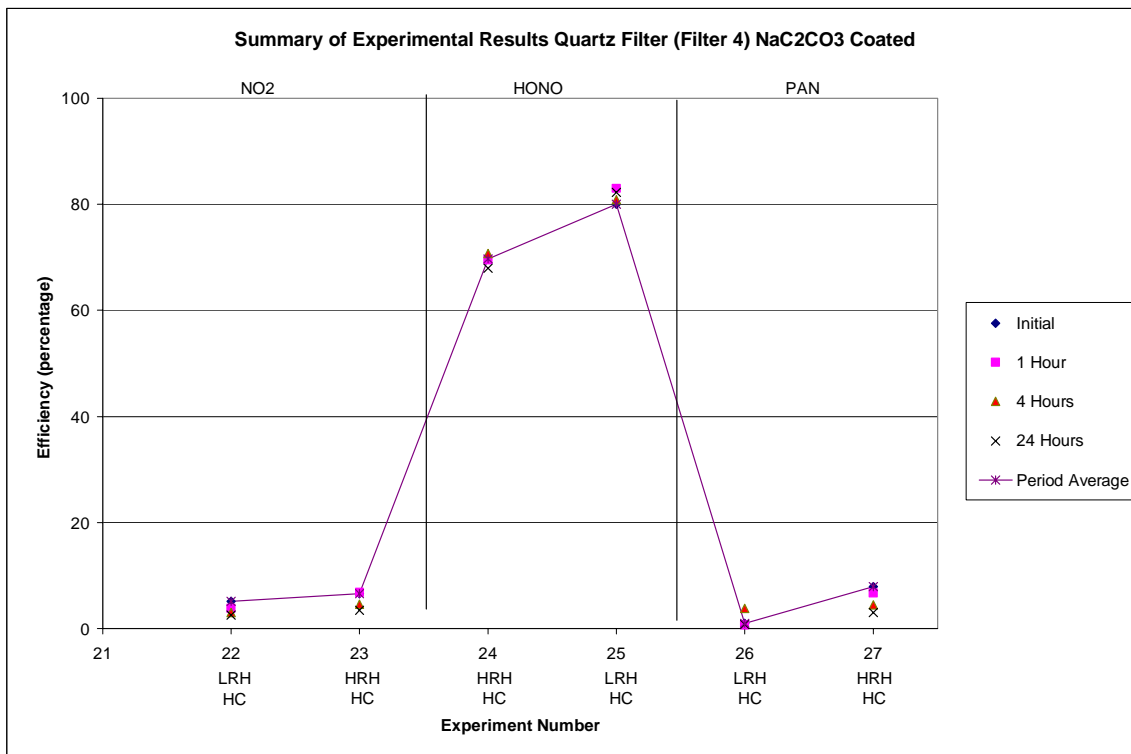

Figure 19. Summary of removal efficiency tests of the replicate Na₂(CO₃) coated quartz filters for removing NO₂, HONO and PAN.

3.9 Additional QC Checks to Evaluate the NO_y Analyzer Memory Effect

It is likely that the reported nitric acid removal efficiencies were biased low due to the time lag of the analyzer when switched from measuring nitric acid the before denuder to measuring it after the denuder. This is known as the “memory effect” and has been routinely reported when measuring NO_y in the atmosphere. It was necessary to sample repeatedly before and after the denuder to characterize the removal of nitric acid. We could have sampled only after the denuder and allowed the analyzer to reach its actual zero point, but then we could not monitor any changes in the input concentration. In addition, as nitric acid penetrated some of the denuders, the memory effect would again become significant.

We did perform two experiments to evaluate the memory effect. In the first we stopped the routine cycling between before and after the denuder and sampled only after the denuder. In addition we added NaCl coated filters after the denuders, which have been shown to be specific in removing nitric acid (Perino et al., 1990). By doing this we expected to scrub out most of the HNO₃ prior to the entrance of the TECO NO_y converter. The HNO₃ source response was measured prior to the experiment and found to be on average 49.4 ppbV with a standard deviation of 1.4 ppbV. The test was conducted at 30% humidity. Figure 20 shows the results of four hours of sequentially sampling below all five denuders at a six-minute cycling interval. All one-minute data are illustrated here since we do not expect a need for the instrument to equilibrate since the sample is expected to be free of any nitric acid. Each of the denuder paths displayed similar response, with initial values of about 0.8 ppbV of NO_y and dropping to 0.5 ppbV after approximately 4 hours. This 0.3 ppbV drop is likely from the converter volatilizing deposited HNO₃ on its interior surfaces over the four-hour period. This shows that there are no nitrogenous species exiting the denuder other than perhaps nitric acid.

In the second experiment we measured the response time for the NO_y analyzer after it cycled from measuring nitric acid to zero air. Figure 21 shows the result. The instrument sampled the high diffusion source HNO₃ for a period of 24 hours and yielded an average concentration of 45.52 ppbV. After the introduction of zero air at 10:29 the HNO₃ measured value goes down to the 0.8 level after five minutes. After 35 minutes the HNO₃ level is down to 0.65 ppbV. Table 5 lists the data found on Figure 21 and calculated the theoretical denuder efficiency as a function of time. As a result of the long delay in the TECO analyzer, the efficiency measurement was recorded by taking the fifth minute point after measuring the concentration of the exit gas from the denuder.

If we had waited longer, as 35 minutes, we would still be at 0.65 ppbV or 1.4% of the input concentration. This memory effect clearly biased the efficiencies lower but represented on average less than 1.8% of the original target gas. To facilitate the measurements with the chemiluminescent analyzer to a point where the memory effect was reduced to 1% of the input concentration would have required 3 hours between point instead of the 12 minutes employed in the study. This would have reduced the resolution of the efficiency experiment and is clearly time wise, beyond the scope of the experiment.

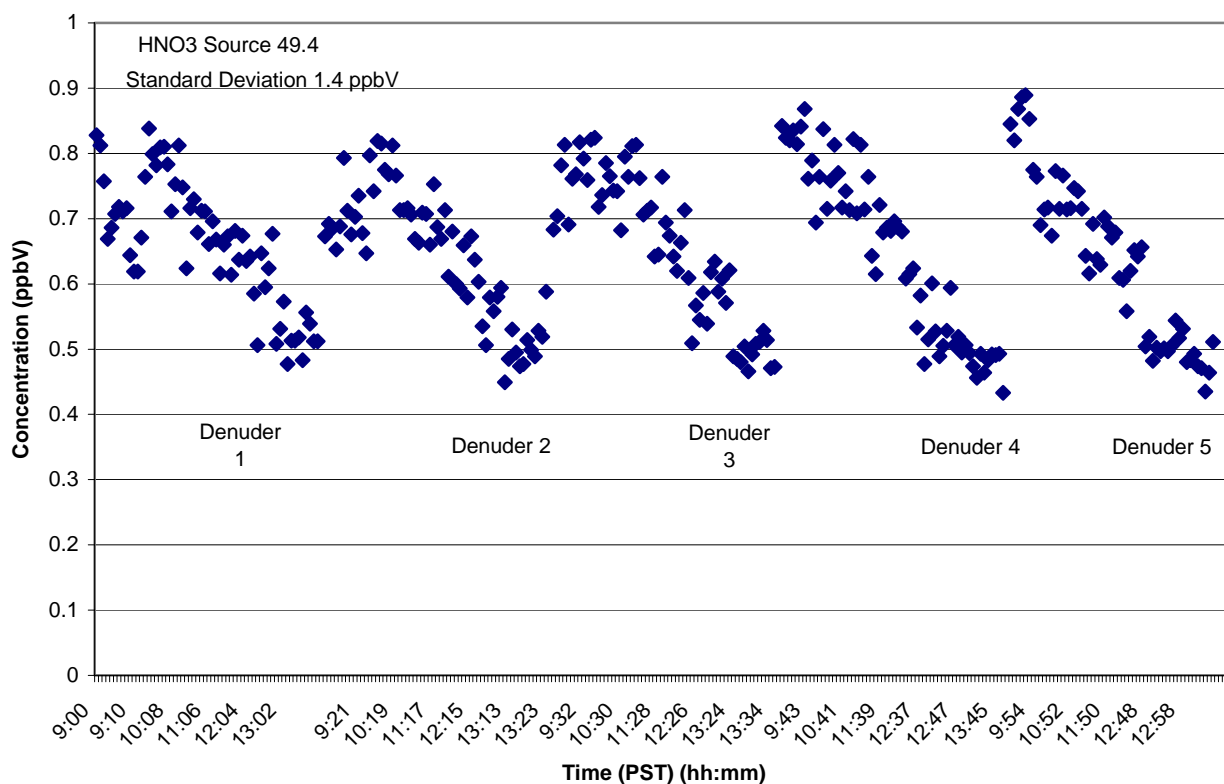

Figure 20. NO_y Measurements at the outlet of each denuder with NaCl coated filters added to scrub out any remaining nitric acid.

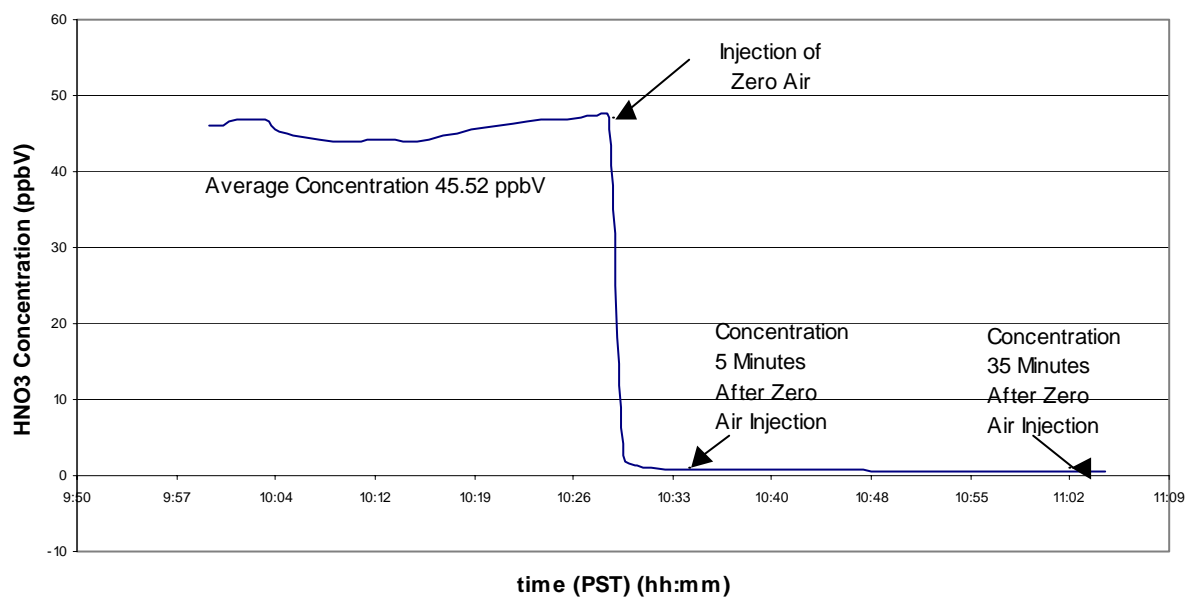

Figure 21. Response of the chemiluminescent NO_y analyzer to a change in average injection concentration from 45 ppbV of HNO₃ to zero air.

Table 5. Data showing the first ten minutes after injection of zero air into the Teco 42 NO_y converter.

Time	HNO₃ (ppbV)	% Of Input Concentration
10:28	47.31	103.9%
10:29	47.05	103.4%
10:30	2.72	6.0%
10:31	1.36	3.0%
10:32	1.00	2.2%
10:33	0.91	2.0%
10:34	0.81	1.8%
10:35	0.80	1.8%
10:36	0.76	1.7%
10:37	0.80	1.8%
10:38	0.78	1.7%

4. Summary and Conclusions

Table 6 summarizes the removal efficiency for both the filters and denuders by averaging all the test results for a given test gas and sampling medium. These averages provide a robust comparison of each sampling method and allows for a direct comparison between methods. Based on this table and the previously described data the following conclusions may be drawn:

Table 6. Summary of removal efficiencies.

Test Gas	Nylon Filter	Na ₂ CO ₃ Filter	NaCl Filter	Annular MgO	Annular Na ₂ CO ₃	Annular NaCl	Honeycomb MgO	Honeycomb Na ₂ CO ₃
HNO ₃	NA	NA	NA	85	68	60	81	83
NO ₂	14	3.8	7.0	5.1	4.6	4.2	3.0	1.7
HONO	13	76	39	85	82	21	81	76
PAN	3.8	3.5	NA	63	23	23	67	21

Nitric Acid

Both magnesium oxide and sodium carbonate coated denuders were generally efficient at removing nitric acid while the sodium chloride coated annular denuder was not. None of the tests showed over 95% efficiency, but this may have been due to residual nitric acid in the sampling lines of the test apparatus. While the removal efficiencies for both the annular and honeycomb denuders were similar, the honeycomb design possessed a much higher capacity. This was evidenced by breakthrough using the carbonate coated annular denuder but not with the carbonate coated honeycomb denuder when both were exposed to 50ppb of nitric acid over several days.

Nitrogen Dioxide

Except for the nylon filter and perhaps the sodium chloride-coated filter, none of the sampling media removed more than a few percent of nitrogen dioxide. Since NO₂ is often a dominant nitrogenous species, the use of this filter for selectively collecting nitrate may, based on our data, produce a positive bias.

Nitrous Acid

Both carbonate and magnesium oxide-coated denuders and carbonate coated filters effectively removed nitrous acid. Sodium chloride was less efficient and nylon was even less effect in removing this gas. Trace impurities of nitric acid (typically 3%) in the HONO no doubt contributed to the apparent removal efficiency.

Peroxyacetyl Nitrate

Magnesium oxide was more efficient in removing PAN compared with sodium carbonate or sodium chloride, which were about equally efficient. Neither nylon nor carbonate coated filters removed a significant amount of PAN.

5. Recommendations and Future Research

5.1 Recommendations

The recommendations based on this study depend on whether the objective is to measure nitric acid or total particulate nitrate.

Nitric Acid

When measuring nitric acid it is expected that denuders are renewed after each sampling period, presumably no longer than 24 hours. The denuder would be expected to be efficient and selective in removing this acid and easily extracted. While both annular and honeycomb denuders with either carbonate or magnesium oxide coating would be efficient, the carbonate coating is less efficient at removing PAN and is therefore preferred. In either case nitrous acid is also efficiently collected and, therefore, the results will be biased high since the nitrite (and also PAN) collected will be readily oxidized to nitrate by ambient concentrations of ozone (Perrino et al., 1990). It should be noted that the honeycomb denuder holders were constructed of stainless steel, and some of the removal efficiency for nitric acid in particular may be due to these surfaces. If this denuder is to be used to measure nitric acid (as opposed to removing it for measuring particulate nitrate), the recovery of nitric acid by the denuder itself should be evaluated. Sodium chloride-coated annular denuders were found to not be sufficiently efficient in removing nitric acid under these conditions.

If measuring particulate nitrate is desired using the same denuder to quantify nitric acid as the gaseous stripper, the carbonate-coated filter is recommended over the nylon. Although the carbonate-coated filter efficiently removes nitrous acid, this already has been removed by the denuder. Particulate nitrate collected on nylon filters will likely be biased high due to the collection of nitrogen dioxide.

Particulate Nitrate

When measuring particulate nitrate it is only necessary to remove the nitric acid and allow particles to pass through. In this case the denuder does not need to be changed regularly and preferably it is only renewed for cleaning purposes. Selectivity is not necessary, and depending on the filter medium used, not even necessarily desirable. A denuder that strips all of the nitrogenous gases would allow any filter that quantitatively traps ammonium nitrate to be used to collect particulate nitrate. Based on two weeks of exposure to over 50ppb of nitric acid, the annular denuder coated with magnesium oxide and the honeycomb with either coating can be used for at least 16,800 ppb-hours. From past measurements in Claremont, CA, the highest daily average we observed using a tunable diode laser absorption spectrometer was 12ppb. This concentration corresponds to two months of sampling under these conditions. Since this was the highest daily concentration observed in the peak smog season in a location that likely has the highest nitric acid concentrations in the United States, this denuder should be capable of being effective for significantly longer periods for other parts of the country. The magnesium oxide coating is likely to have greater capacity than the carbonate. Because of this potential and its ability to remove more PAN than carbonate, this coating is recommended for this application.

The honeycomb design is also likely to have more capacity, but this would require further evaluation

With a magnesium oxide denuder to strip nitric acid, the best choice of a filter to collect nitrate would be the carbonate coated since it is less likely to collect NO_2 than nylon filters. Sodium chloride coated filters may also be suitable, but we did not have results for this substrate on either nitric acid or PAN.

5.2 Future Research

Previous research has shown that denuders coated with sodium chloride, sodium carbonate and magnesium oxide are all nearly 100% efficient in removing nitric acid from ambient air (Febo et al., 1990). Future research should focus testing removal efficiency using spiked ambient air. Since ambient air will contain a variety of nitrogenous species, the use of a chemiluminescent NO_x analyzer for determining concentration before and after a test substrate would clearly not be useful. More selective methods should be used, such as tunable diode laser absorption spectrometers (TDLAS).

For nitric acid measurement both magnesium oxide and sodium carbonate-coated denuders will bias the results high. Sodium chloride coating appears to be, as reported previously (Perrino et al., 1990), much more selective in removing nitric acid, having very little affinity for nitrous acid and slightly more for PAN. In our studies the nitric acid removal efficiency of the sodium chloride-coated annular denuder was lower than the other substrates. The desirable selectivity of the NaCl coating also may result in an apparent lower removal efficiency compared with other coating substrates if significant amounts of other nitrogenous species are present in the nitric acid test gas (since the chemiluminescent analyzer will also respond to them). Although we have shown that our nitric acid source appears to contain little contamination, using a TDLAS to test efficiency would be a more quantitative approach.

Since the honeycomb denuder design appeared to possess greater efficiency and capacity, we recommend evaluating the use of sodium chloride coatings in removing nitric acid. As previously mentioned, the effect of the stainless steel denuder holder must first be evaluated. Evaluation of the lower capacity annular denuder showed a peculiar initial loss in denuder efficiency removal efficiency followed by stabilization. Additional or substitute wetting agent may result in maintaining high removal efficiency. Using longer annular denuder sections may also increase the removal efficiency.

Both nylon and sodium chloride-coated filters appeared to collect small amounts of NO_2 , HONO, and PAN. Further evaluation is needed to confirm the significance of this, preferably using spiked ambient air. The use of a TDLAS as a detector would provide a quantitative result since it would be more selective and have less sample hangup than a chemiluminescent analyzer. Carbonate-coated filters showed a high removal efficiency for HONO and, therefore, should be avoided for collecting particulate nitrate without an effective nitric acid denuder, as the results are likely to be biased high. Additional testing is recommended to determine the efficiency of sodium chloride coated filters for collecting nitric acid. A more rigorous analysis of impurities and sample line hold up (if a chemiluminescent analyzer was used for measurements) would provide a more accurate removal efficiency determination.

Analysis of filter extracts by a method quantifying total nitrogen would improve the mass balance when removal is compared with adsorption. Although the NO_x analyzer showed low removal efficiencies of PAN by the various filters, a significant amount of nitrate was found on these filters after sampling. Further evaluation is needed to determine the fate of PAN on these filters.

References

- Allegrini, I.; Febo, A.; Perrino, C.; and Masia, P. (1994) Measurement of atmospheric nitric acid in gas phase and nitrate in particulate matter by means of annular denuders. *Intern. J. Anal. Chem.* 54, 183-201.
- Carter, W.P.L.; Luo, D.; Malkina, I.L.; and Fitz, D. (1995) "The University of California, Riverside Environmental Chamber Data Base for Evaluating Oxidant Mechanisms. Indoor Chamber Experiments through 1993," Report submitted to the U.S. Environmental Protection Agency, EPA/AREAL, Research Triangle Park, NC, March 20.
- Febo, A.; Perrino, C.; Gherardi, M.; Sparapani, R. Evaluation of a High-Purity and High-Stability Continuous Generation System for Nitrous Acid; *Environ. Sci. Technol.* **1995**, 29, 2390-2395.
- Fitz., D.R.; Pankratz, D.V.; Bumiller, K.; Smith M. (2001) Measurement of NO₂ and PAN by Gas Chromatography with Luminol Detection. To be submitted to *Atmospheric Environment*.
- Holdren, M.W.; Spicer, C.W. Field Compatible Calibration Procedure for Peroxyacetyl Nitrate. *Environ. Sci. Technol.* **1984**, 18:113-116.
- Perrino, C.; DeSantis, F.; and Febo, A. (1990) Criteria for the choice of a denuder sampling technique devoted to the measurement of atmospheric nitrous and nitric acid. *Atmos. Environ.* 24A, 617-626.
- Winer, A.M; Peters, J.W.; Smith, J.P.; and Pitts, J.N., Jr. (1974) Response of commercial chemiluminescent NO-NO_x analyzers to other nitrogen-containing compounds. *Environ. Sci. Technol.* 8, 1118-1121

TECHNICAL REPORT DATA

(Please read Instructions on reverse before completing)

1. REPORT NO. EPA-454/R-02-011	2.	3. RECIPIENT'S ACCESSION NO.
4. TITLE AND SUBTITLE Evaluation of Diffusion Denuder Coatings for Removing Acid Gases from Ambient Air	5. REPORT DATE April 2002	6. PERFORMING ORGANIZATION CODE
	8. PERFORMING ORGANIZATION REPORT NO.	
7. AUTHOR(S) Dennis R.Fitz	9. PERFORMING ORGANIZATION NAME AND ADDRESS College of Engineering-Center for Environmental Research and Technology University of California, Riverside, CA 92521	
12. SPONSORING AGENCY NAME AND ADDRESS Office of Air Quality Planning and Standards U.S. Environmental Protection Agency Research Triangle Park, NC 27711	10. PROGRAM ELEMENT NO.	
	11. CONTRACT/GRANT NO. Assistance agreement # GX82866301	
13. TYPE OF REPORT AND PERIOD COVERED Final, life of project 1 yr.	14. SPONSORING AGENCY CODE EPA/200/04	
	15. SUPPLEMENTARY NOTES This report represents an initial study of the efficiency and capacity of denuders used in EPA's National PM2.5 Chemical Speciation Trends Network. Additional work is needed to clarify uncertainty and allow for additional quantitative results.	
16. ABSTRACT This study evaluated the efficiency and capacity of several commonly used denuder styles and coatings, with an emphasis on denuders used in EPA's National PM2.5 Chemical Speciation Trends Network (STN). Denuder styles included annular and honeycomb denuders coated with either magnesium oxide, sodium carbonate, or sodium chloride. Collection filters included nylon or filters impregnated with sodium carbonate (Na₂CO₃) or sodium chloride (NaCl). Denuder coatings and reactive filters were tested for their removal efficiency of nitric acid, nitrogen dioxide (NO₂), nitrous acid (HNO₂), and peroxyacetyl nitrate (PAN). Most important to the STN is the ability to collect ammonium nitrate with minimal bias and interference from other nitrogen gases, such as, NO₂, HNO₂, and PAN. Results indicated that MgO denuders were most efficient for removing HNO₃, HNO₂, and PAN with the largest capacity and that honeycomb denuders had larger capacity than annular denuders. Nylon filters adsorbed slightly more NO₂ than those coated with Na₂CO₃ or NaCl, but both of the latter adsorbed significantly larger amounts of HNO₂. Results suggest that a MgO coated honeycomb or annular denuder followed by a Na₂CO₃ or nylon filter will minimize interferences for the collection of ammonium nitrate. The choice between Na₂CO₃ and nylon may be based on expected concentrations of HNO₂, with nylon having a lower affinity for HNO₂ than Na₂CO₃.		
17. KEY WORDS AND DOCUMENT ANALYSIS		
a. DESCRIPTORS	b. IDENTIFIERS/OPEN ENDED TERMS	c. COSATI Field/Group
nitric acid, denuders, nylon filters, impregnated filters, sodium carbonate, ammonium nitrate	Air Pollution control	
18. DISTRIBUTION STATEMENT Release Unlimited	19. SECURITY CLASS (<i>Report</i>) Unclassified	21. NO. OF PAGES 32 + appendices
	20. SECURITY CLASS (<i>Page</i>) Unclassified	22. PRICE

EPA Denuder Efficiency Evaluation Denuder 1 Experiment 1 (Low Humidity, High HNO₃ Concentration)

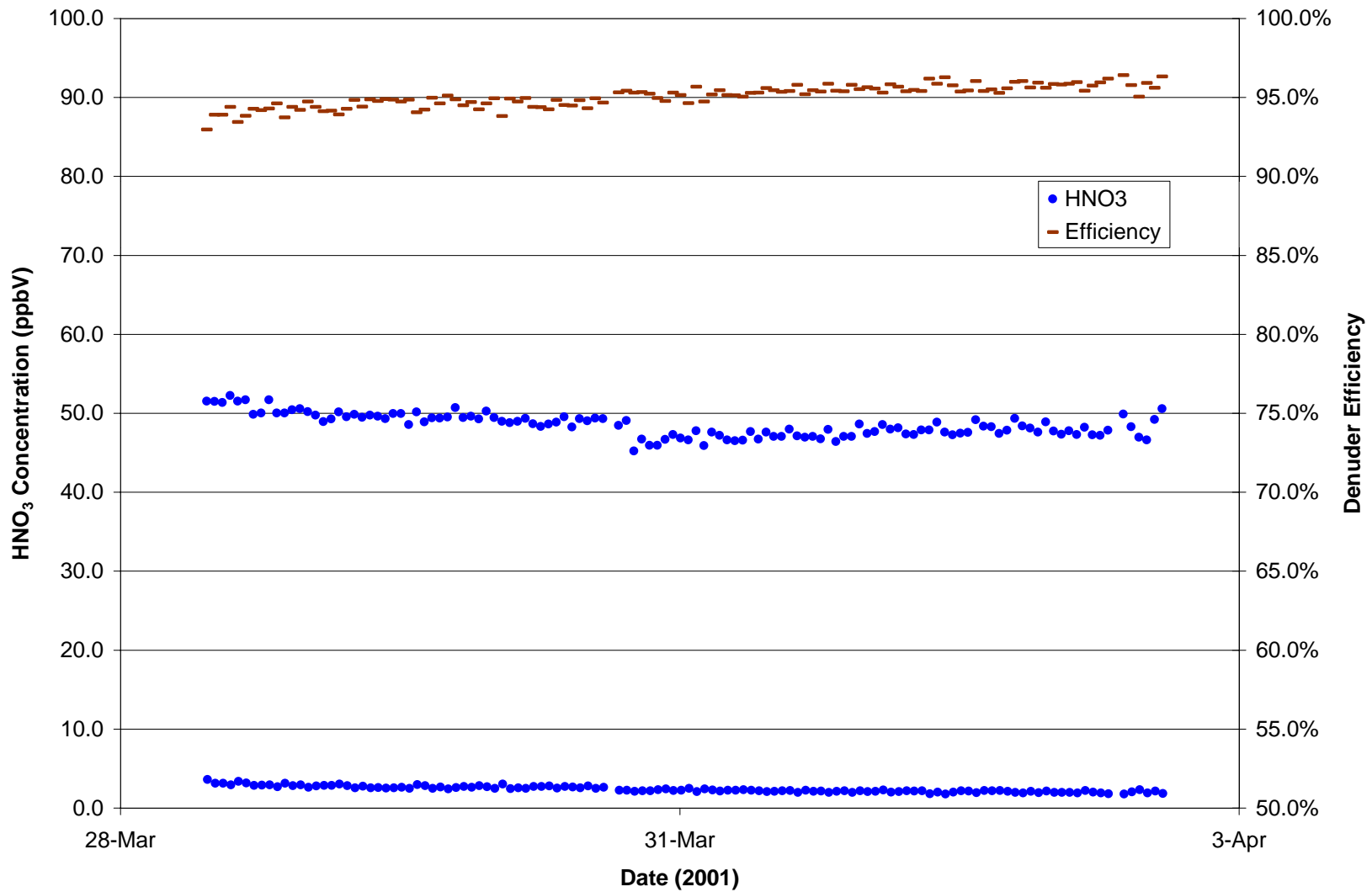

EPA Denuder Efficiency Evaluation Denuder 2 Experiment 1 (Low Humidity, High HNO₃ Concentration)

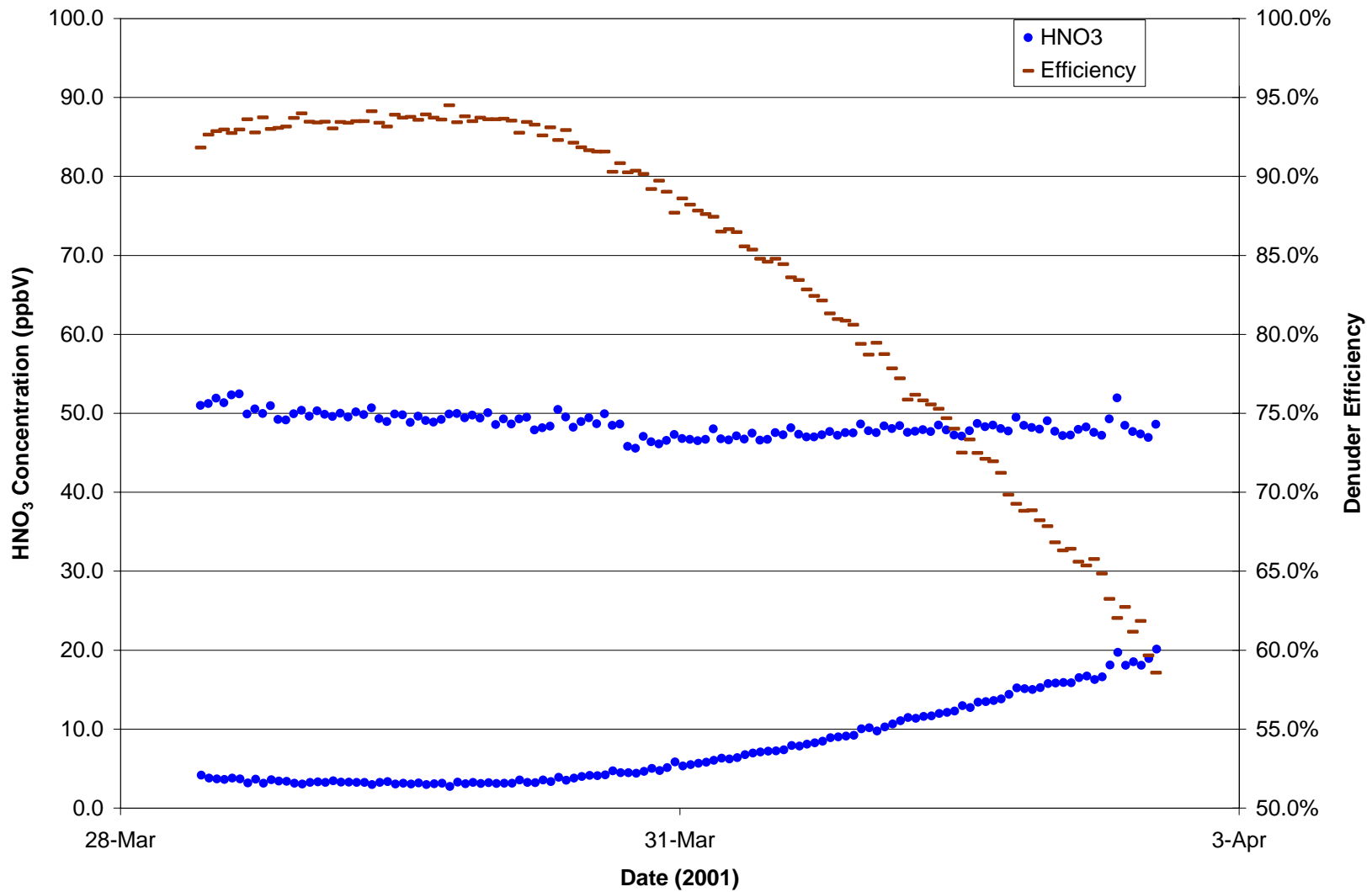

EPA Denuder Efficiency Evaluation Denuder 3 Experiment 1 (Low Humidity, High HNO3 Concentration)

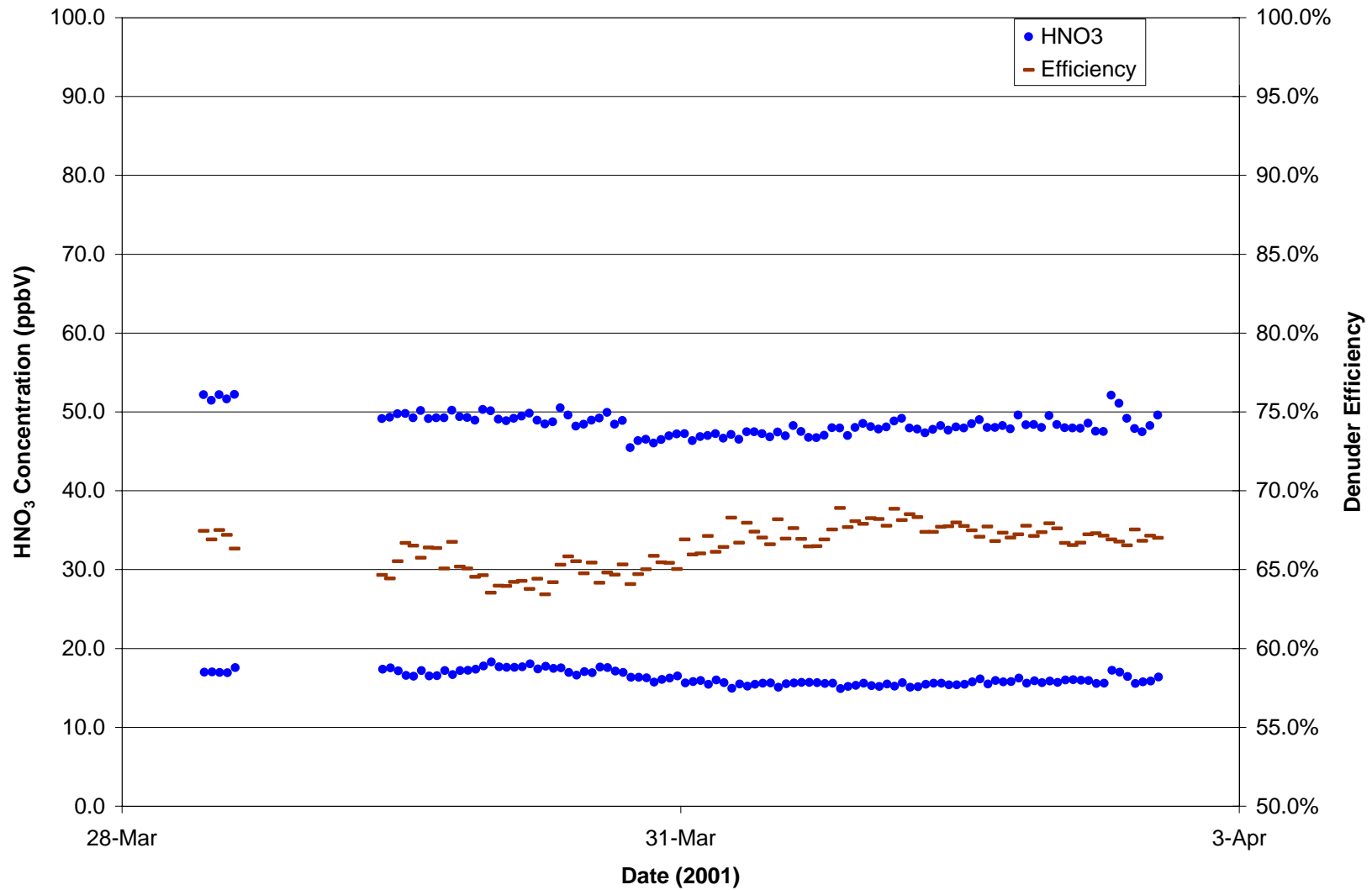

EPA Denuder Efficiency Evaluation Denuder 4 Experiment 1 (Low Humidity, High HNO₃ Concentration)

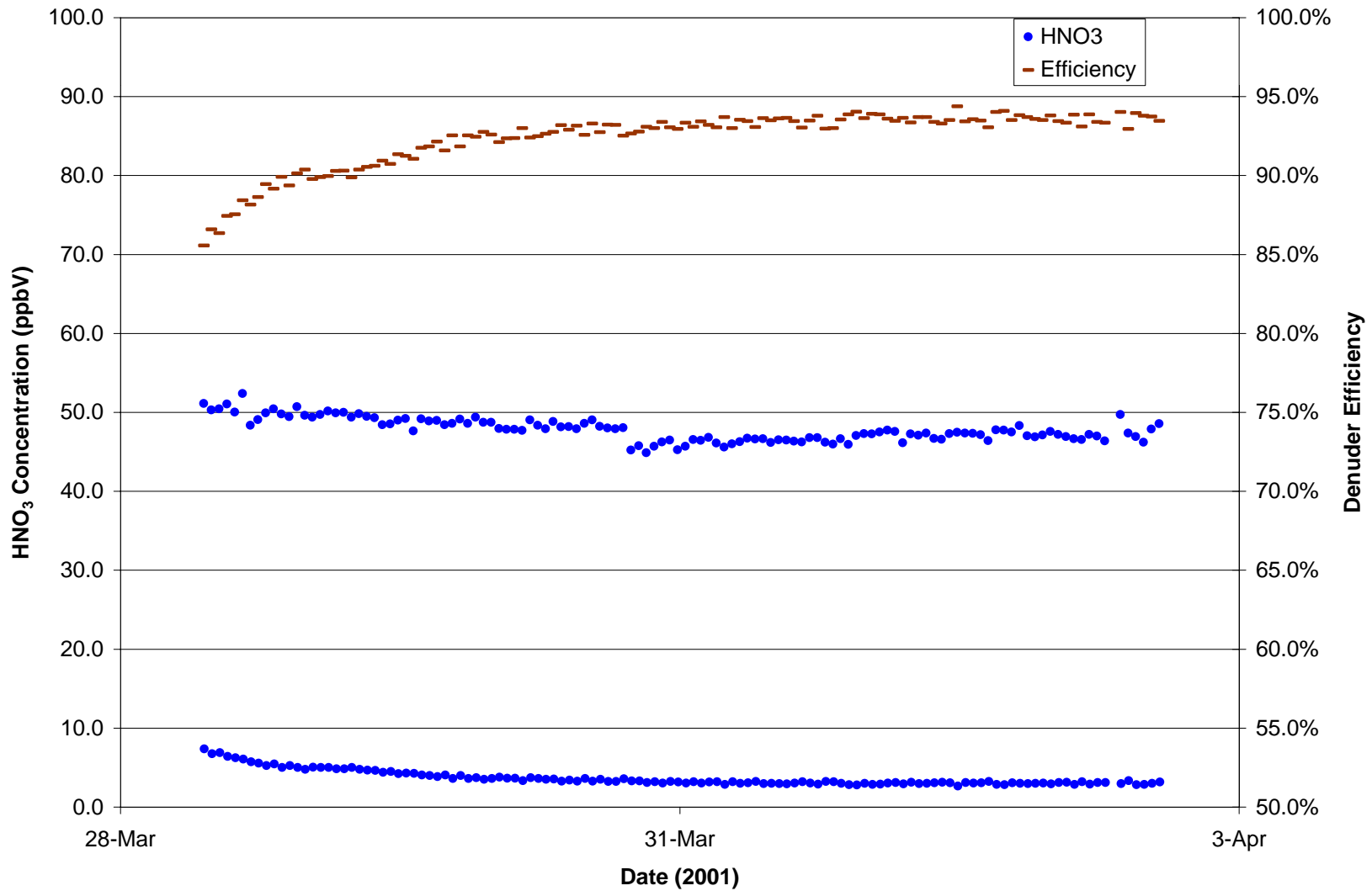

EPA Denuder Efficiency Evaluation Denuder 5 Experiment 1 (Low Humidity, High HNO₃ Concentration)

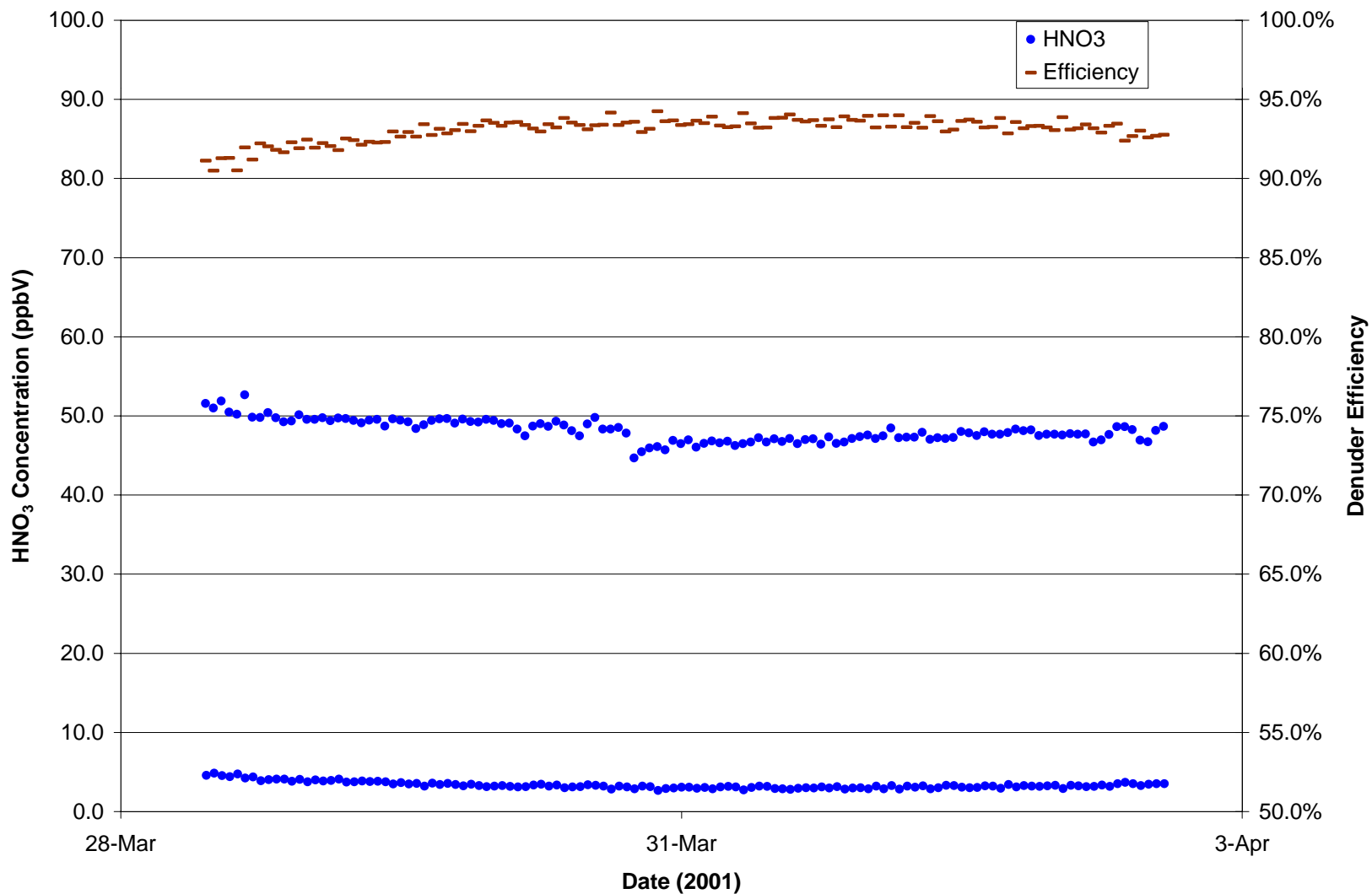

EPA Denuder Efficiency Evaluation Denuder 1
Experiment 2 (Low Humidity, High HNO3 Concentration) Using Spent Denuder

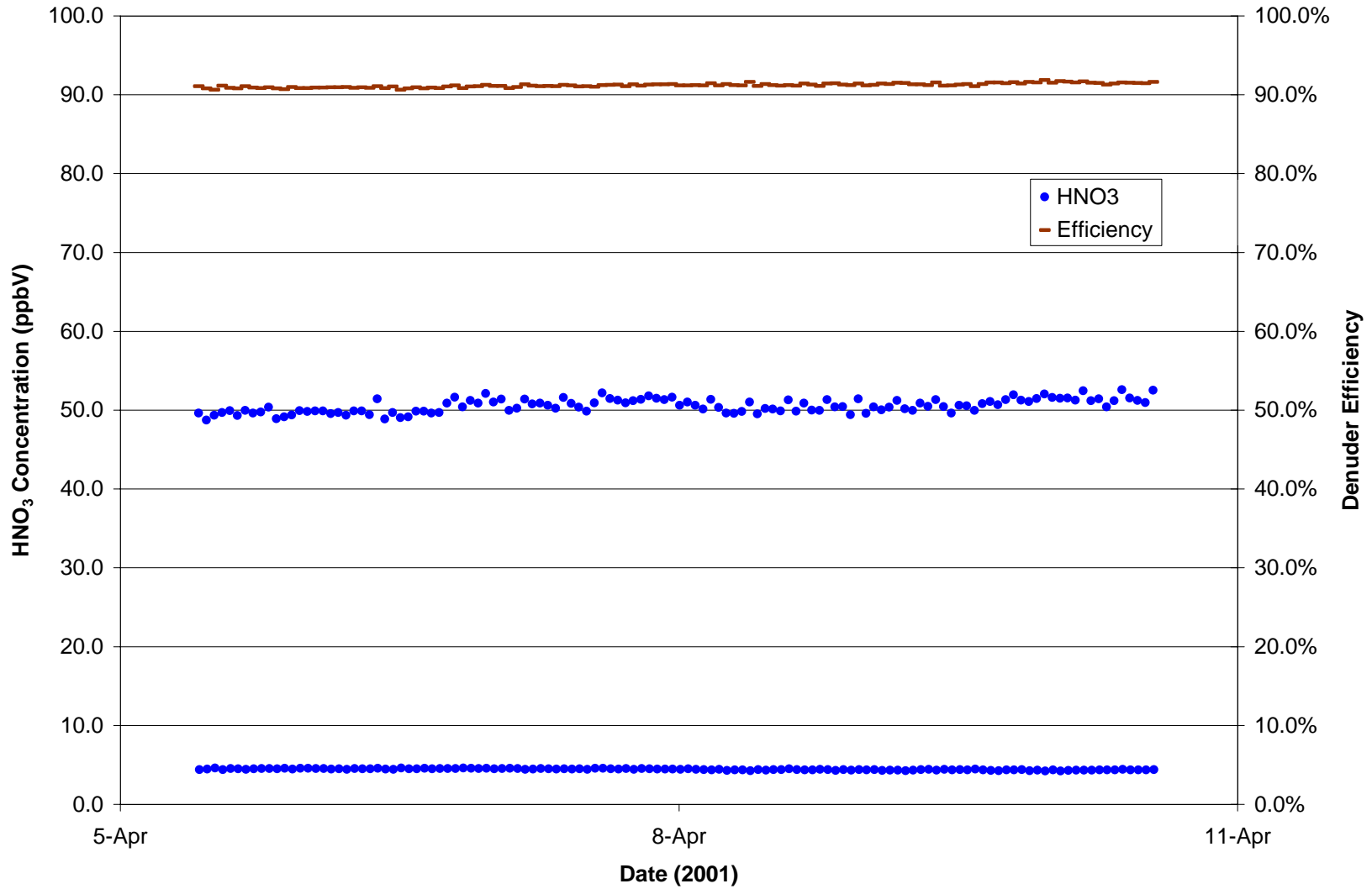

EPA Denuder Efficiency Evaluation Denuder 2
Experiment 2 (Low Humidity, High HNO₃ Concentration) Using Spent Denuder

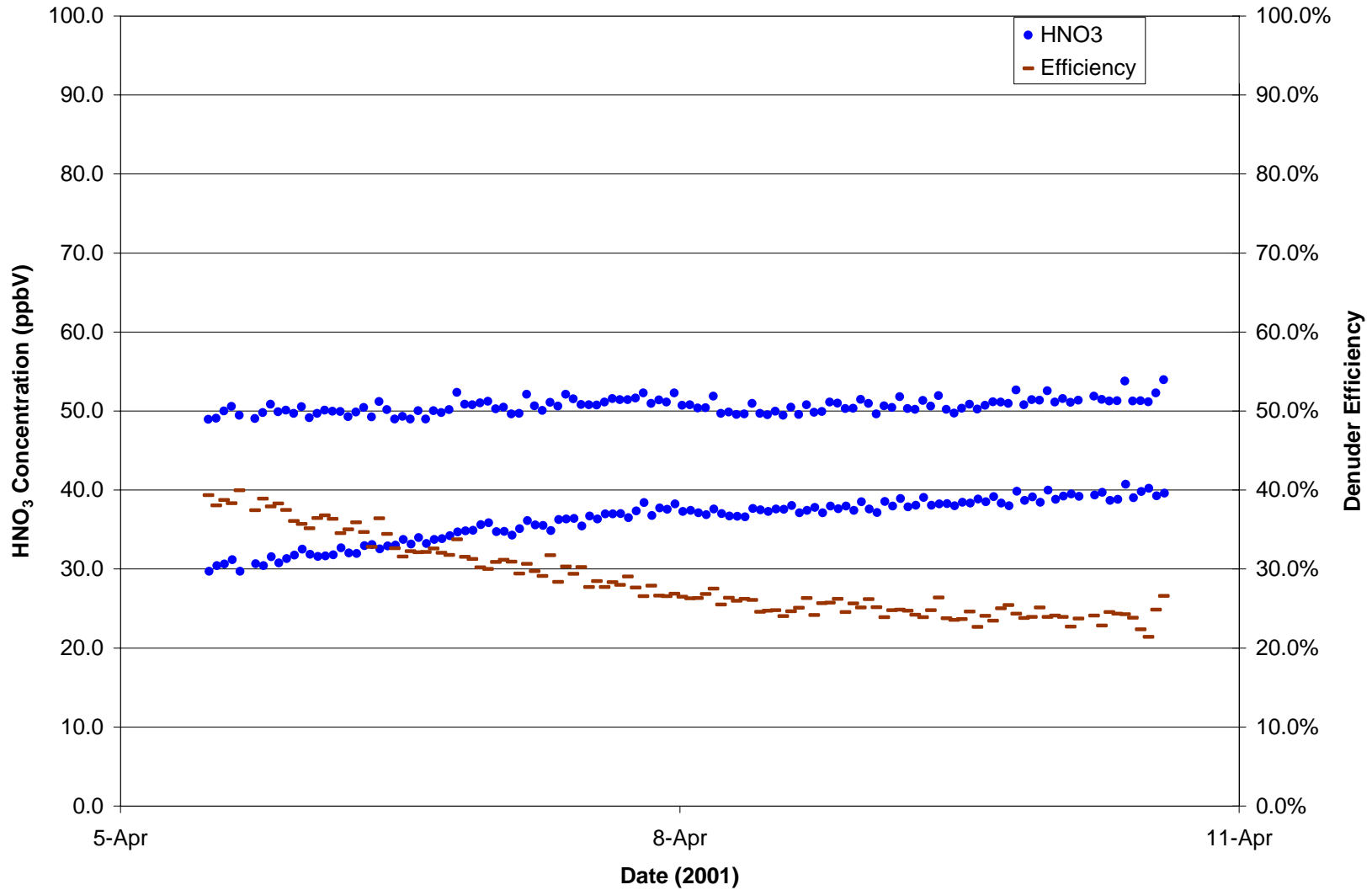

EPA Denuder Efficiency Evaluation Denuder 3 Experiment 2 (Low Humidity, High HNO₃ Concentration) Using Spent Denuder

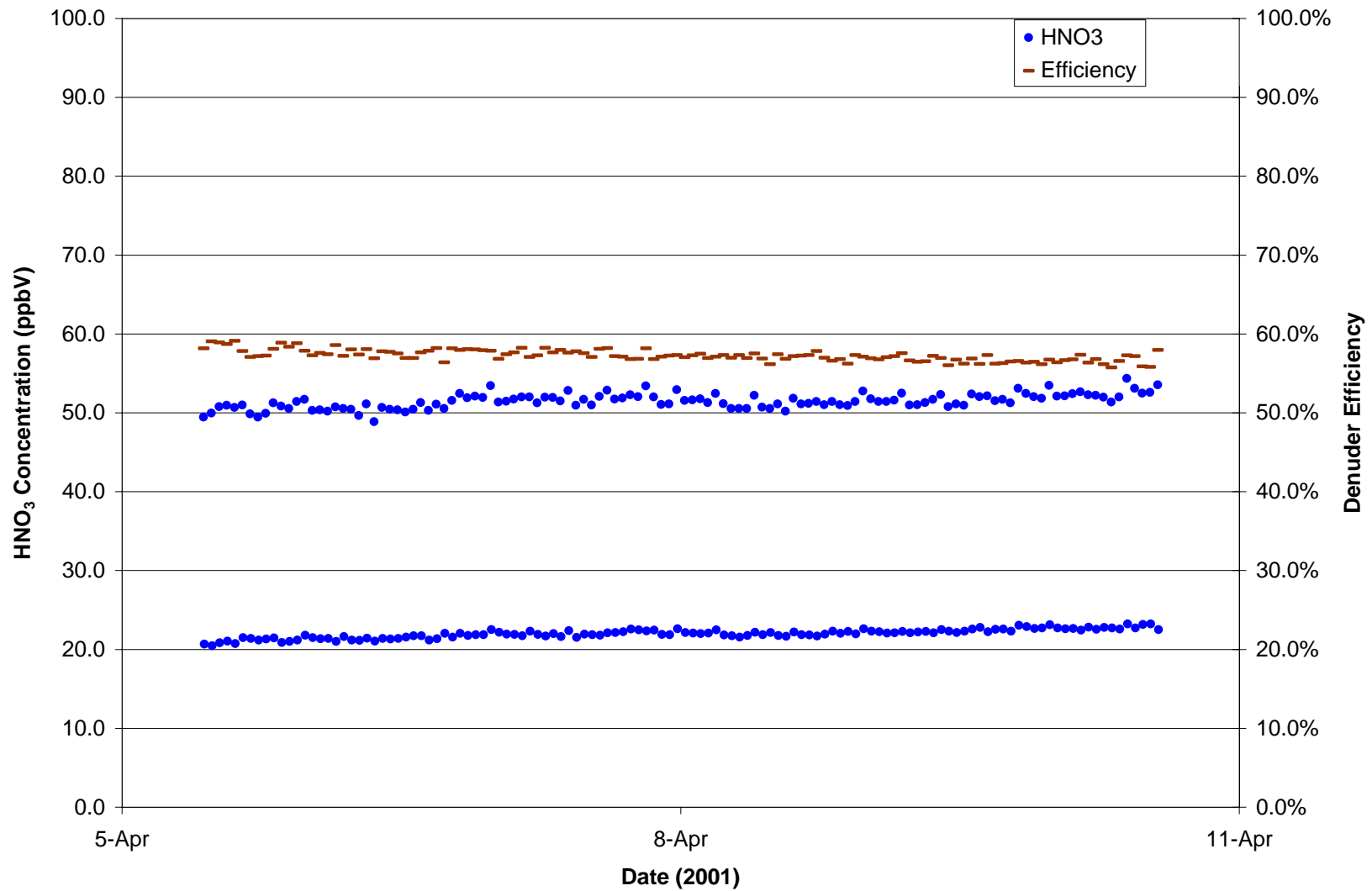

EPA Denuder Efficiency Evaluation Denuder 4
Experiment 2 (Low Humidity, High HNO₃ Concentration) Using Spent Denuder

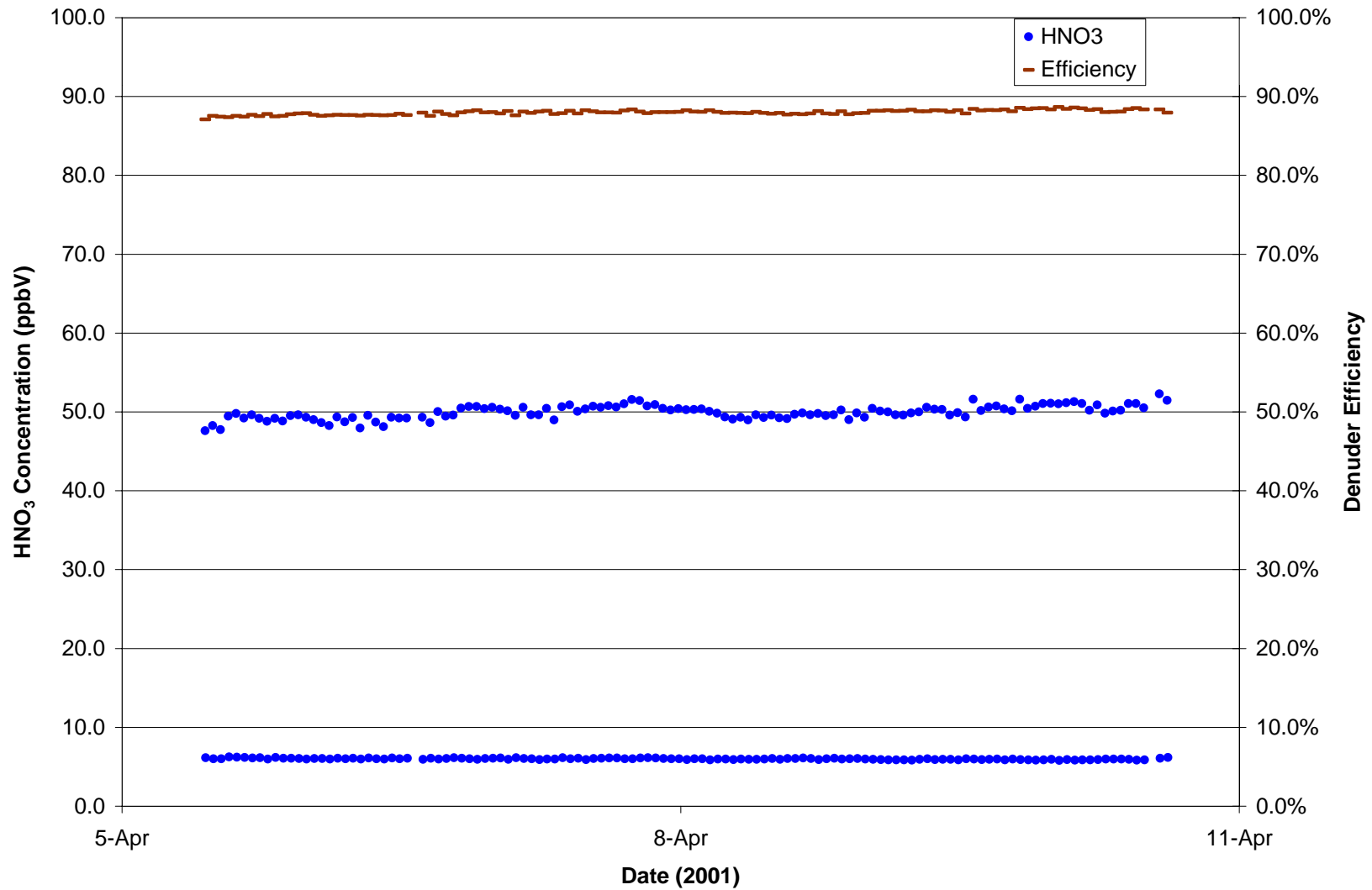

EPA Denuder Efficiency Evaluation Denuder 5 Experiment 2 (Low Humidity, High HNO₃ Concentration) Using Spent Denuder

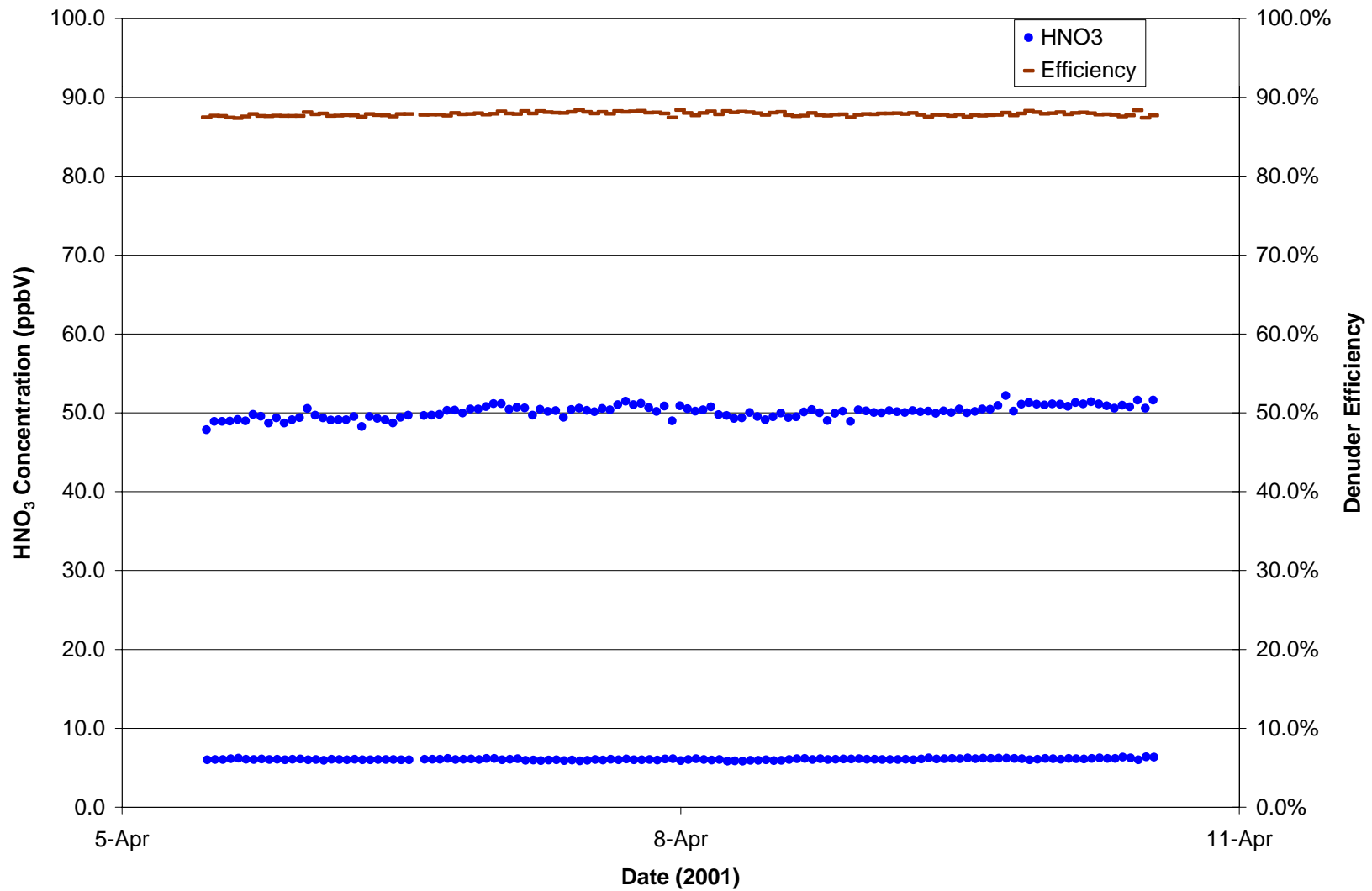

EPA Denuder Efficiency Evaluation Denuder 1
Experiment 3 (Repeat of Experiment 1, Low Humidity, High HNO₃ Concentration)

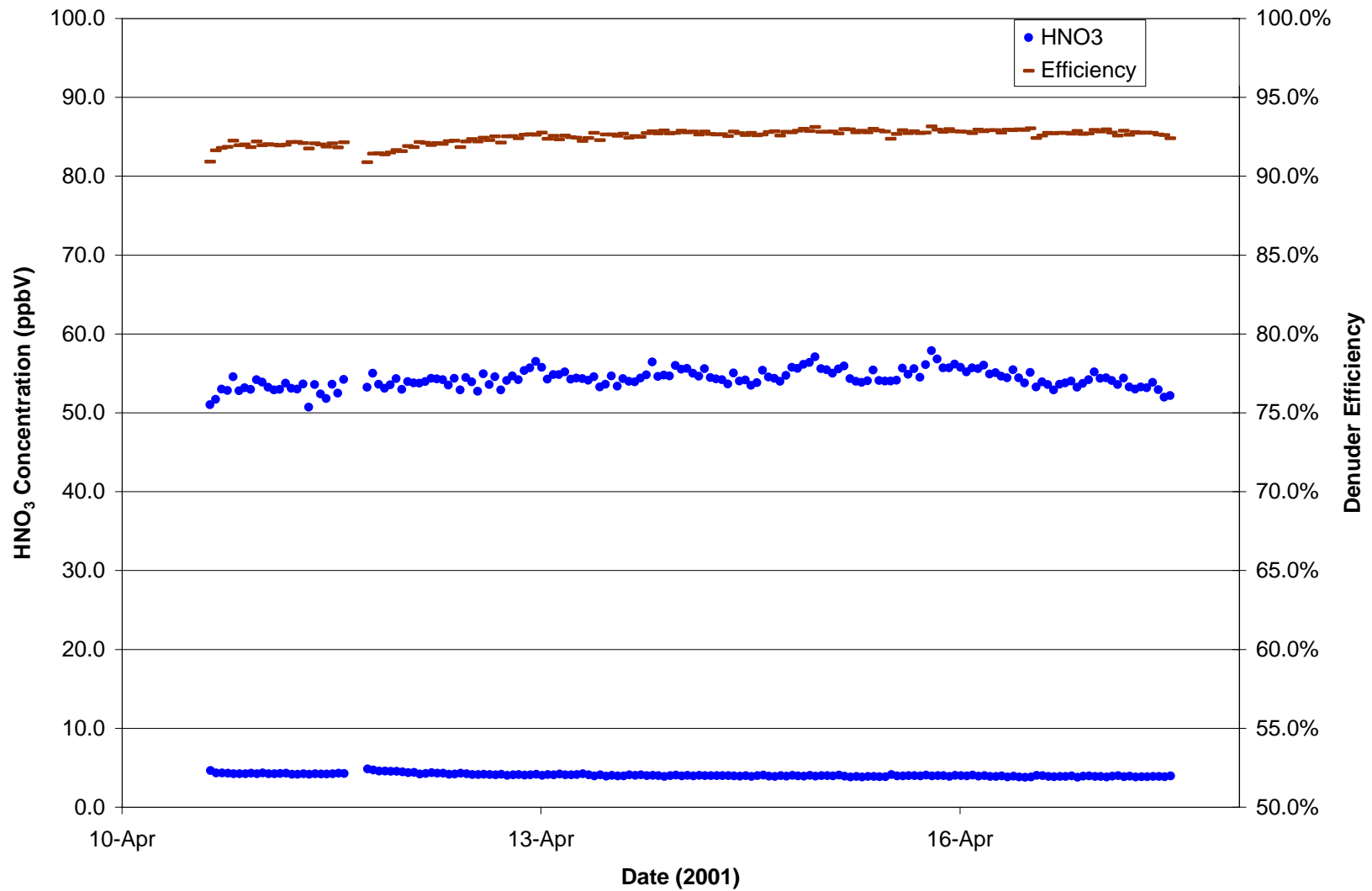

EPA Denuder Efficiency Evaluation Denuder 4
Experiment 3 (Repeat of Experiment 1, Low Humidity, High HNO3 Concentration)

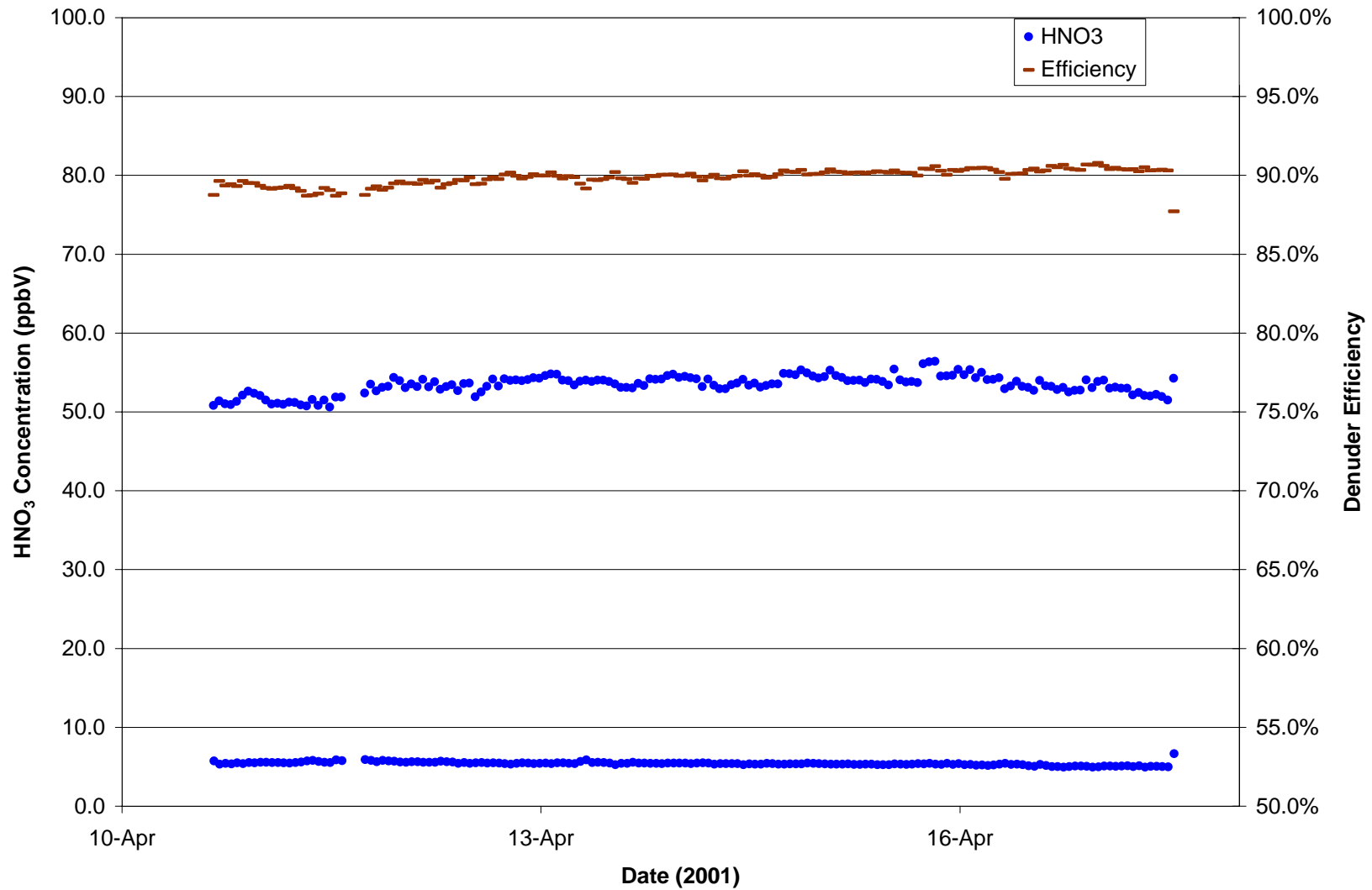

EPA Denuder Efficiency Evaluation Denuder 3
Experiment 3 (Repeat of Experiment 1, Low Humidity, High HNO3 Concentration)

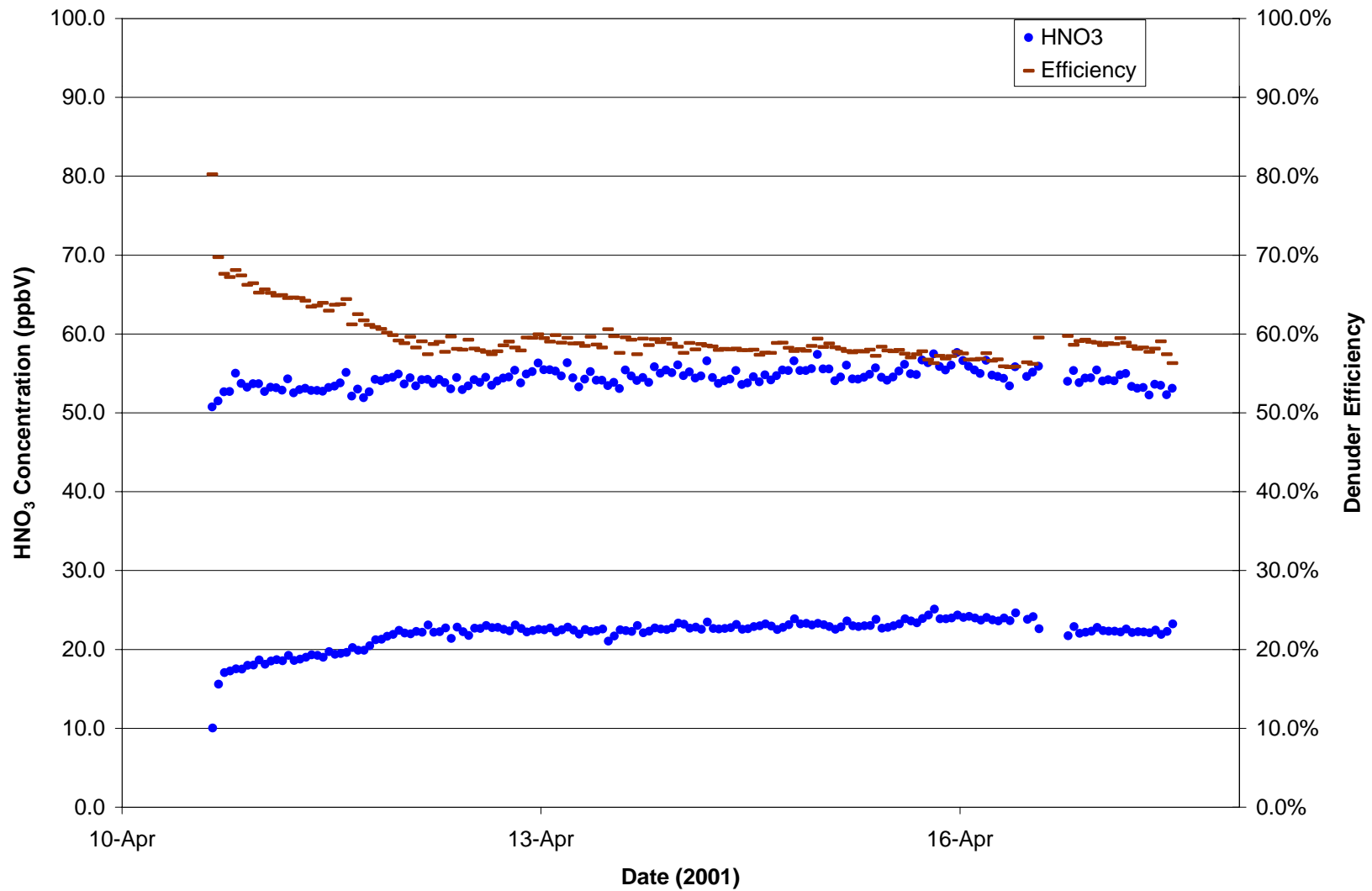

EPA Denuder Efficiency Evaluation Denuder 2
Experiment 3 (Repeat of Experiment 1, Low Humidity, High HNO₃ Concentration)

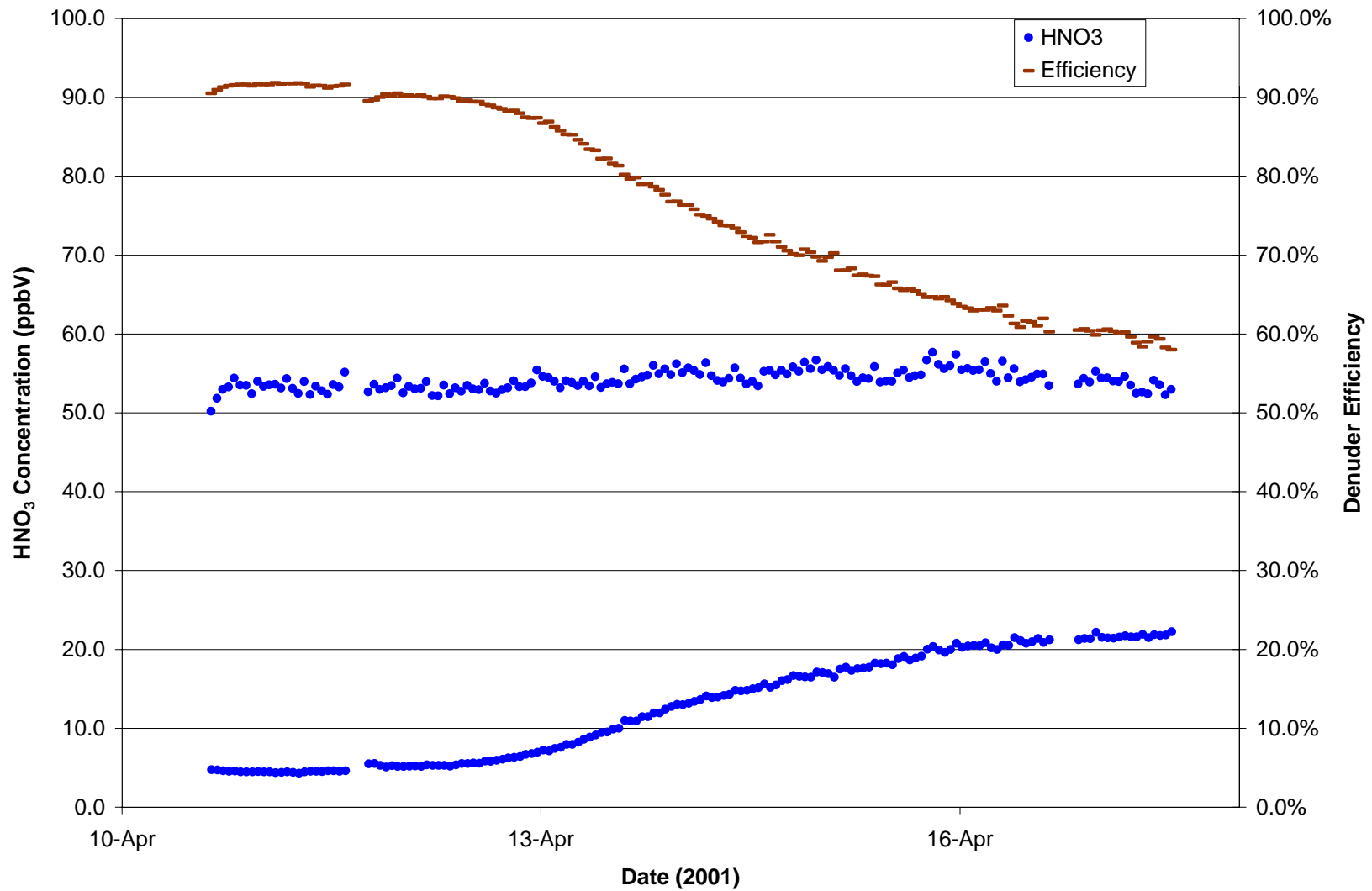

EPA Denuder Efficiency Evaluation Denuder 5
Experiment 3 (Repeat of Experiment 1, Low Humidity, High HNO₃ Concentration)

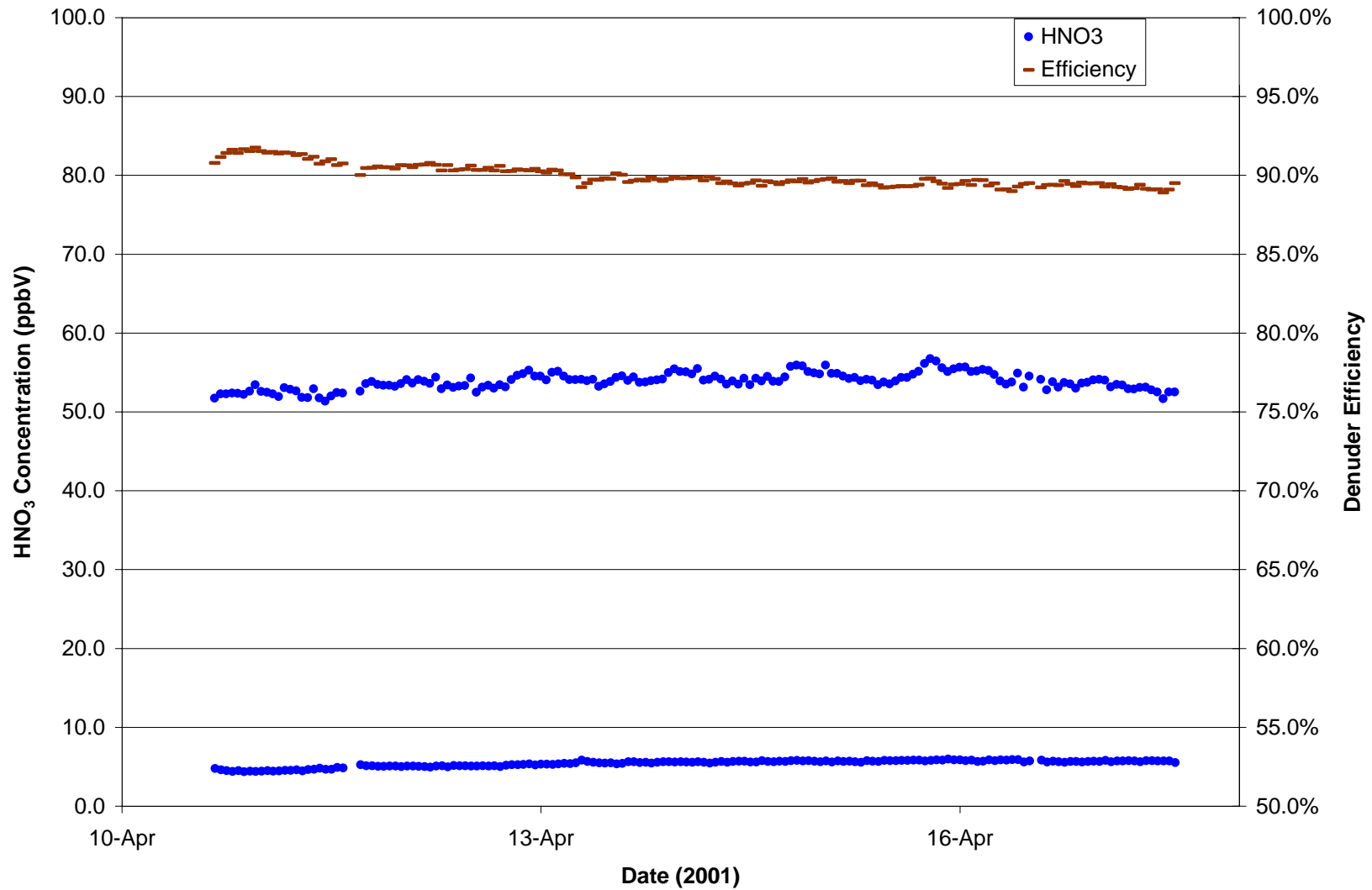

EPA Denuder Efficiency Evaluation Denuder 1 Experiment 4 (Low Humidity, Low HNO₃ Concentration)

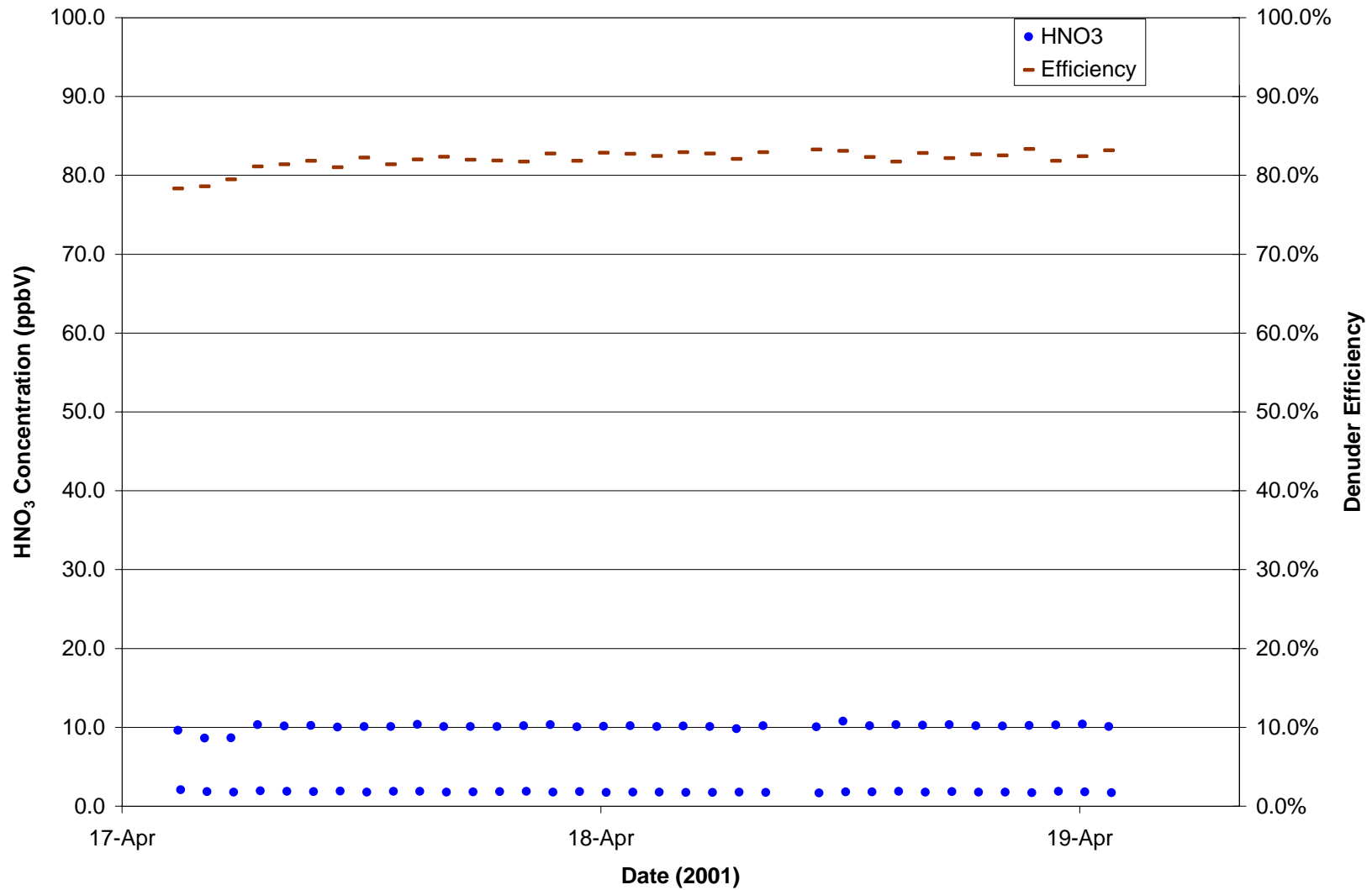

EPA Denuder Efficiency Evaluation Denuder 4 Experiment 4 (Low Humidity, Low HNO₃ Concentration)

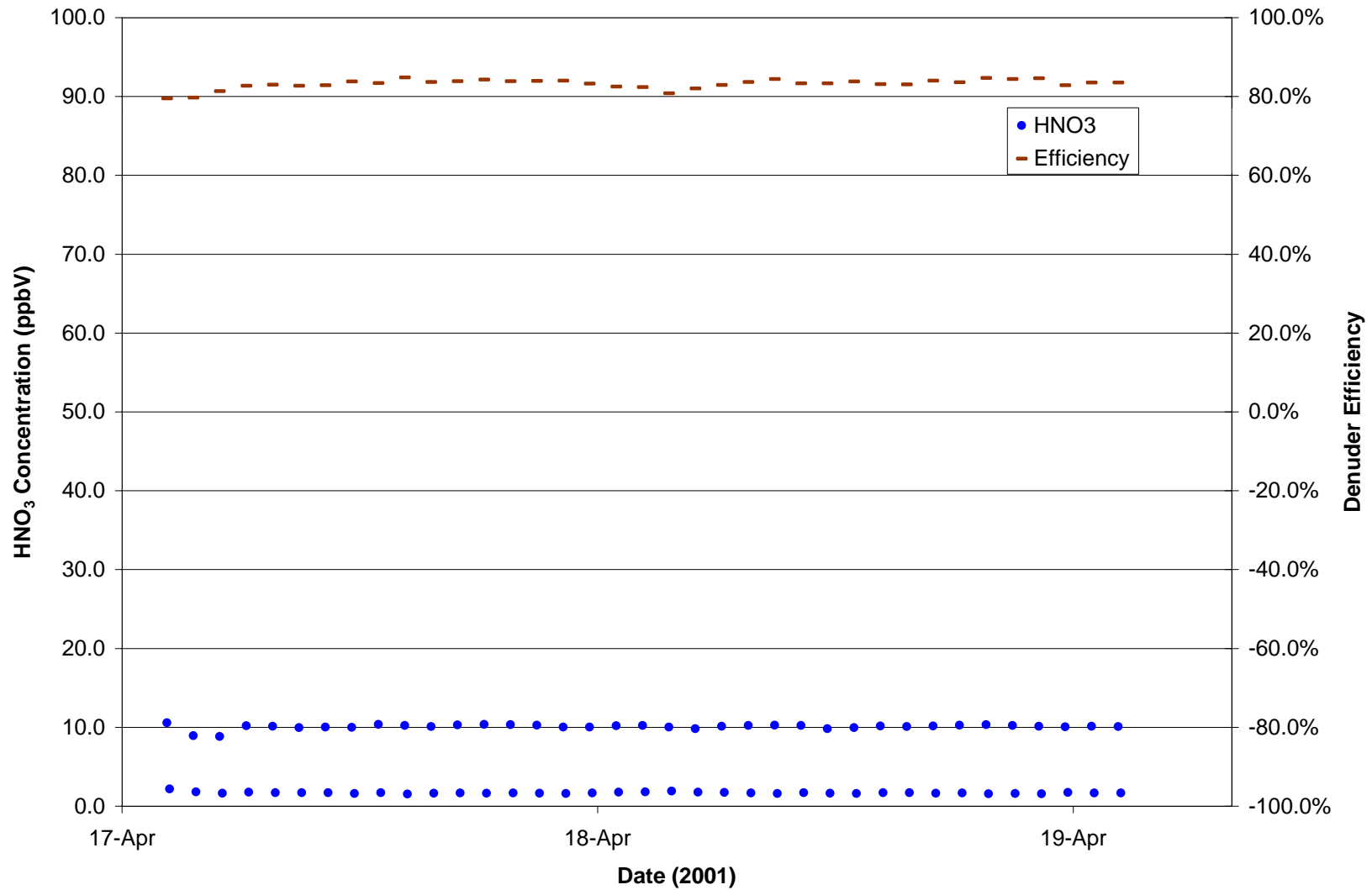

EPA Denuder Efficiency Evaluation Denuder 3 Experiment 4 (Low Humidity, Low HNO3 Concentration)

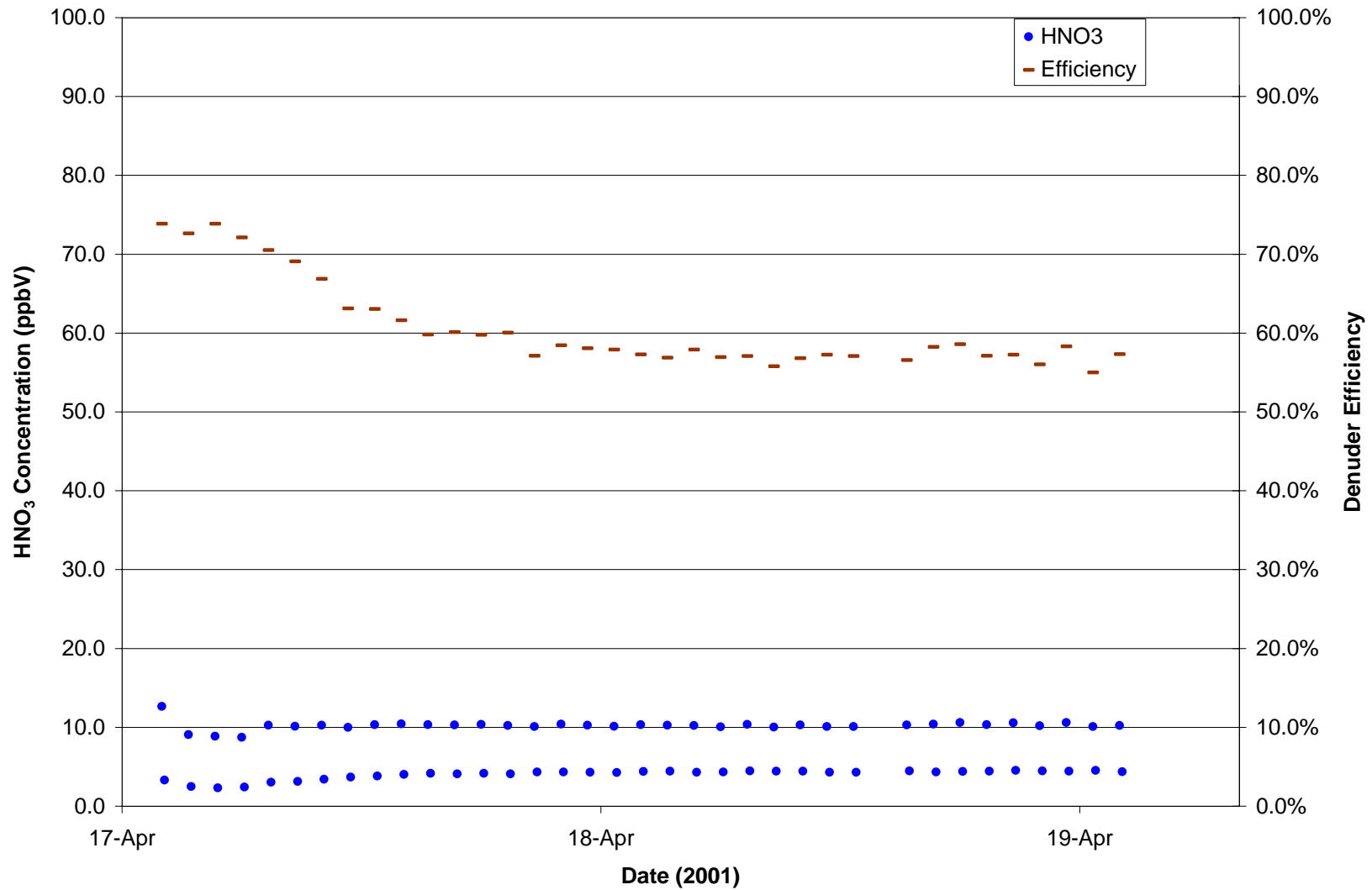

EPA Denuder Efficiency Evaluation Denuder 2 Experiment 4 (Low Humidity, Low HNO3 Concentration)

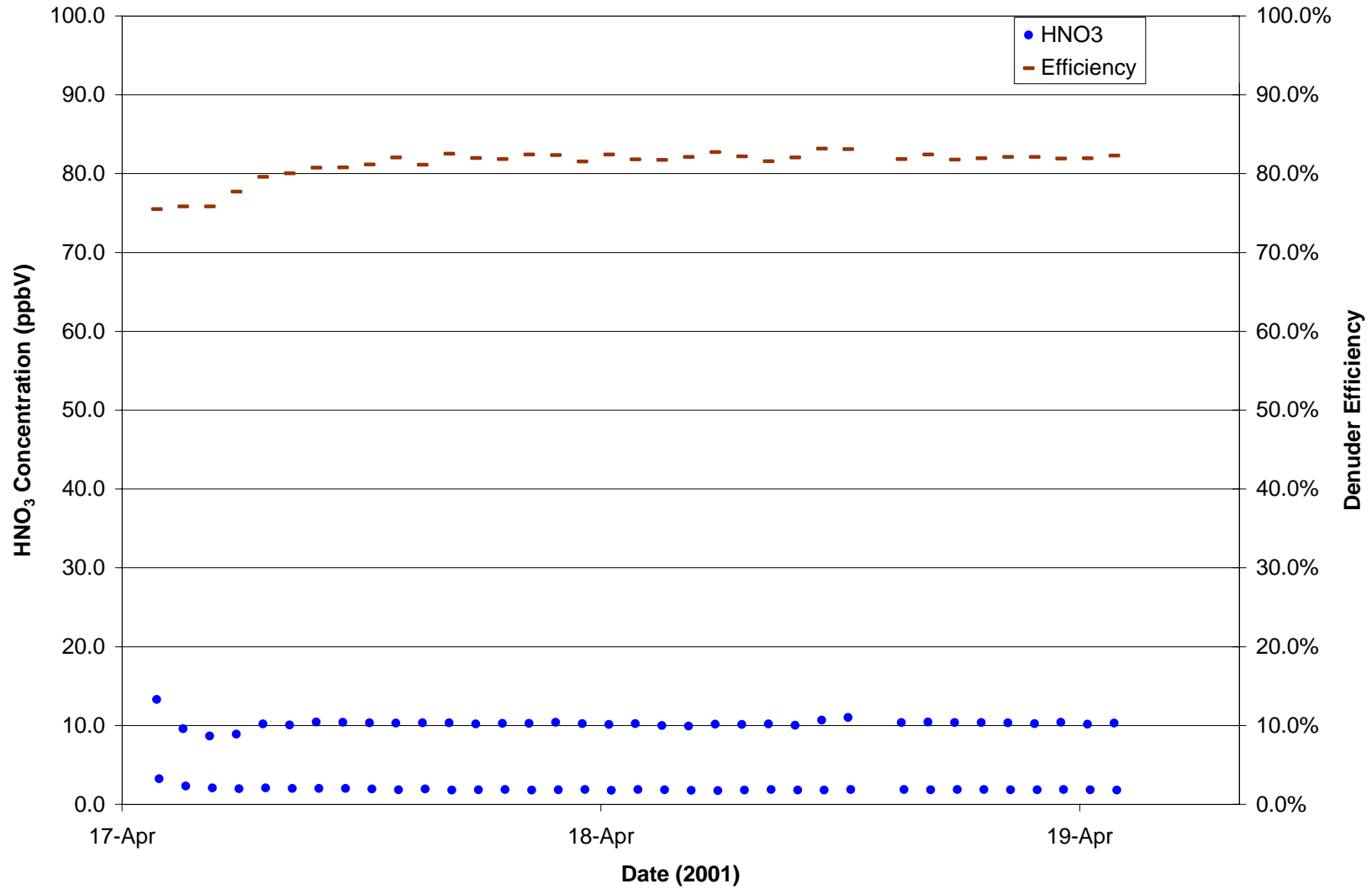

EPA Denuder Efficiency Evaluation Denuder 5
Experiment 4 (Low Humidity, Low HNO3 Concentration)

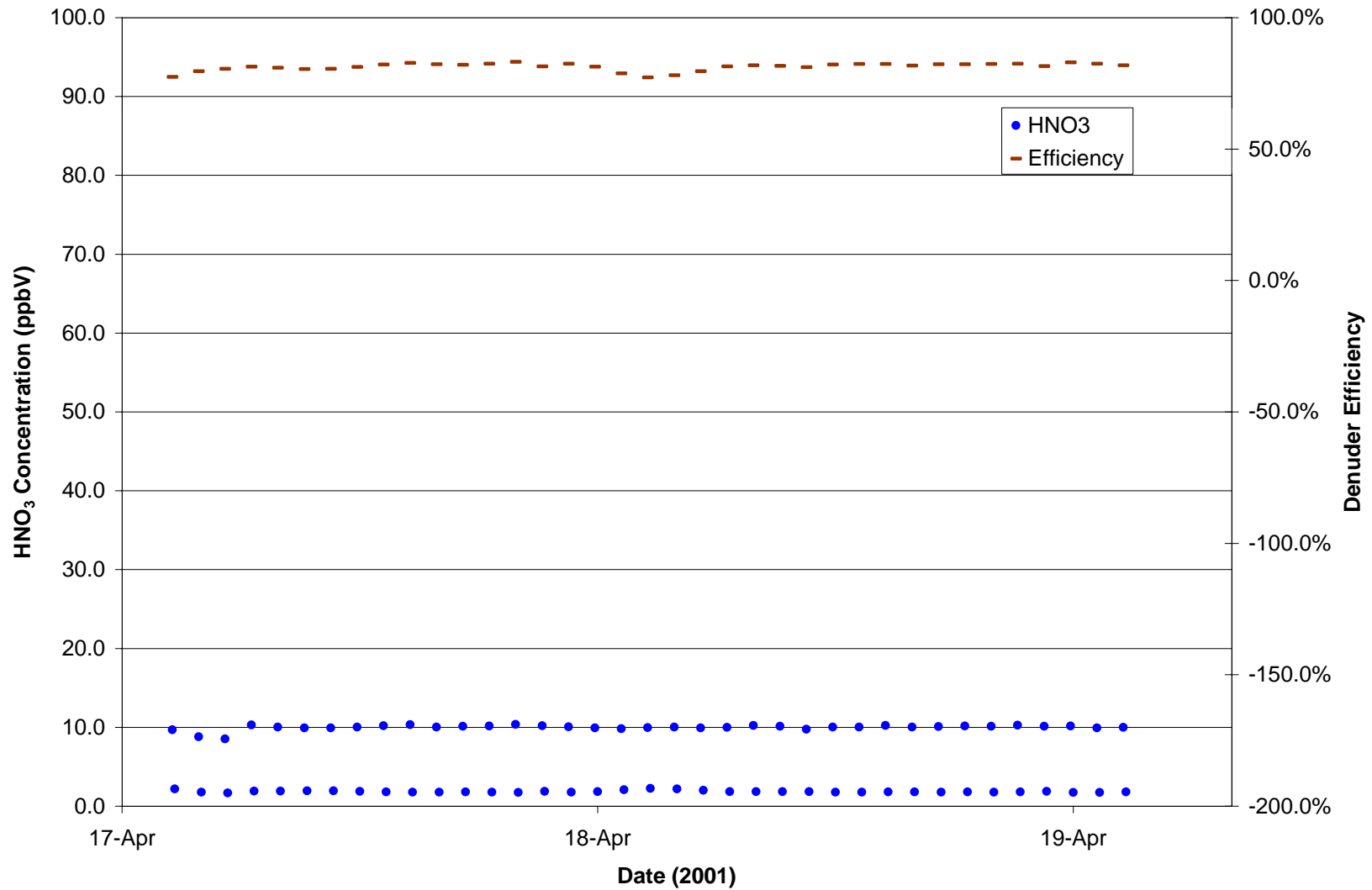

Experiment 5: Investigation of NaCl Coated Denuders (Low Humidity, Low HNO₃ Acid Concentration)

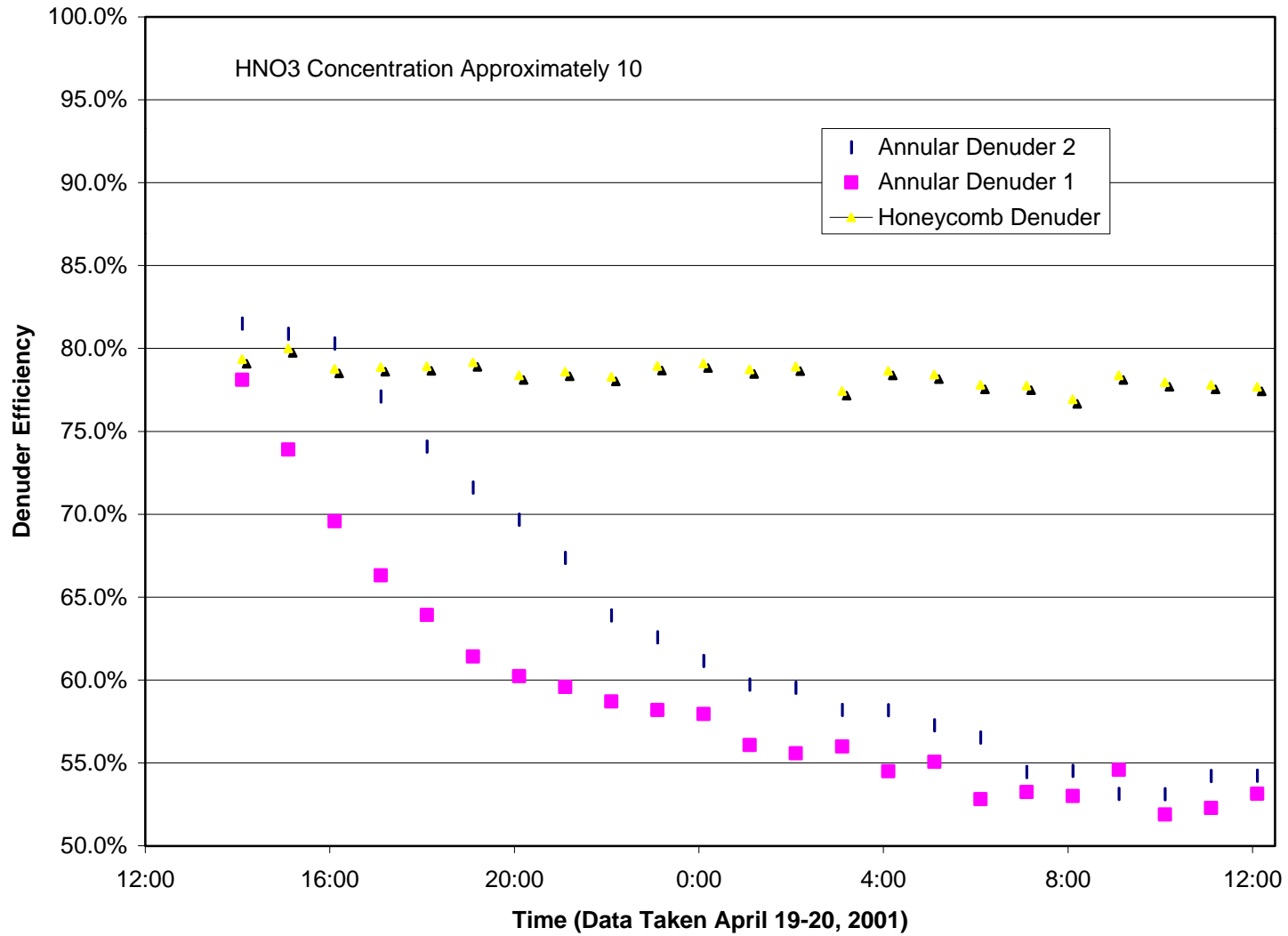

EPA Denuder Efficiency Evaluation Denuder 4

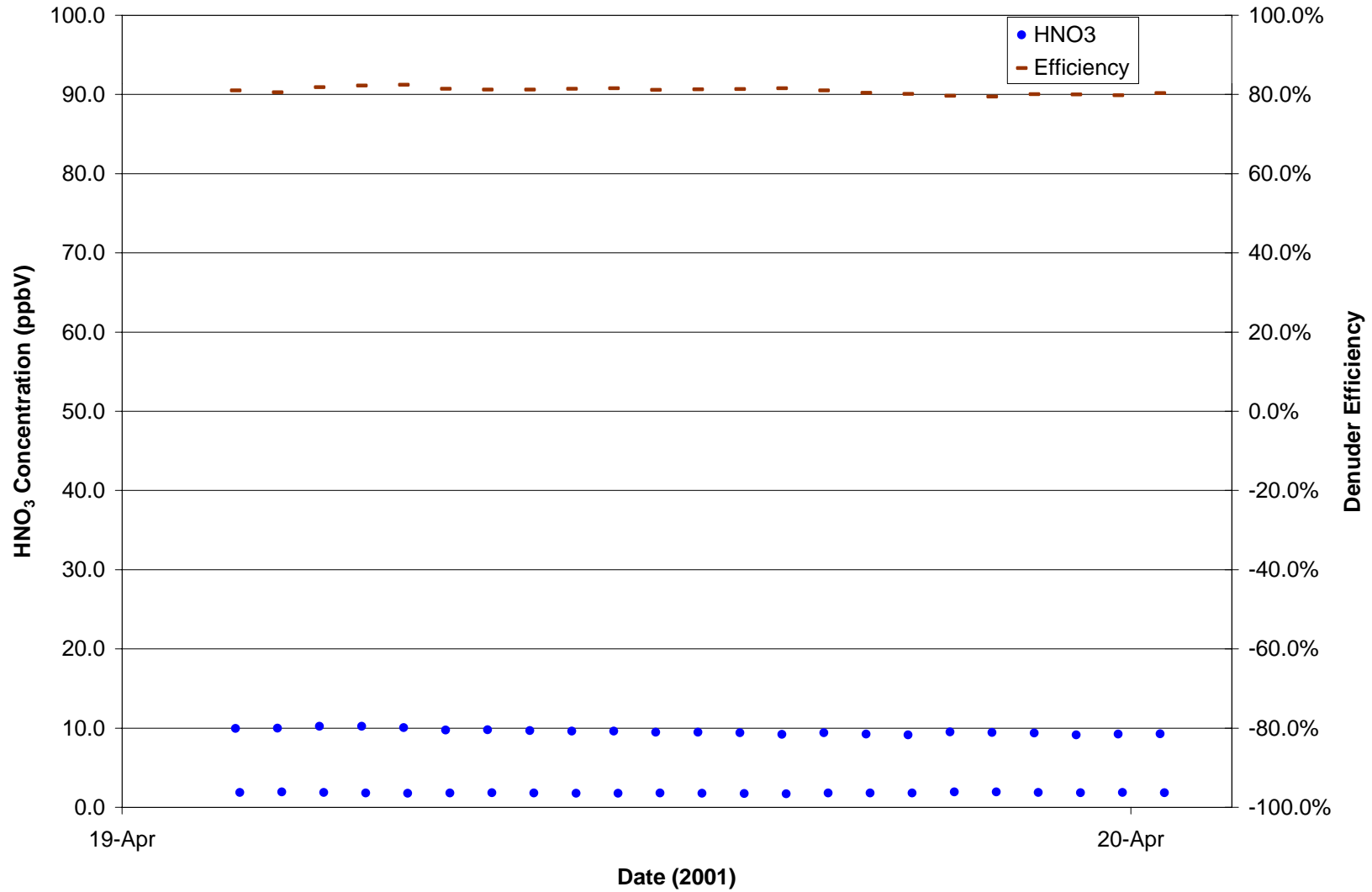

EPA Denuder Efficiency Evaluation Denuder 3

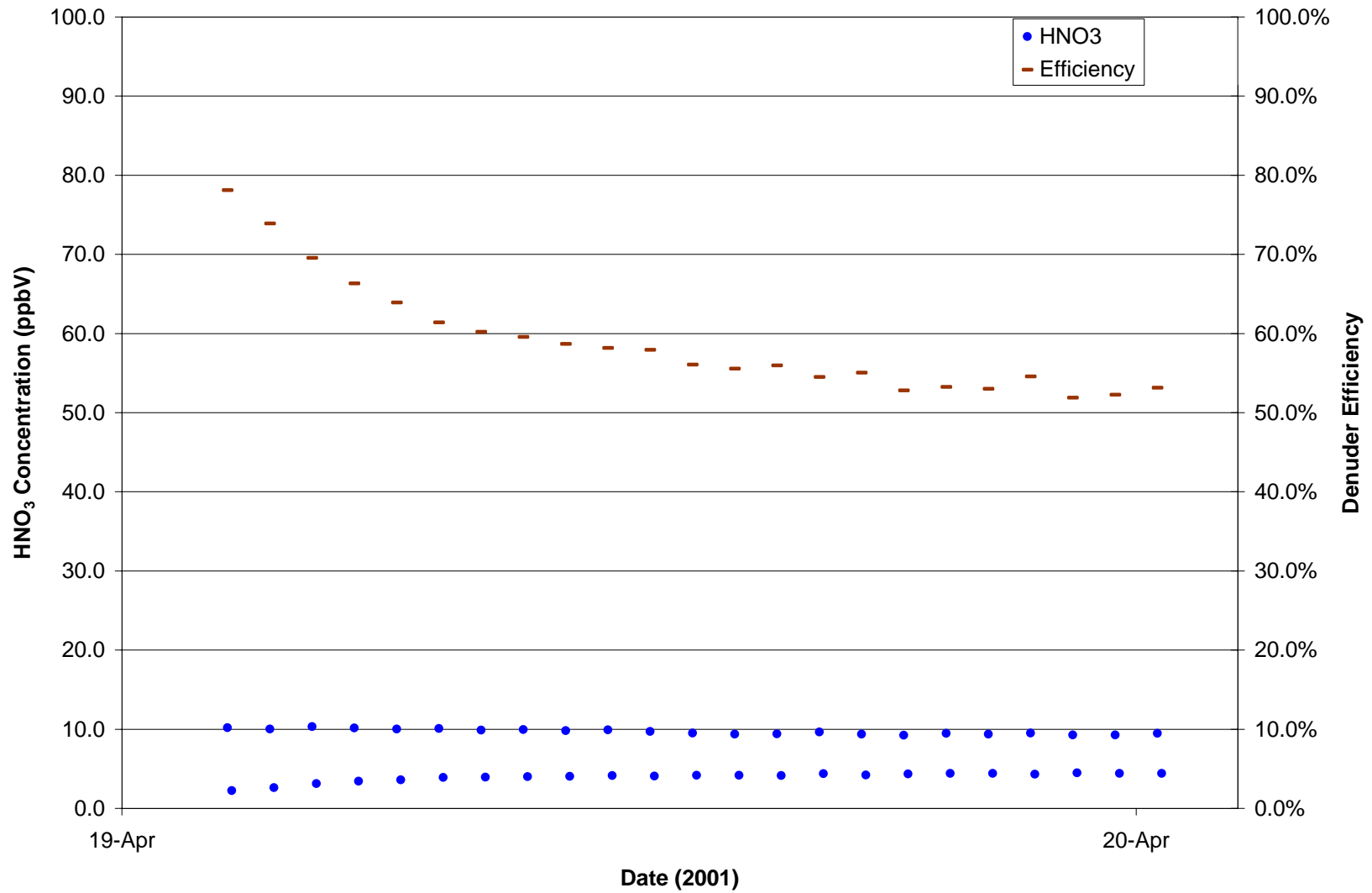

EPA Denuder Efficiency Evaluation Denuder 2

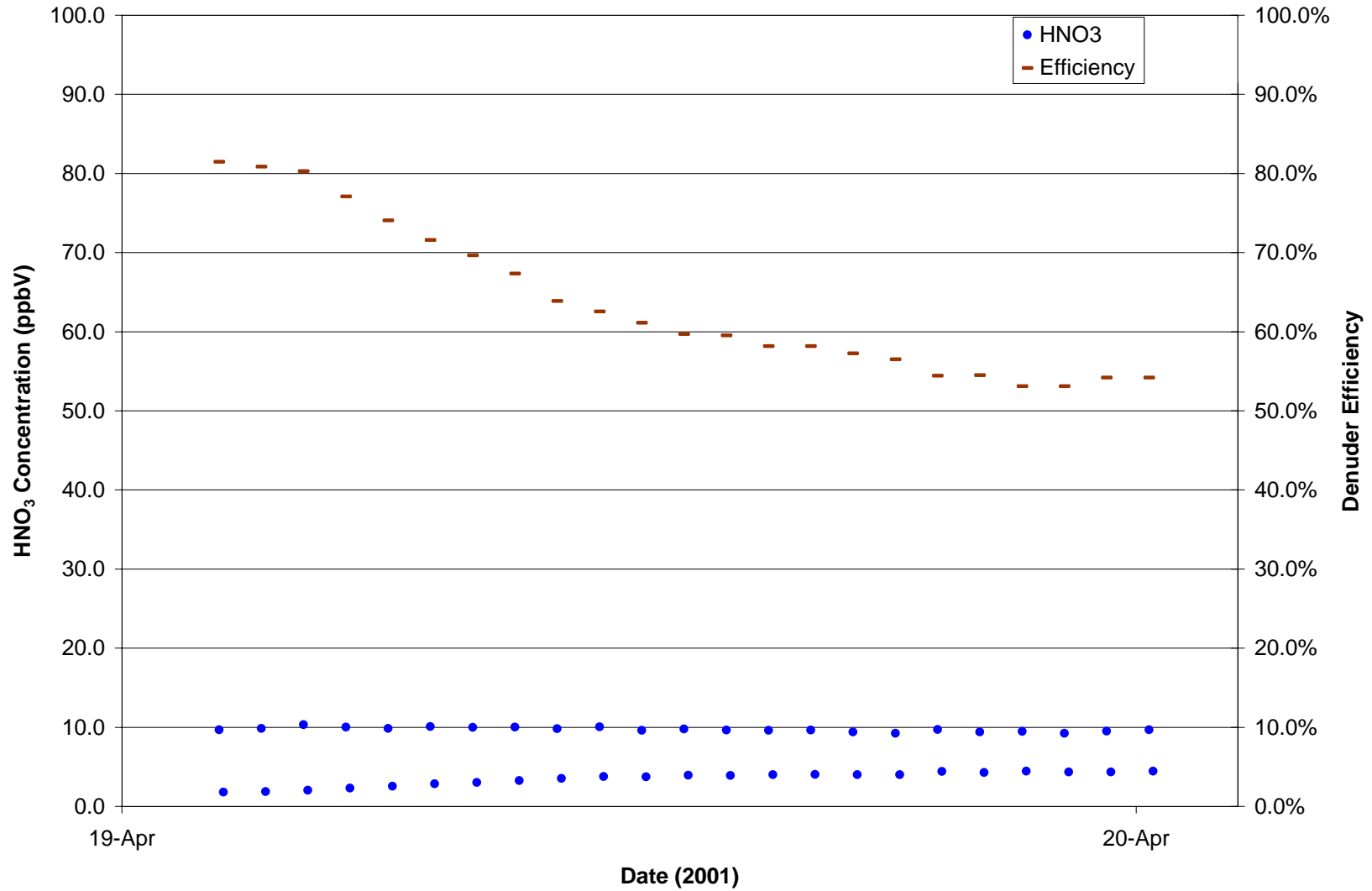

EPA Denuder Efficiency Evaluation Denuder 1

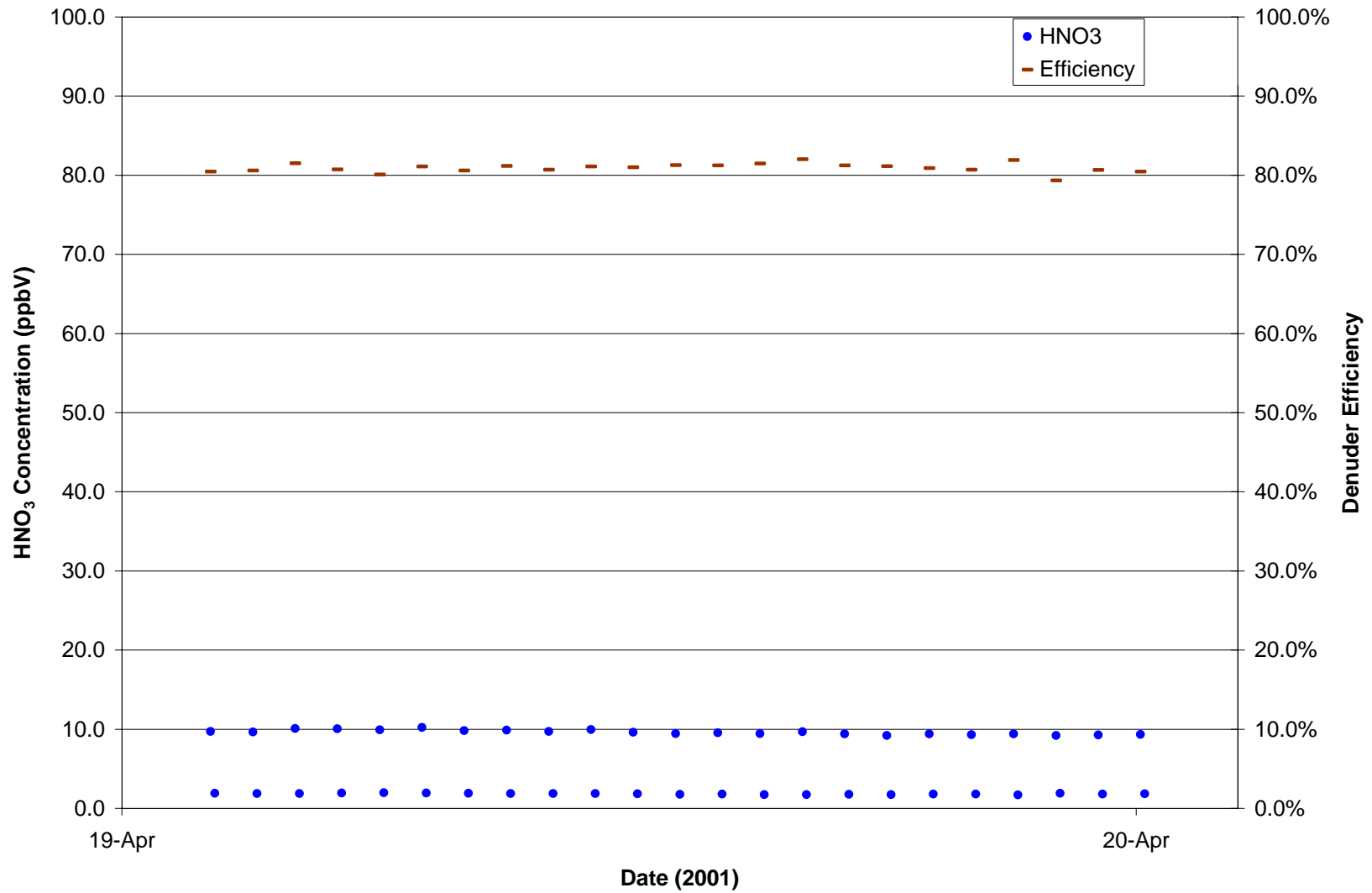

EPA Denuder Efficiency Evaluation Denuder 5

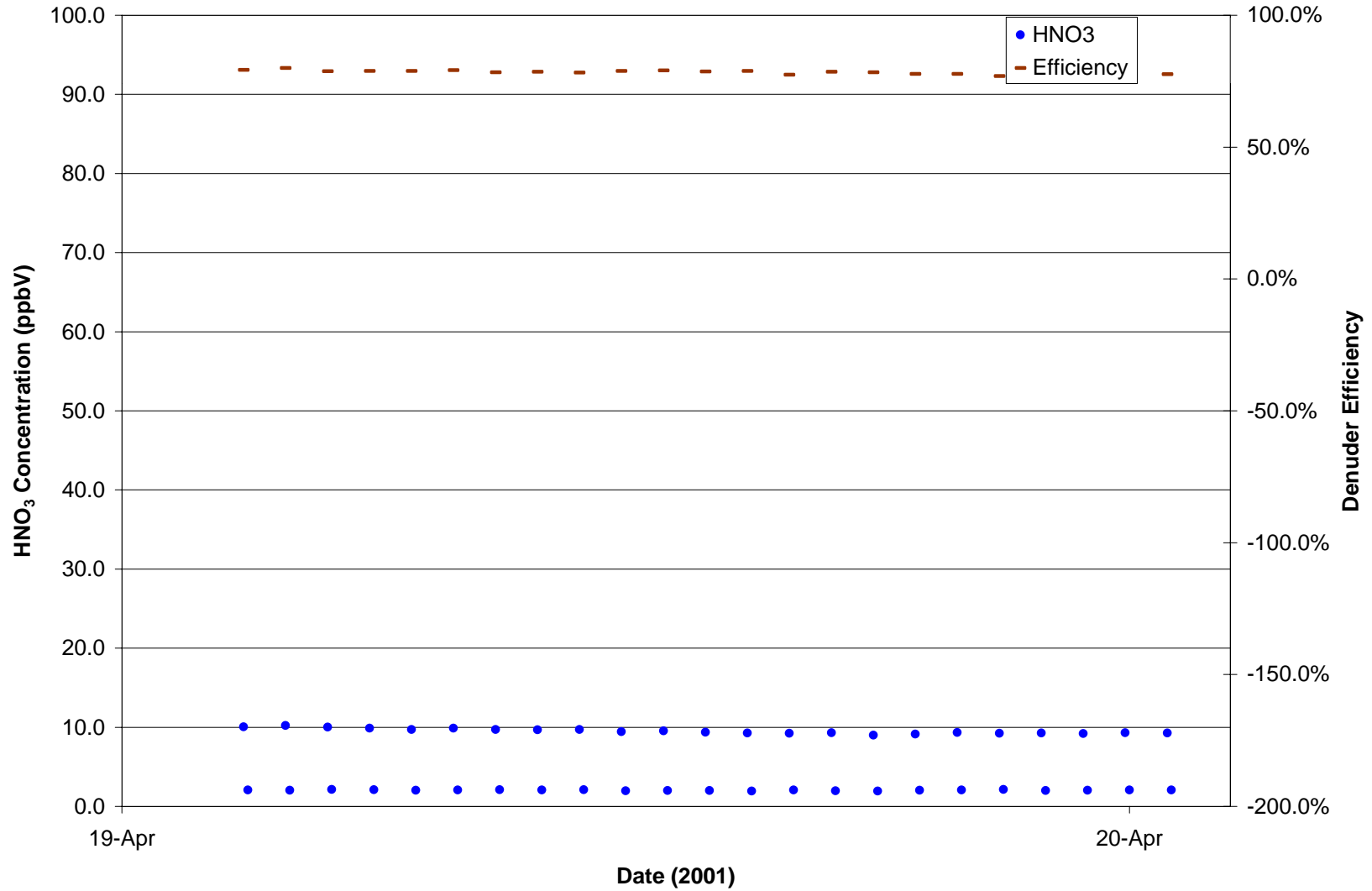

EPA Denuder Efficiency Evaluation Denuder 1 Experiment 6 (High Humidity, Low HNO₃ Concentration)

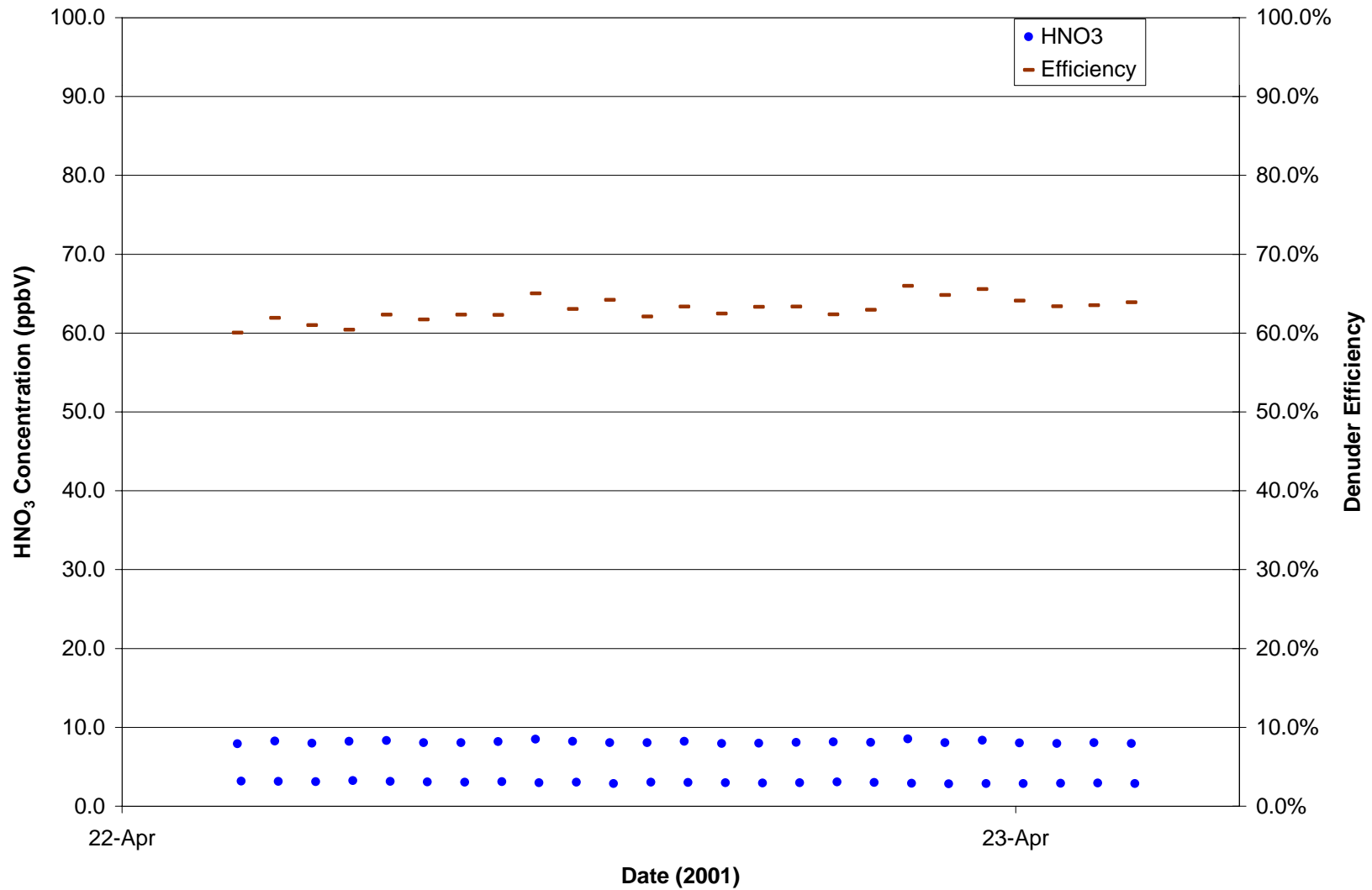

EPA Denuder Efficiency Evaluation Denuder 4 Experiment 6 (High Humidity, Low HNO3 Concentration)

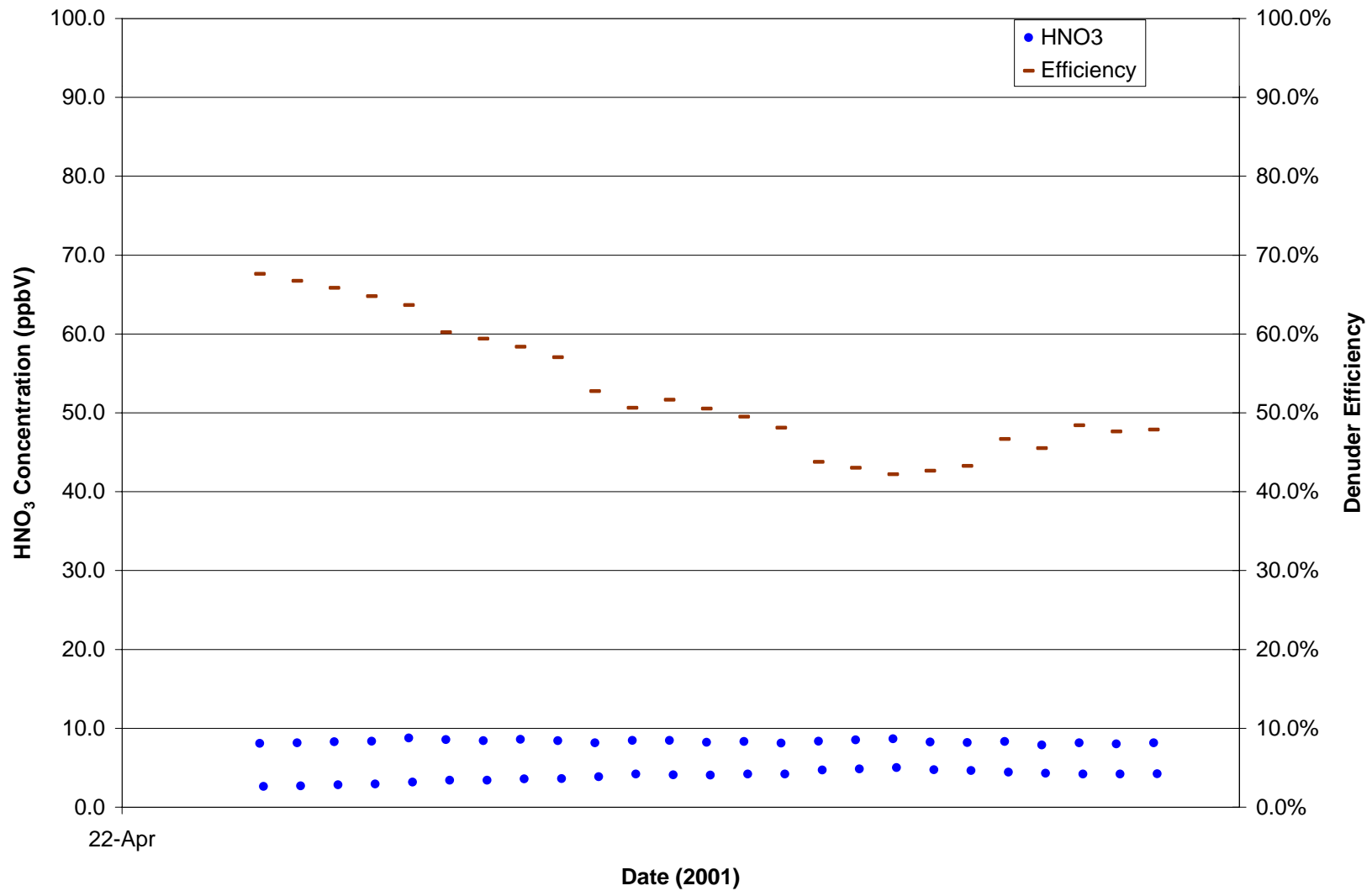

EPA Denuder Efficiency Evaluation Denuder 3 Experiment 6 (High Humidity, Low HNO3 Concentration)

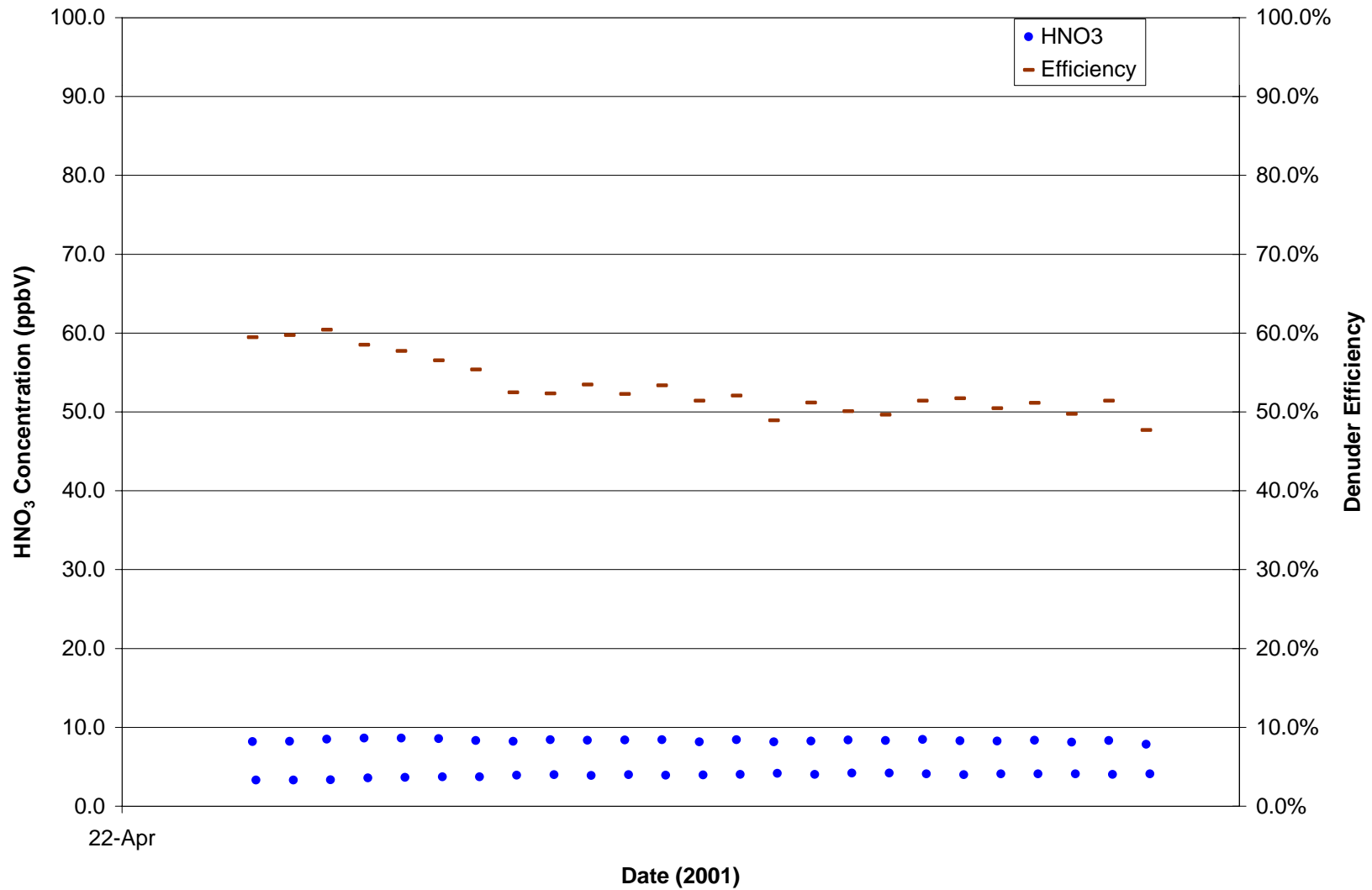

EPA Denuder Efficiency Evaluation Denuder 2
Experiment 6 (High Humidity, Low HNO3 Concentration)

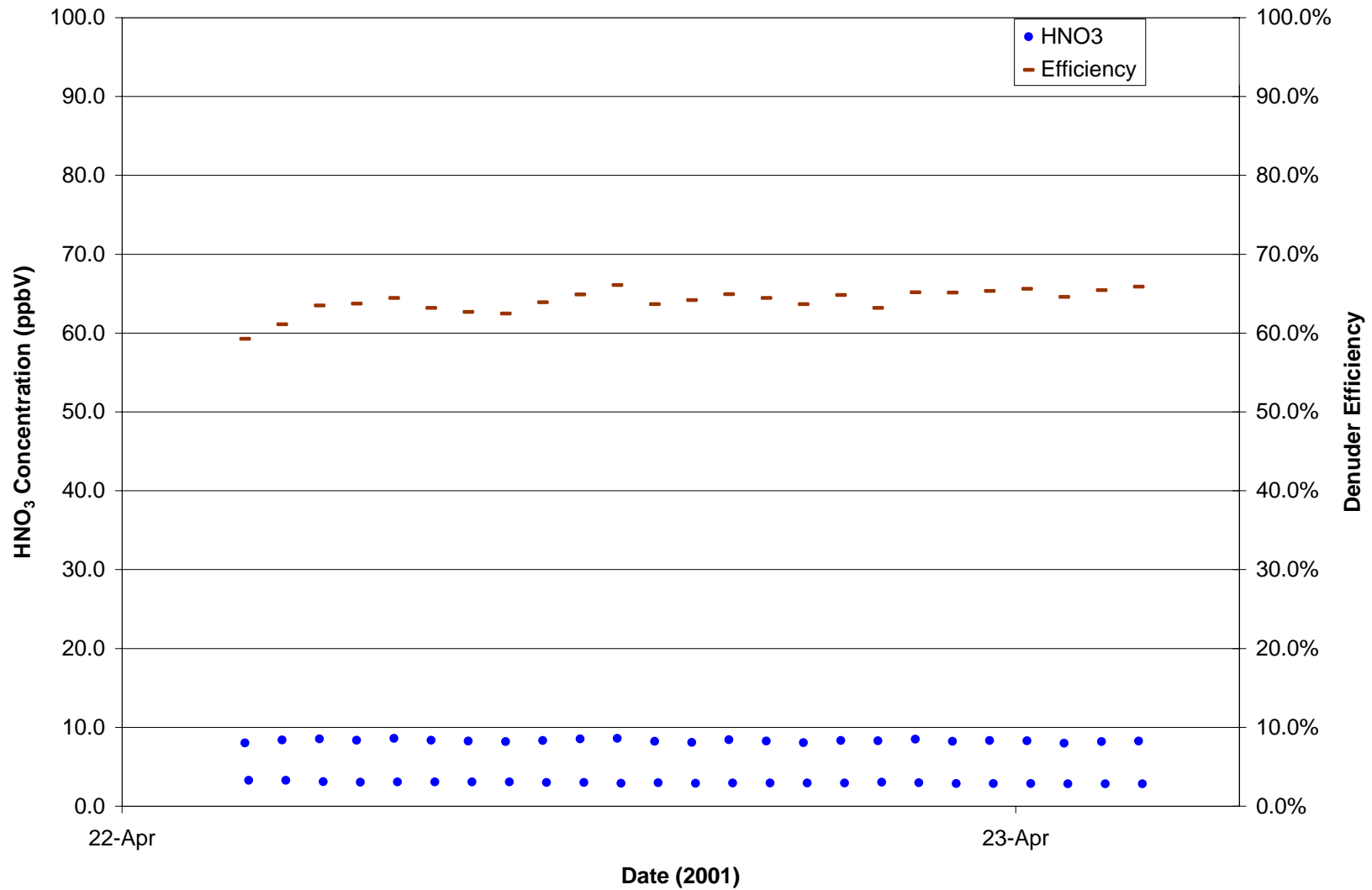

EPA Denuder Efficiency Evaluation Denuder 5 Experiment 6 (High Humidity, Low HNO3 Concentration)

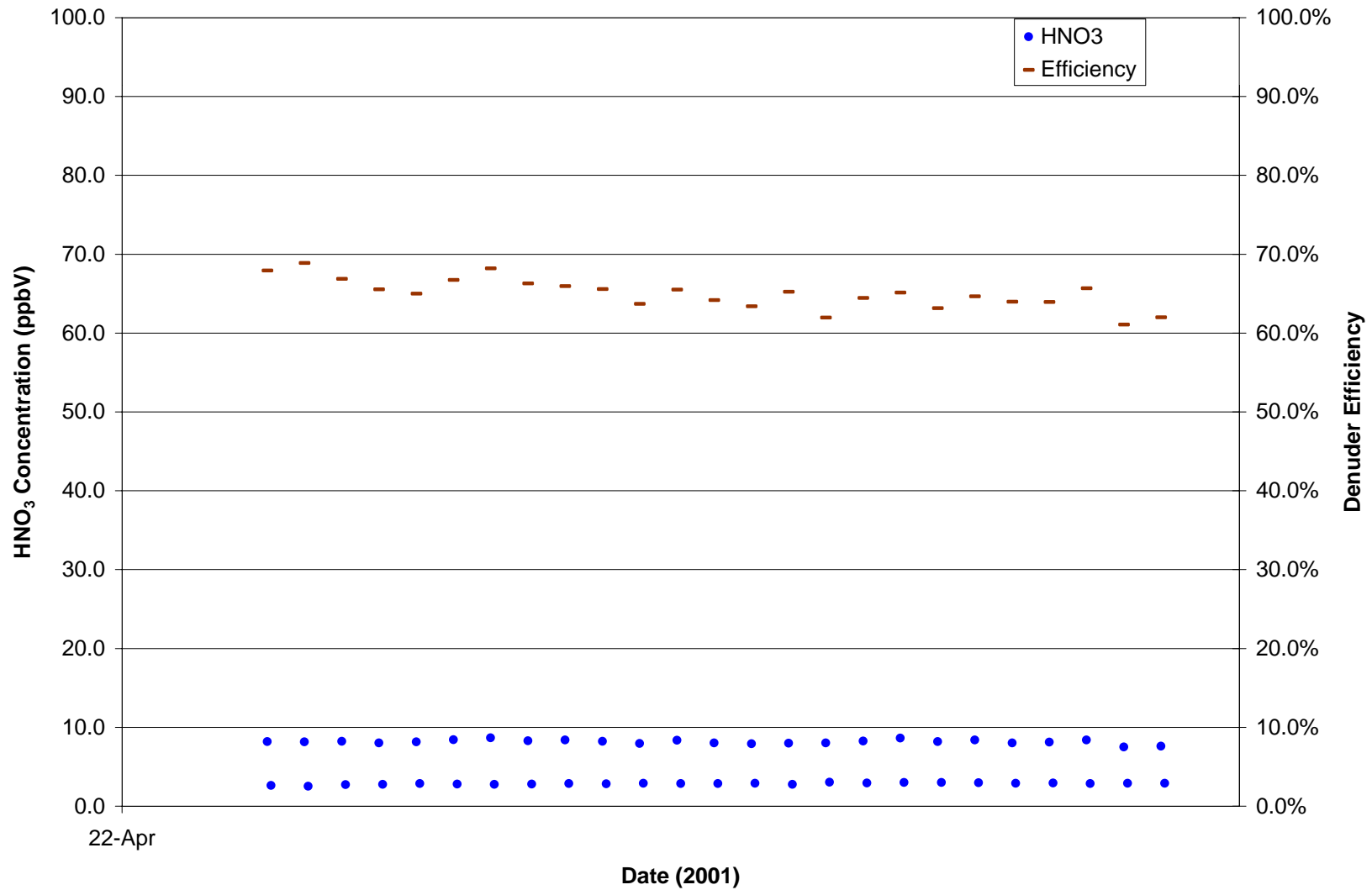

EPA Denuder Efficiency Evaluation Denuder 4
Experiment 7 (High Humidity, High HNO₃ Concentration)

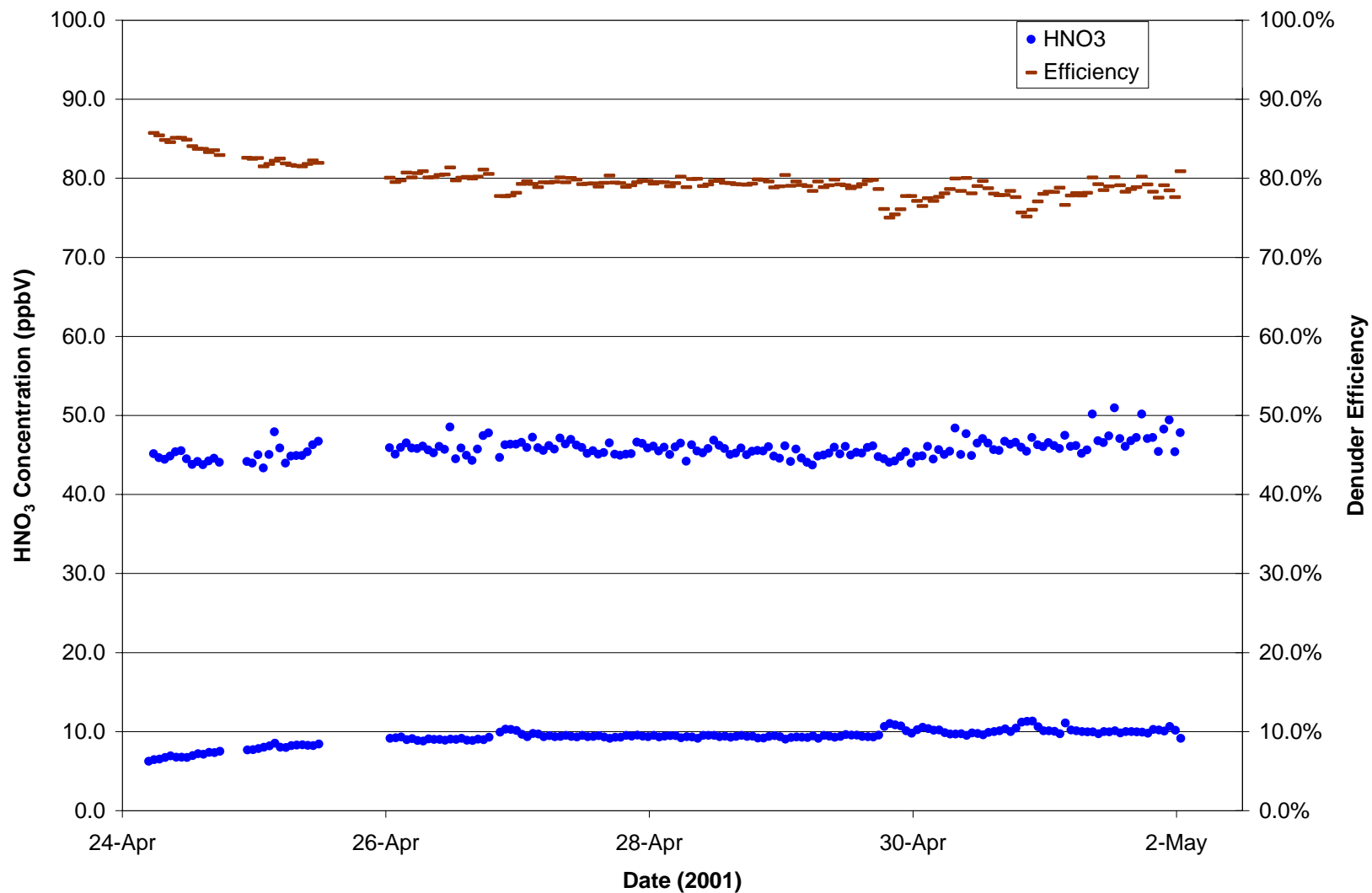

EPA Denuder Efficiency Evaluation Denuder 3
Experiment 7 (High Humidity, High HNO₃ Concentration)

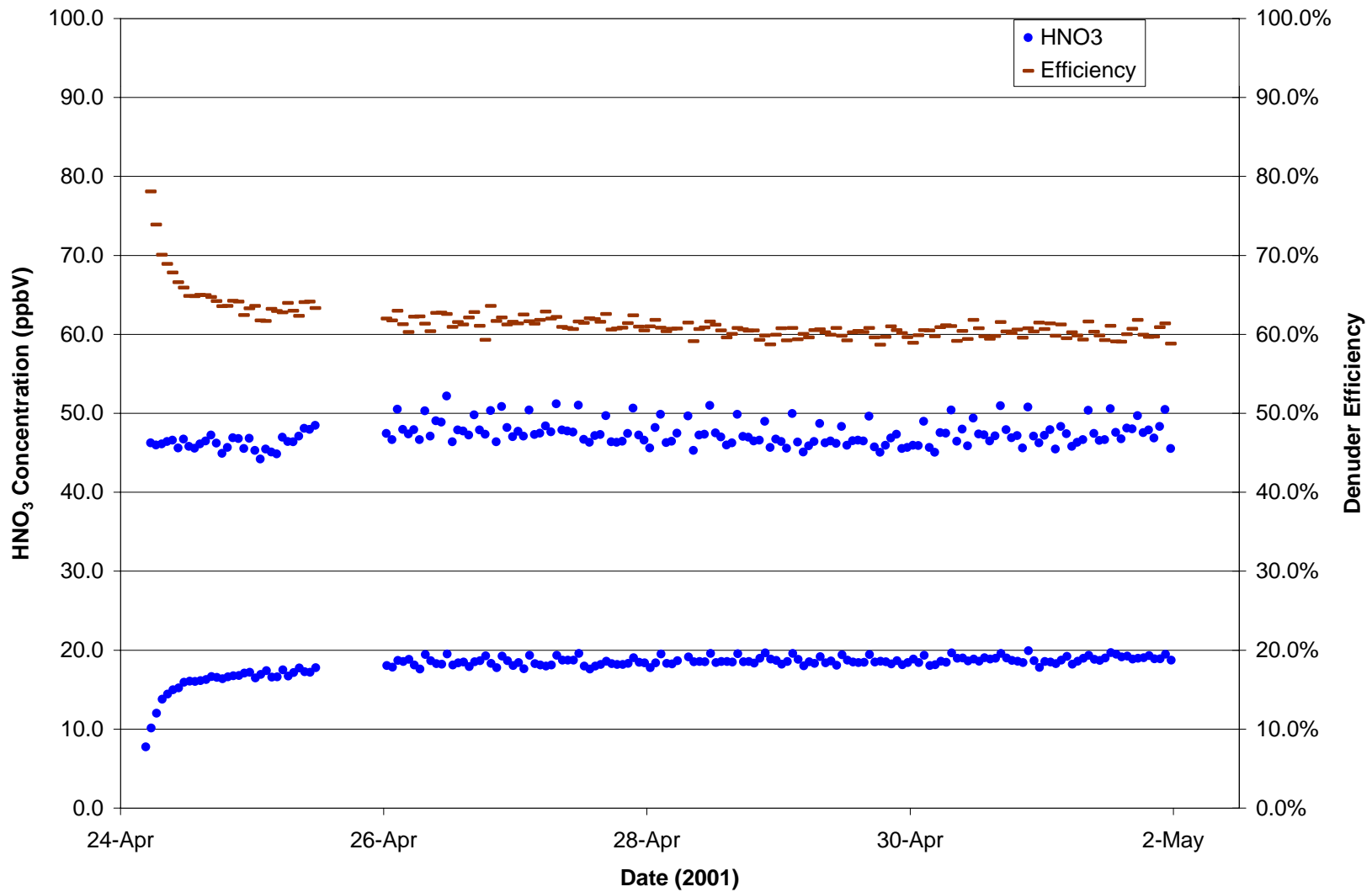

EPA Denuder Efficiency Evaluation Denuder 2 Experiment 7 (High Humidity, High HNO₃ Concentration)

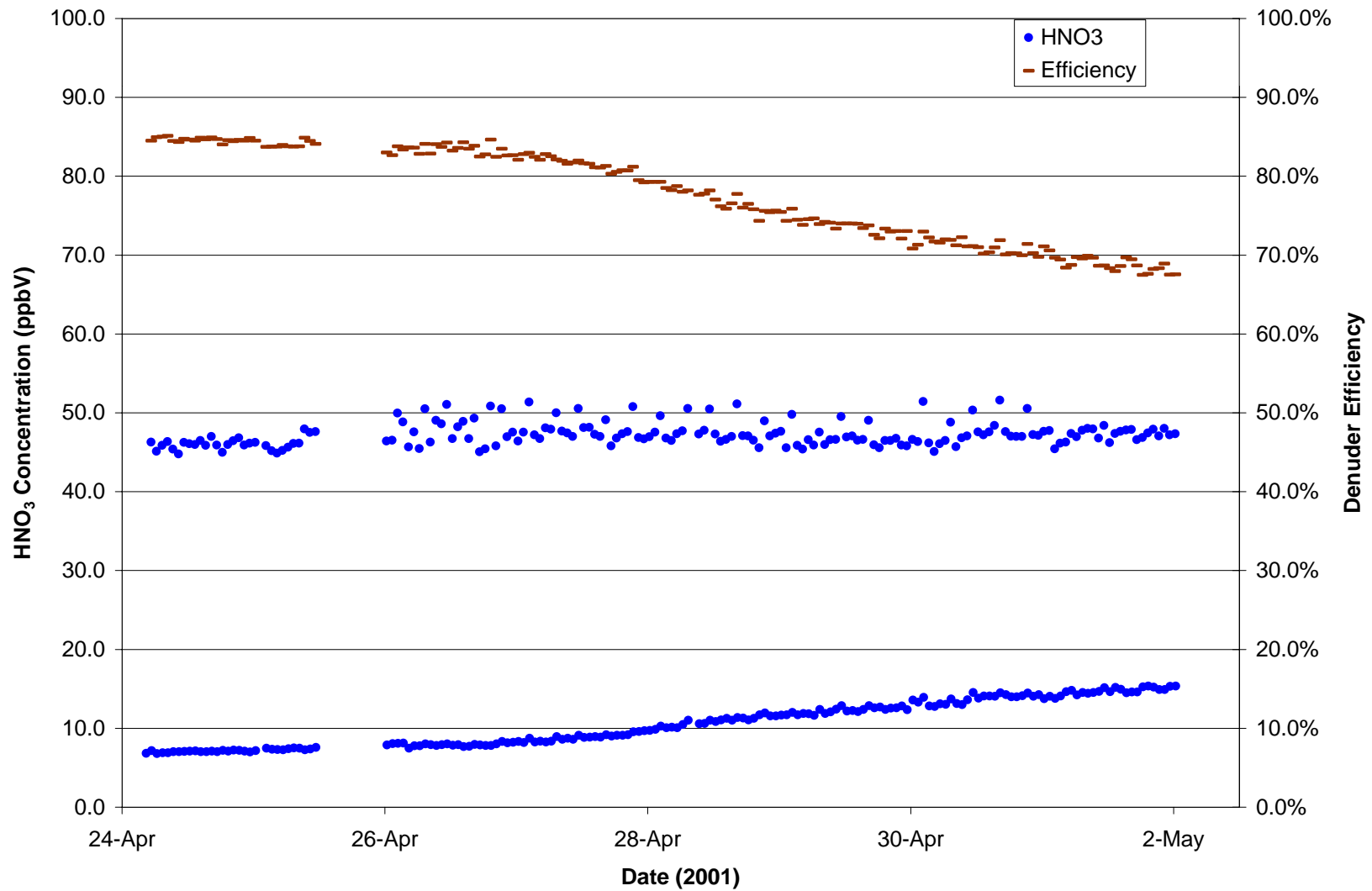

EPA Denuder Efficiency Evaluation Denuder 5
Experiment 7 (High Humidity, High HNO₃ Concentration)

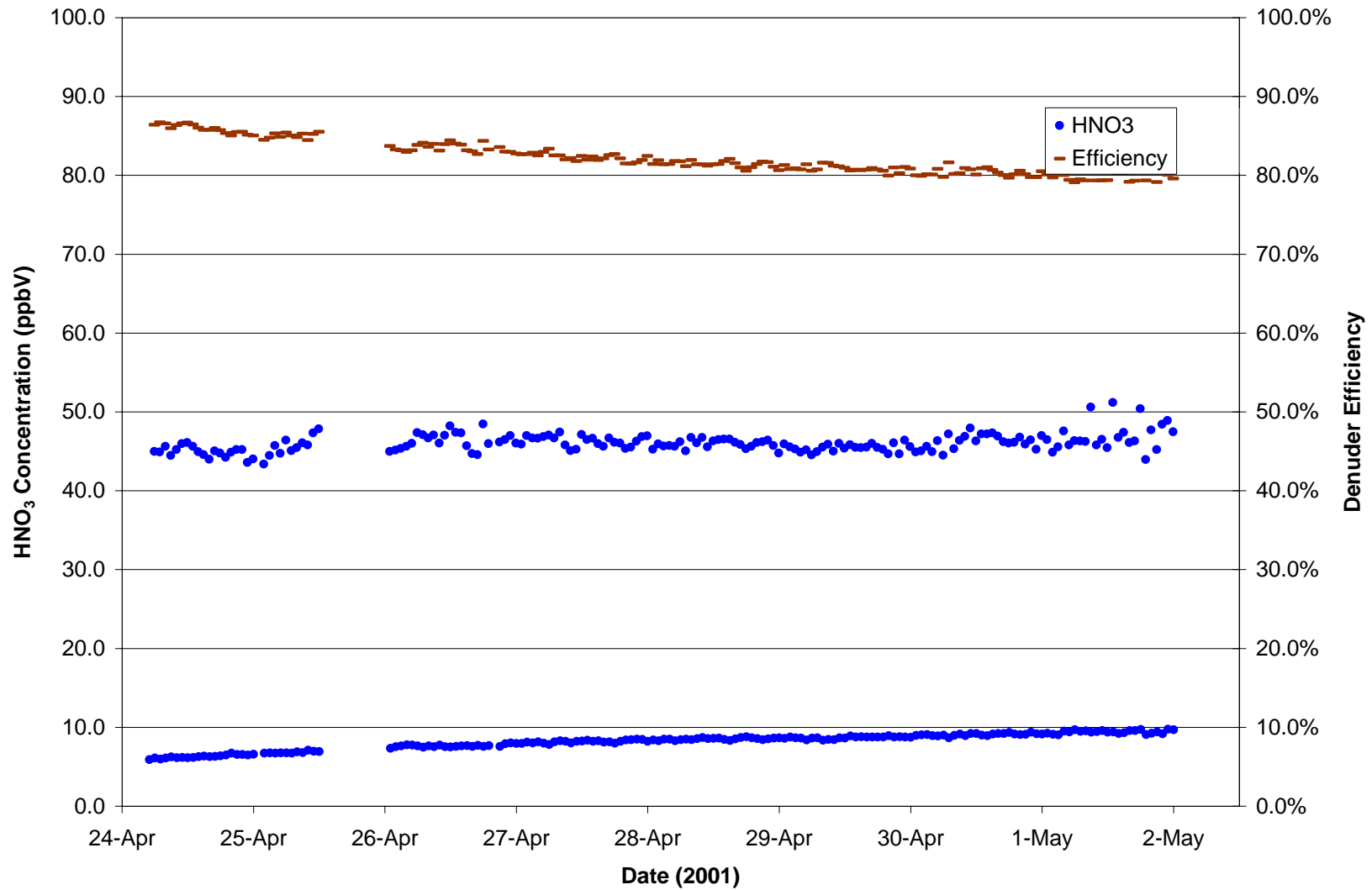

EPA Denuder Efficiency Evaluation Denuder 3 Experiment 8 (High Humidity, High NO₂ Concentration)

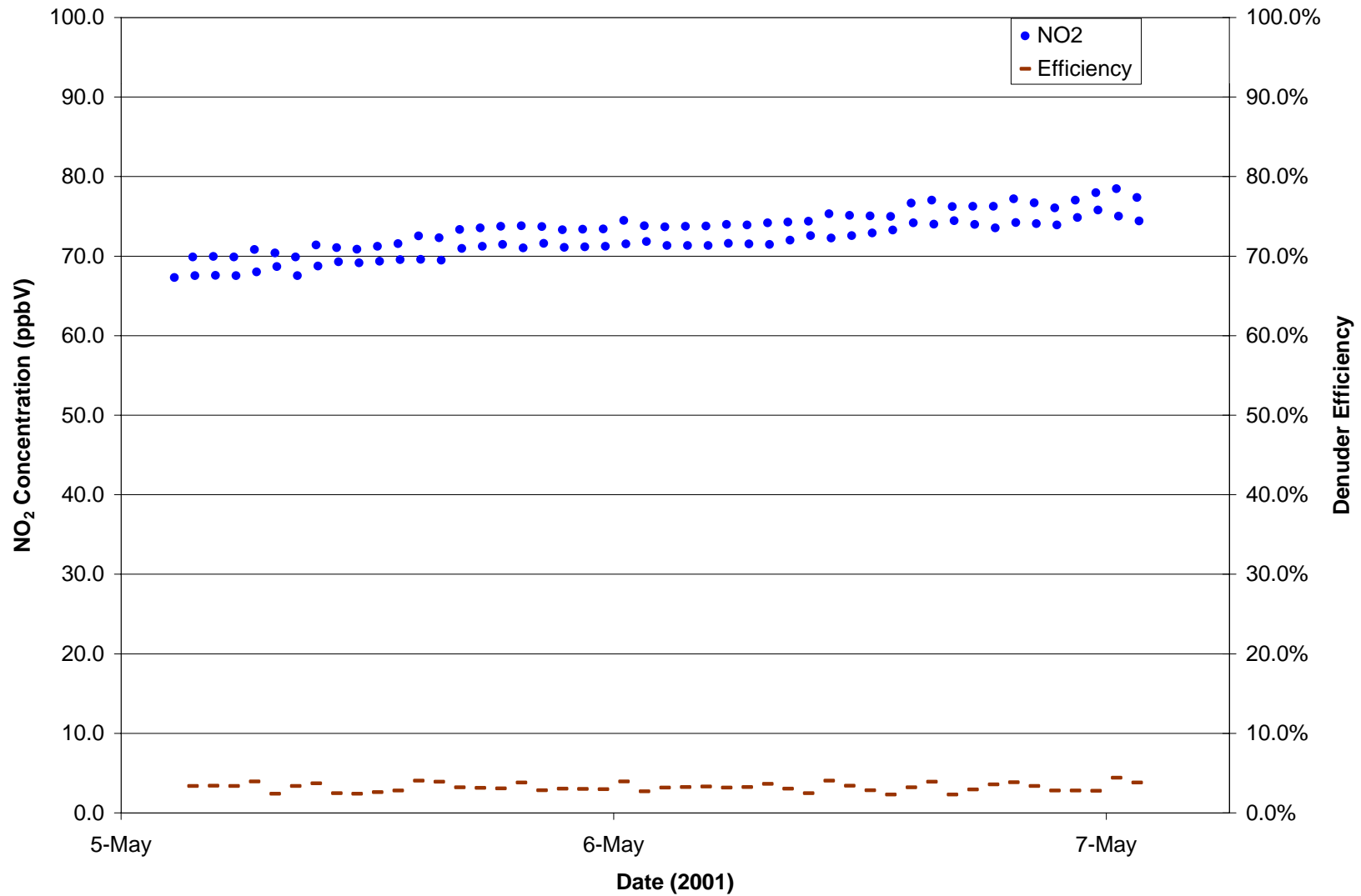

EPA Denuder Efficiency Evaluation Denuder 4
Experiment 8 (High Humidity, High NO₂ Concentration)

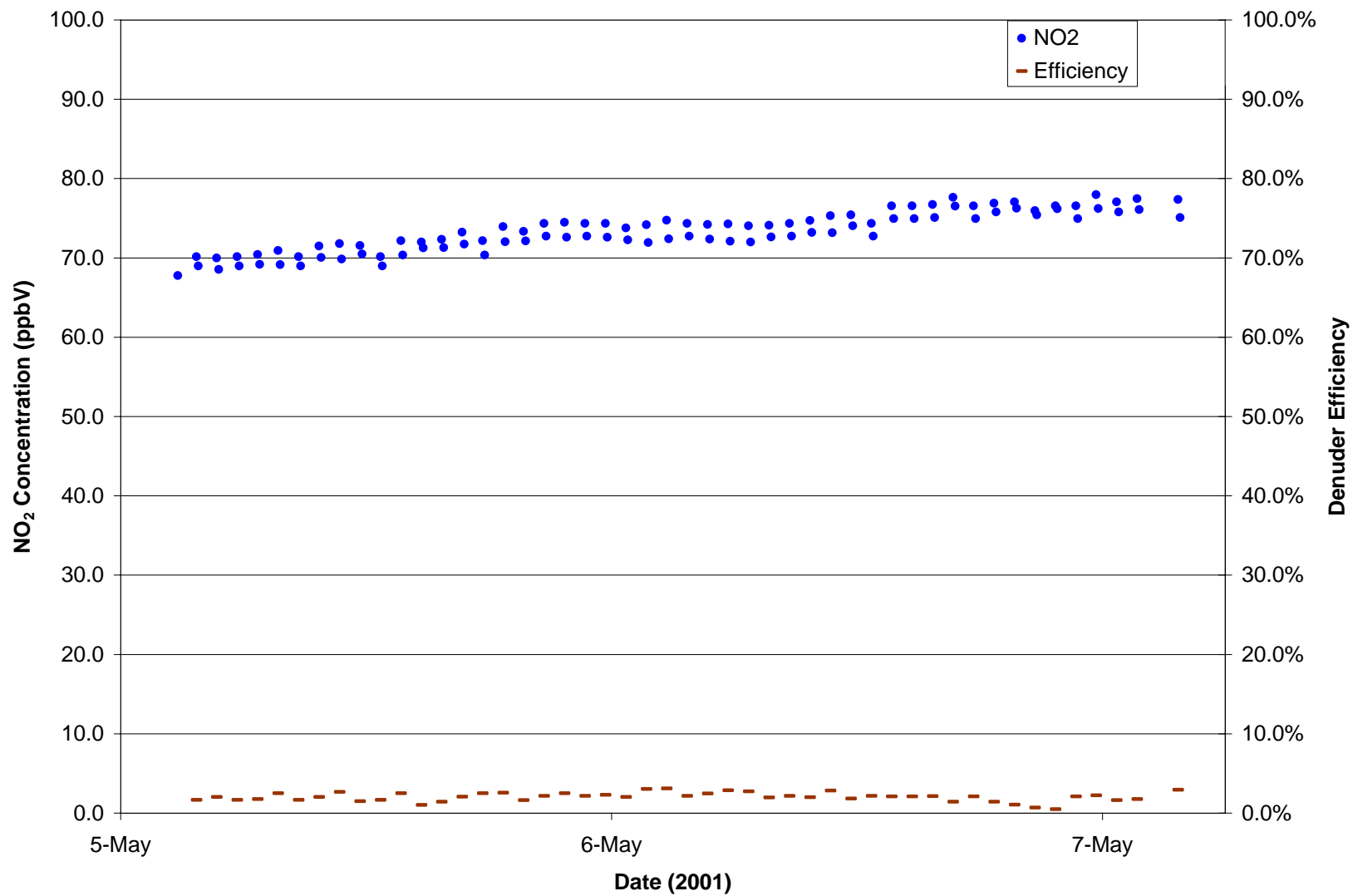

EPA Denuder Efficiency Evaluation Denuder 5
Experiment 8 (High Humidity, High NO2 Concentration)

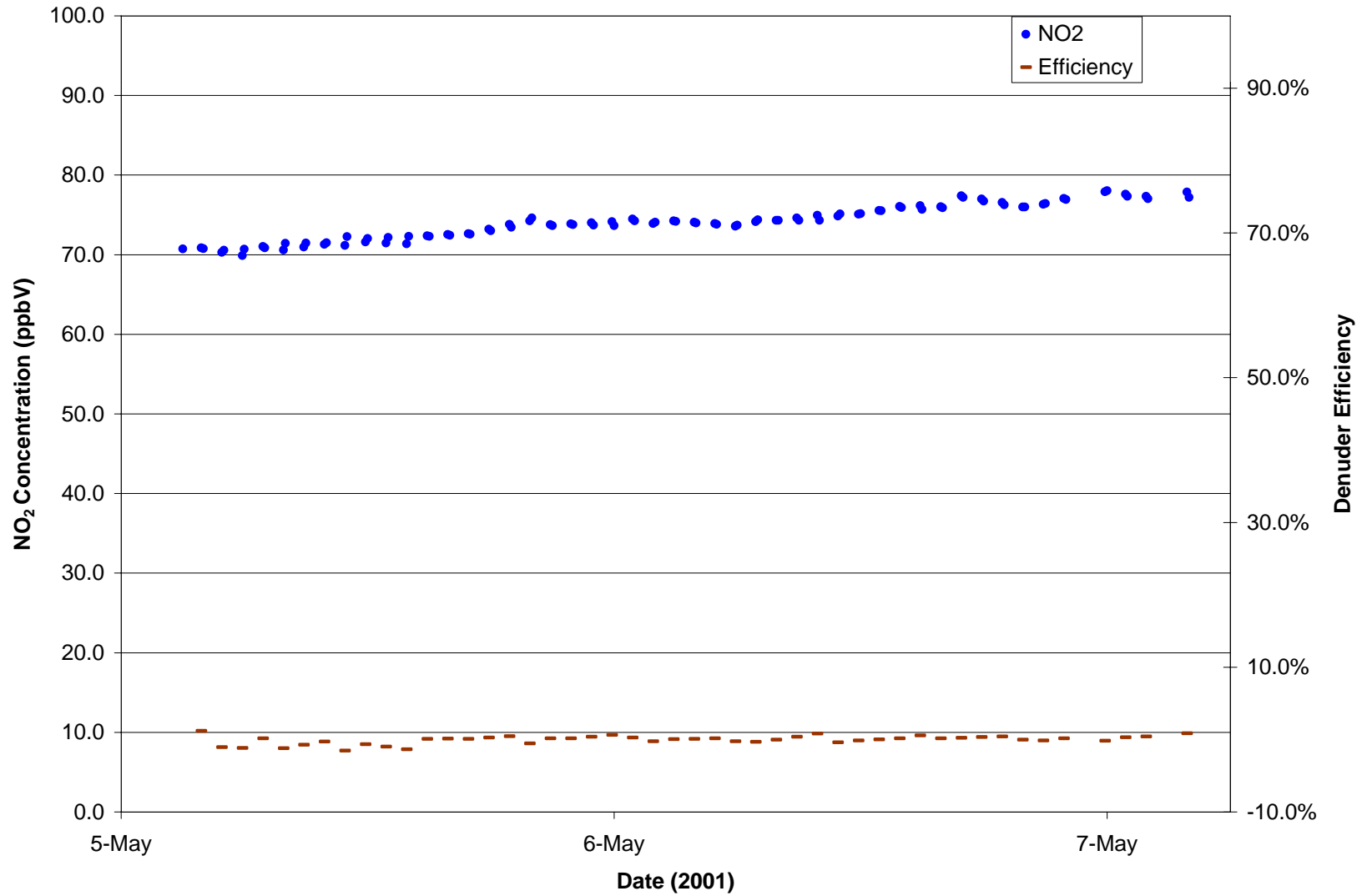

EPA Denuder Efficiency Evaluation Denuder 1
Experiment 9 (Low Humidity, High NO2 Concentration)

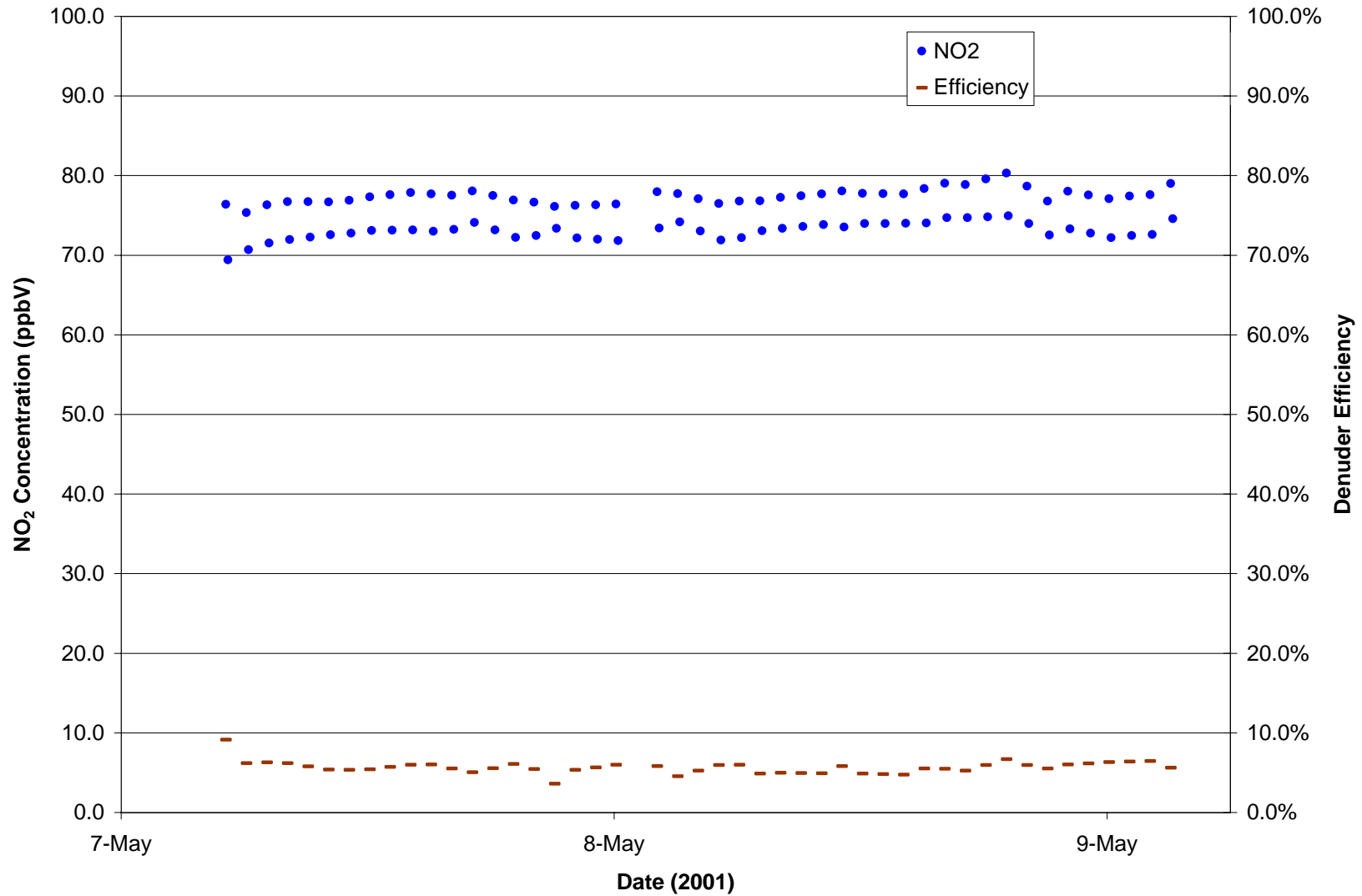

EPA Denuder Efficiency Evaluation Denuder 2 Experiment 9 (Low Humidity, High NO2 Concentration)

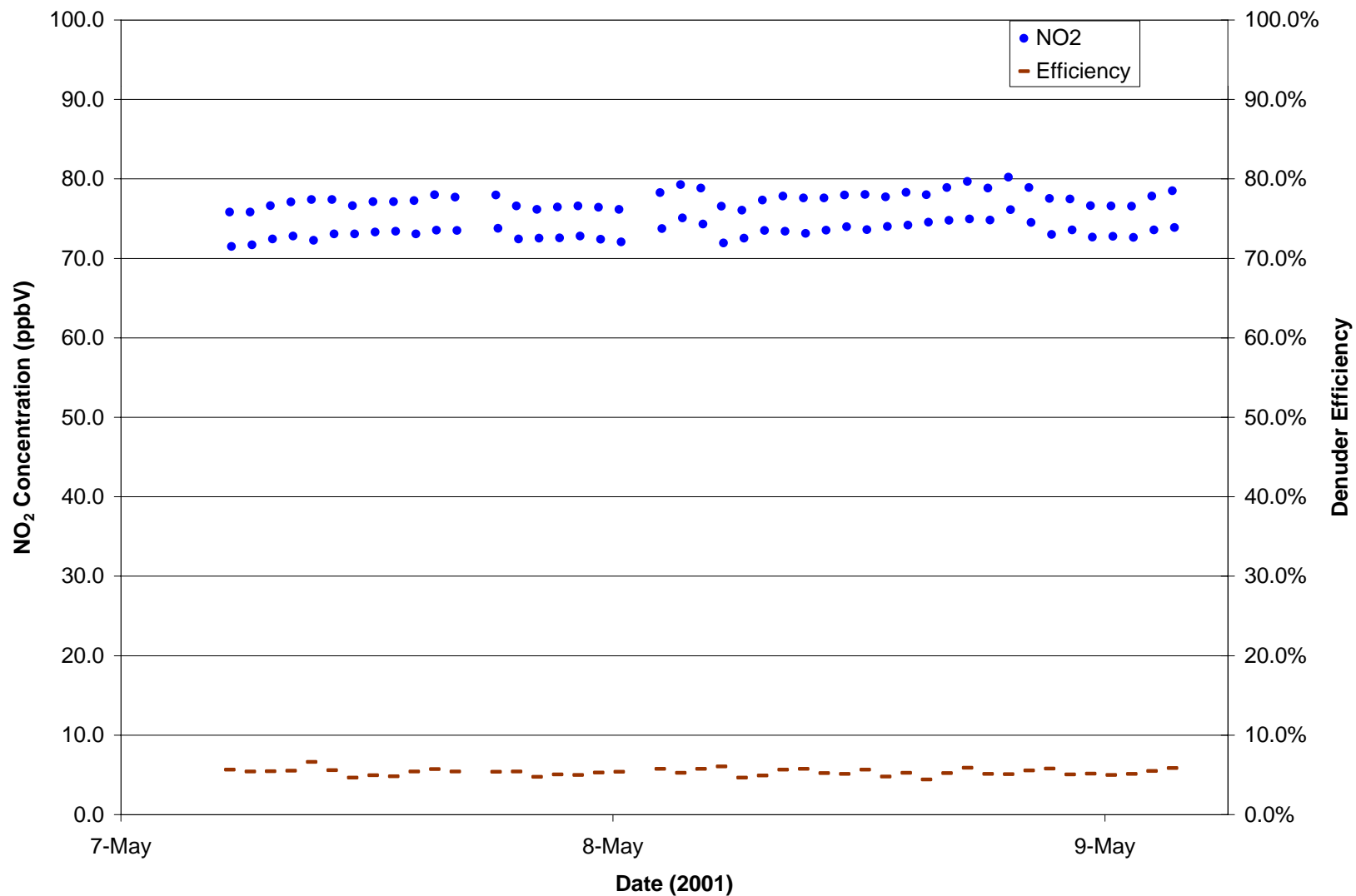

EPA Denuder Efficiency Evaluation Denuder 3
Experiment 9 (Low Humidity, High NO2 Concentration)

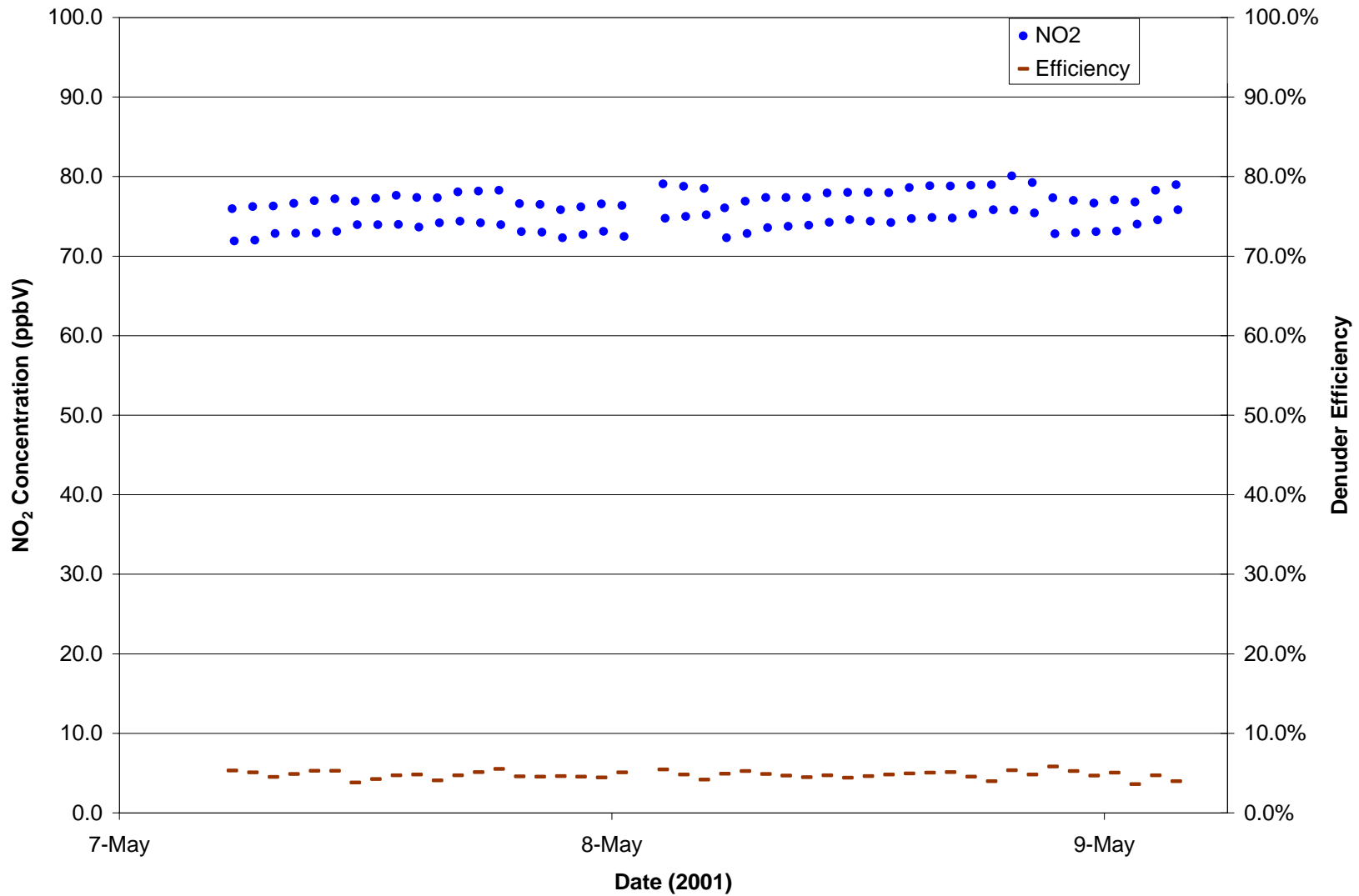

EPA Denuder Efficiency Evaluation Denuder 4 Experiment 9 (Low Humidity, High NO2 Concentration)

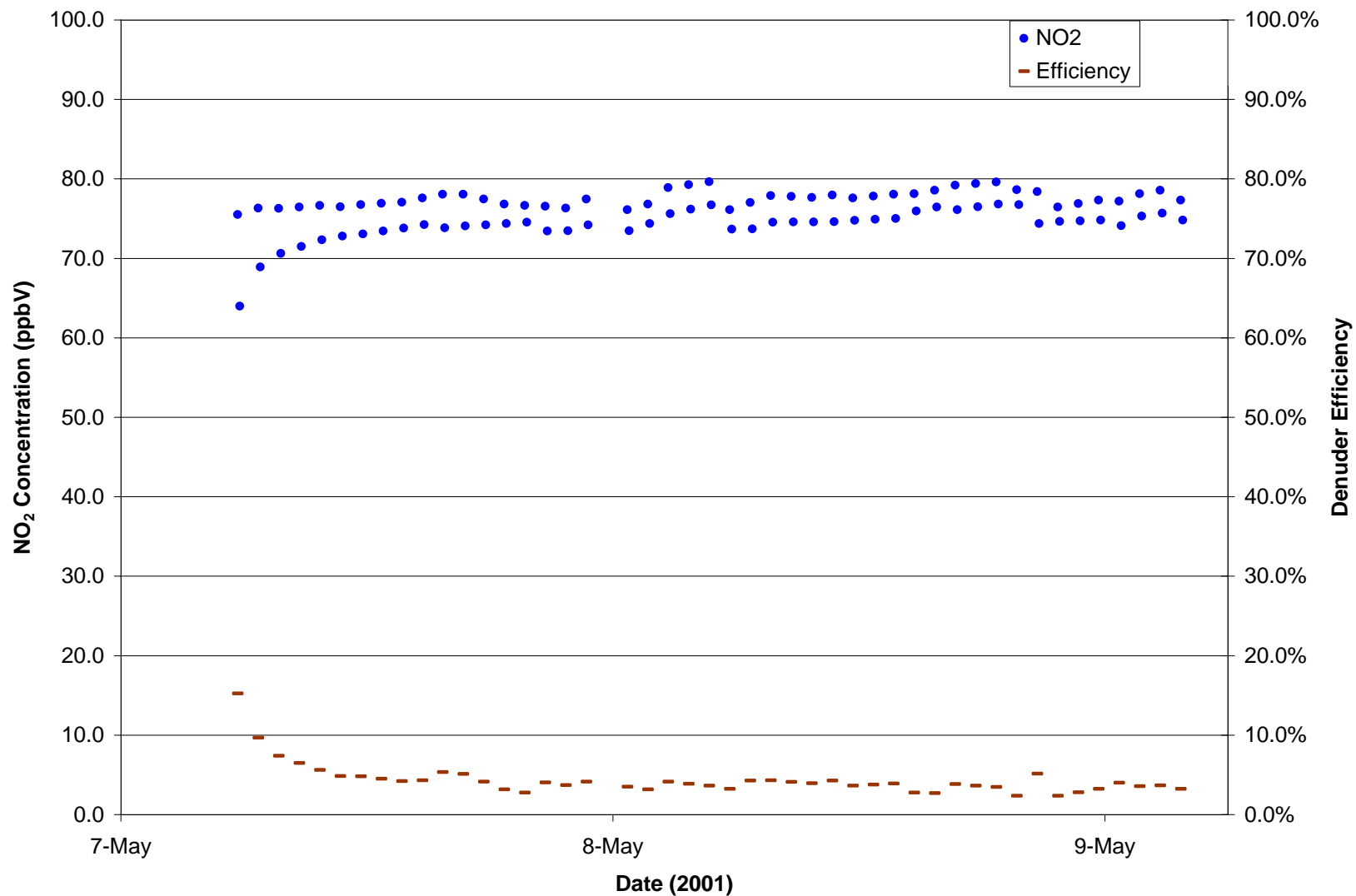

EPA Denuder Efficiency Evaluation Denuder 5
Experiment 9 (Low Humidity, High NO2 Concentration)

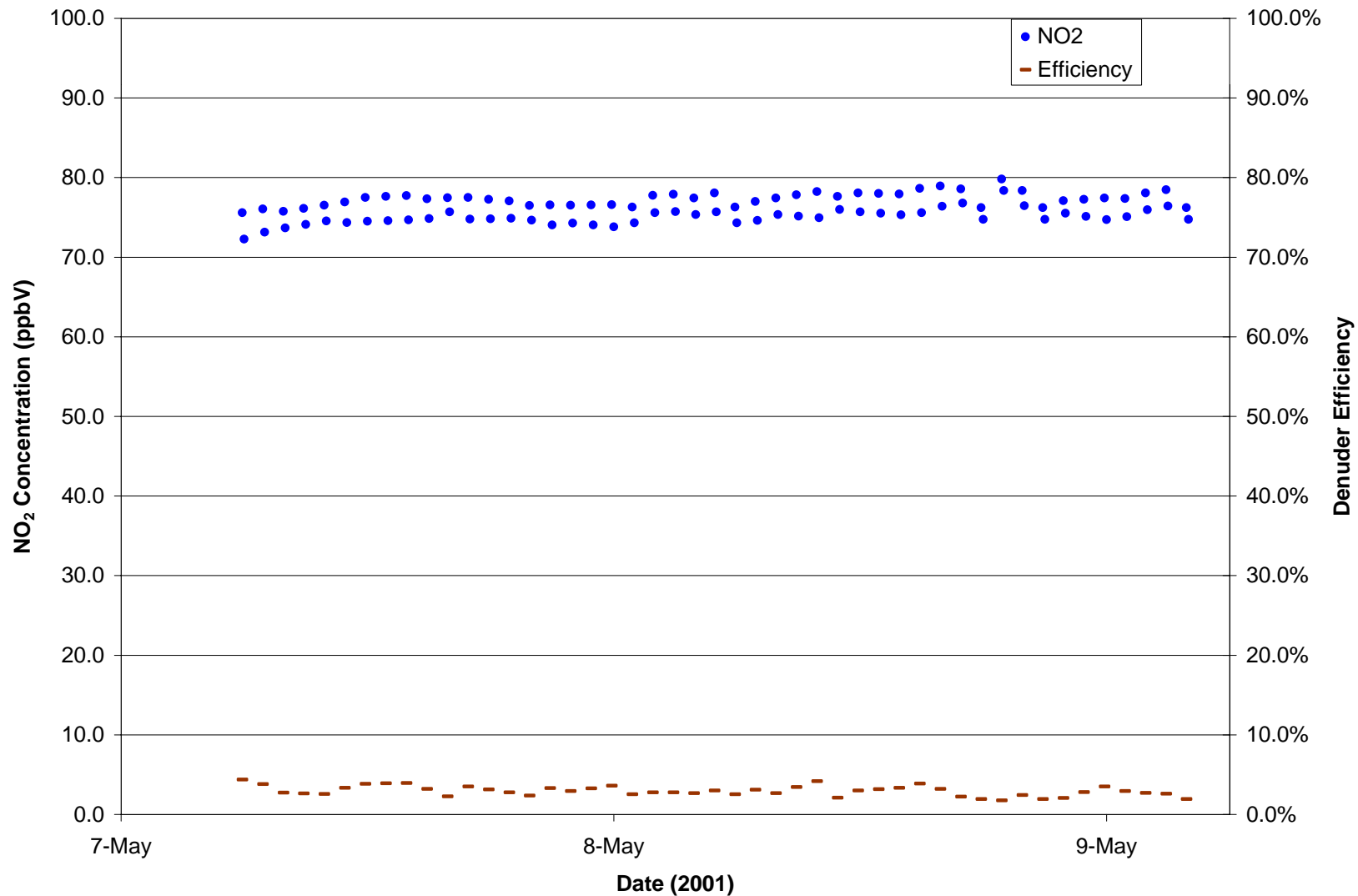

EPA Denuder Efficiency Evaluation Denuder 1 Experiment 10 (Low Humidity, Low NO2 Concentration)

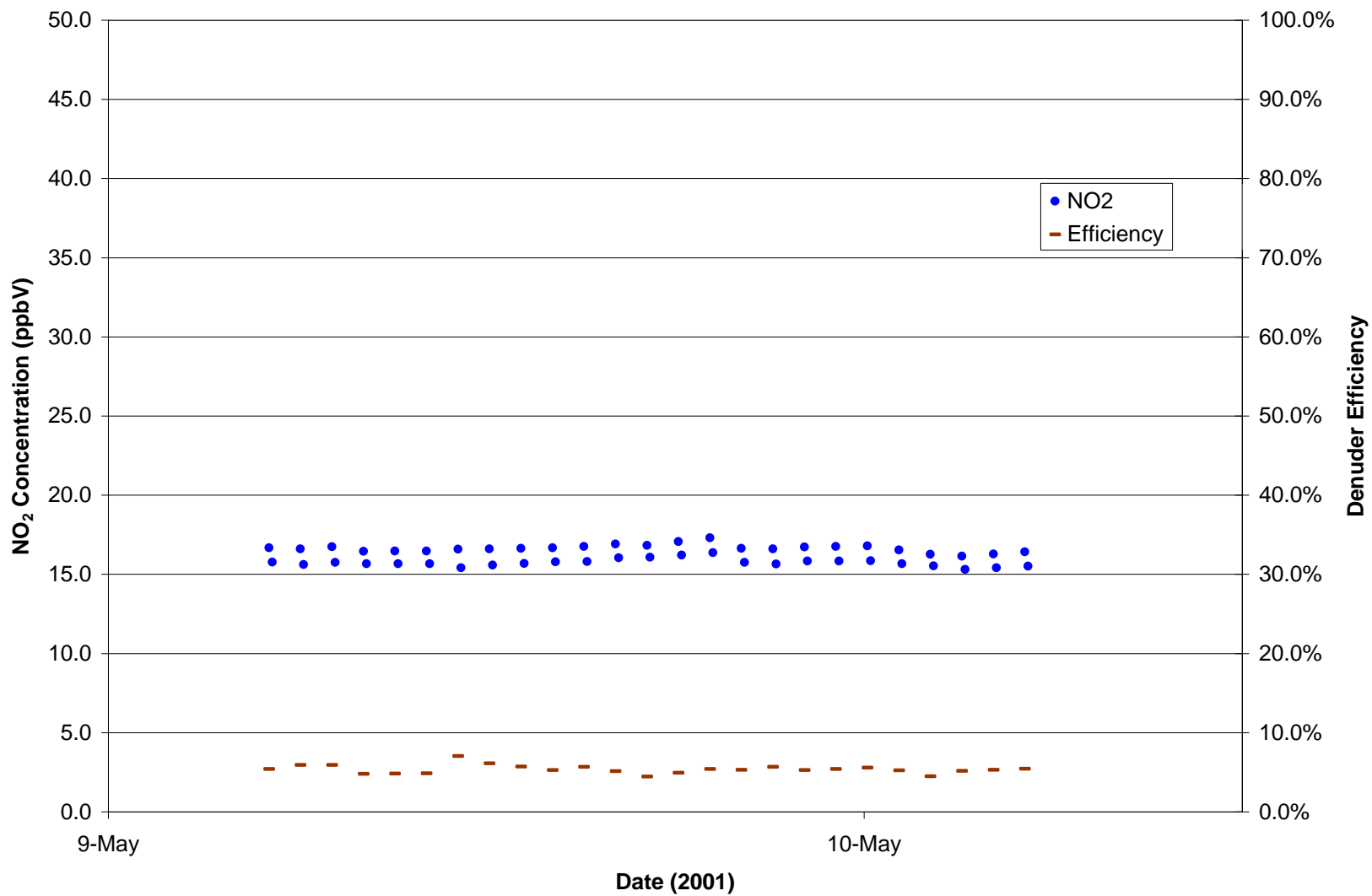

EPA Denuder Efficiency Evaluation Denuder 4 Experiment 10 (Low Humidity, Low NO2 Concentration)

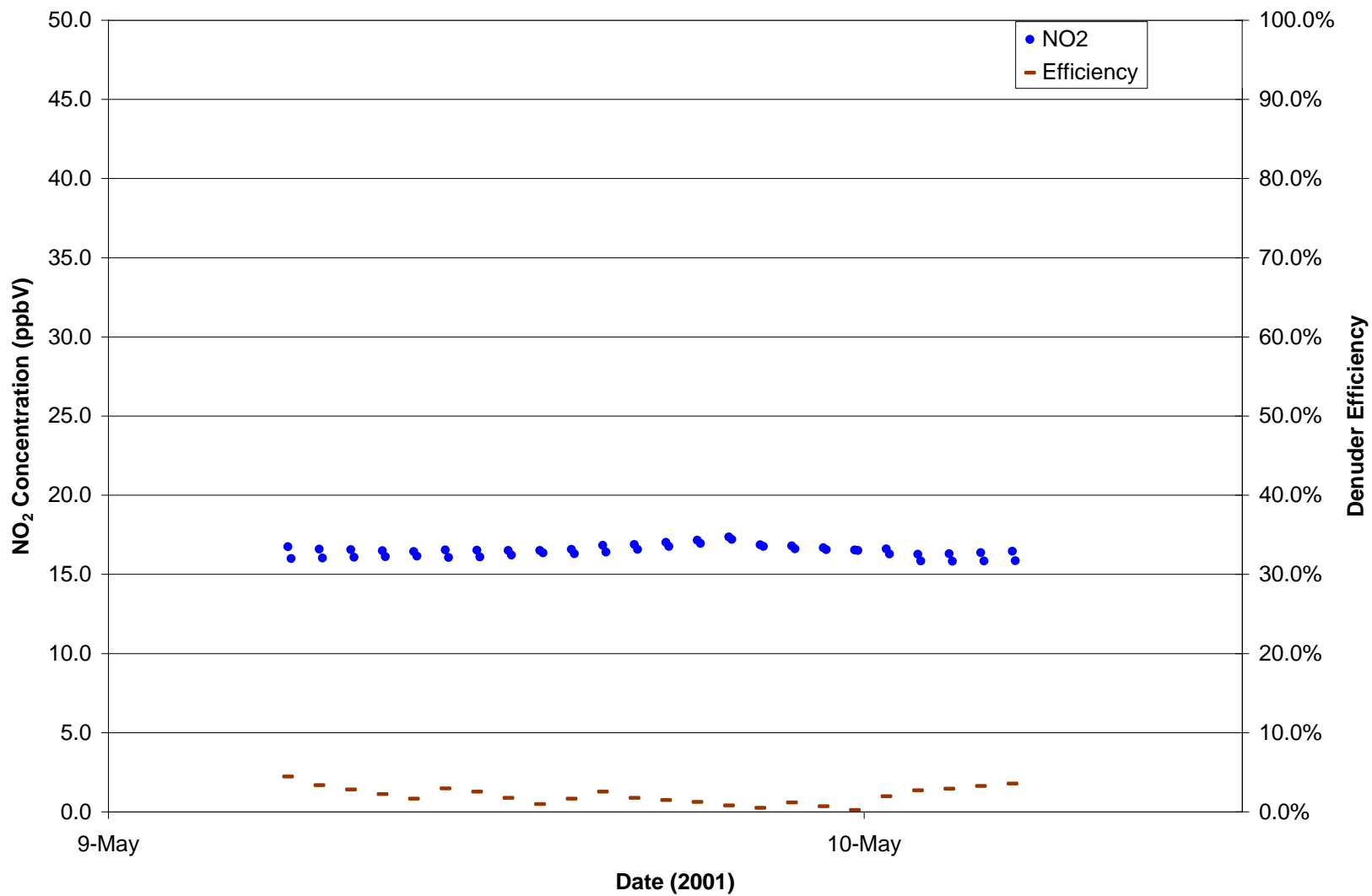

EPA Denuder Efficiency Evaluation Denuder 3
Experiment 10 (Low Humidity, Low NO2 Concentration)

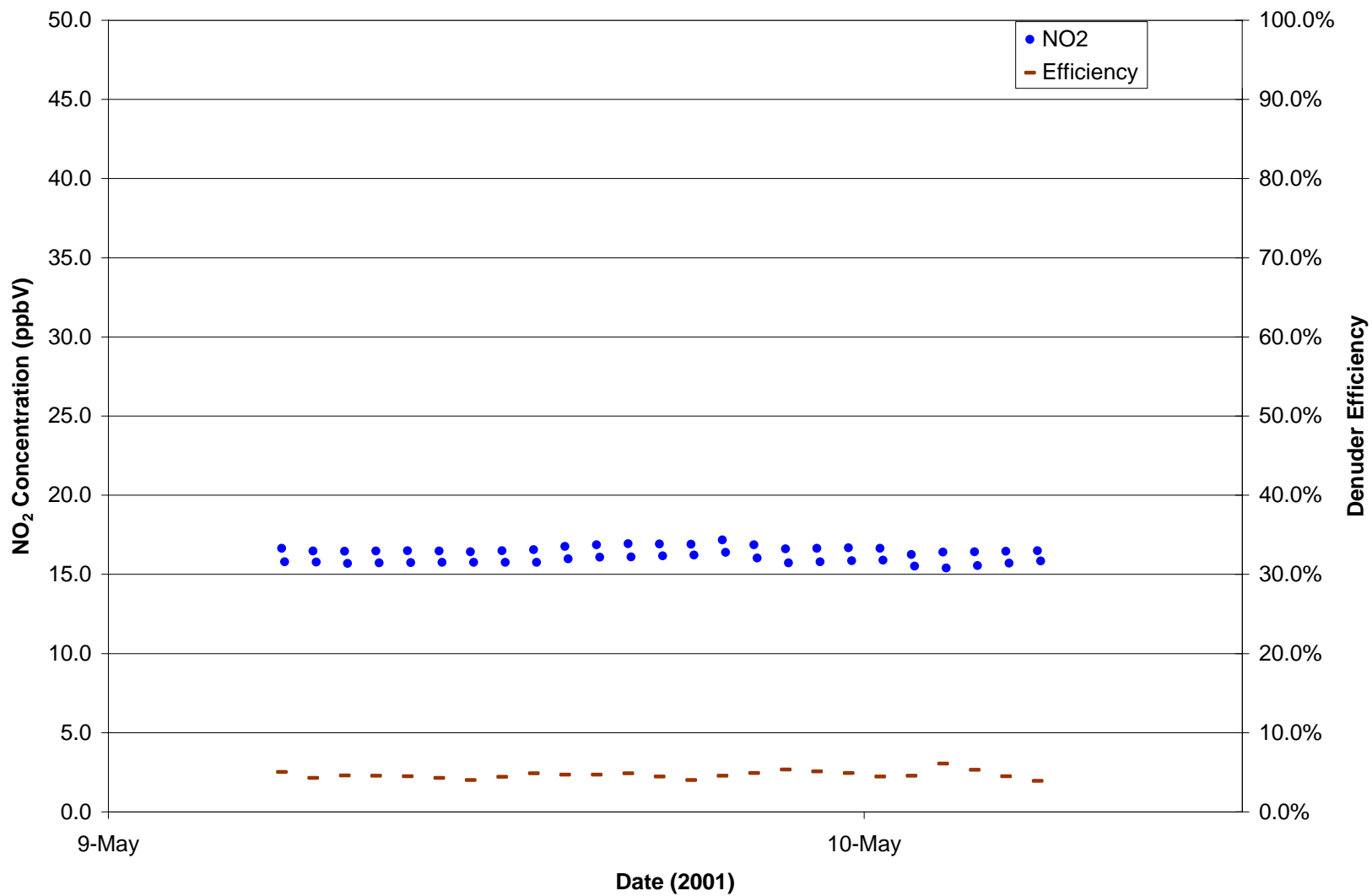

EPA Denuder Efficiency Evaluation Denuder 2 Experiment 10 (Low Humidity, Low NO2 Concentration)

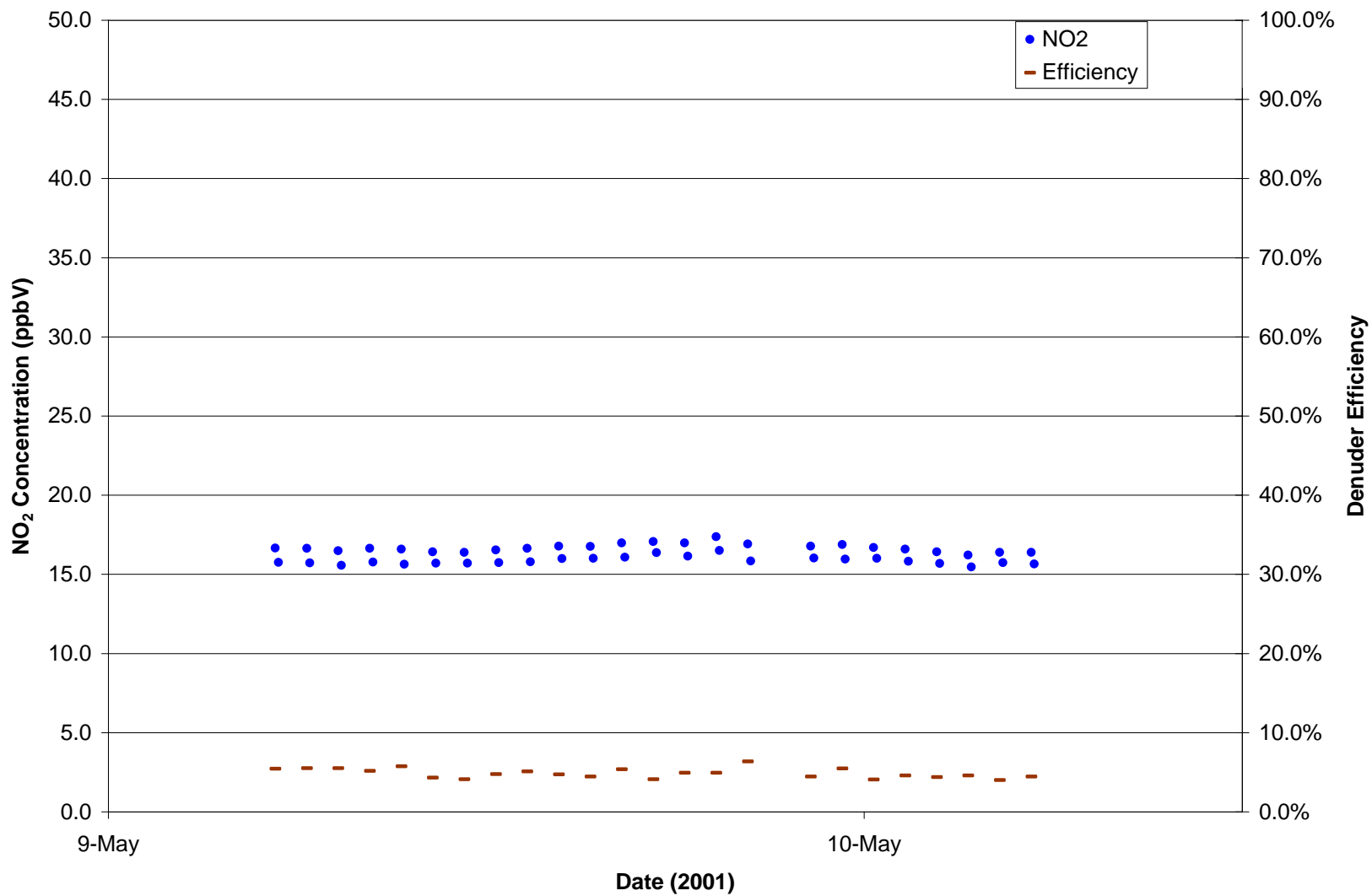

EPA Denuder Efficiency Evaluation Denuder 5
Experiment 10 (Low Humidity, Low NO2 Concentration)

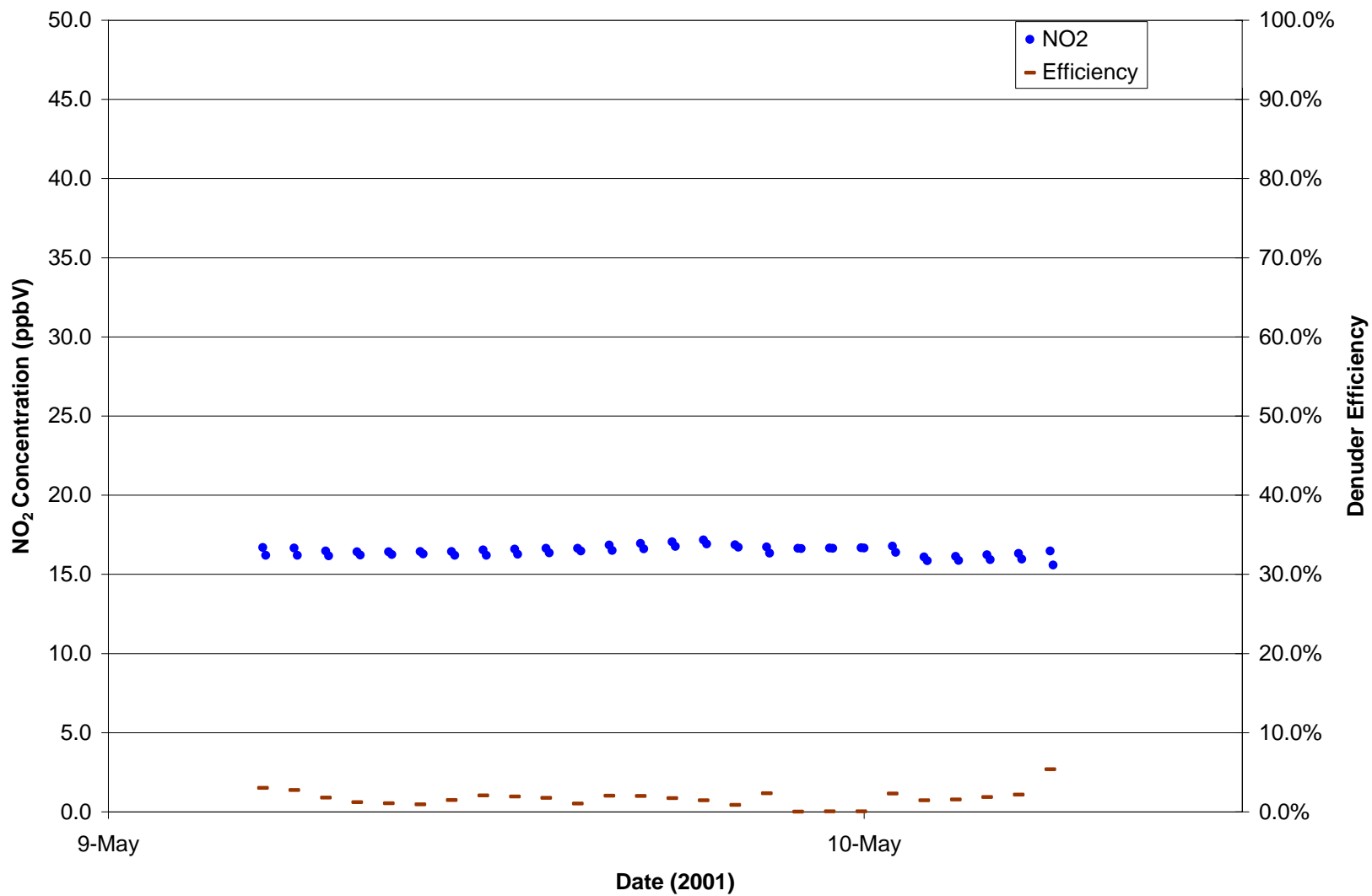

EPA Denuder Efficiency Evaluation Denuder 1
Experiment 11 (High Humidity, Low NO2 Concentration)

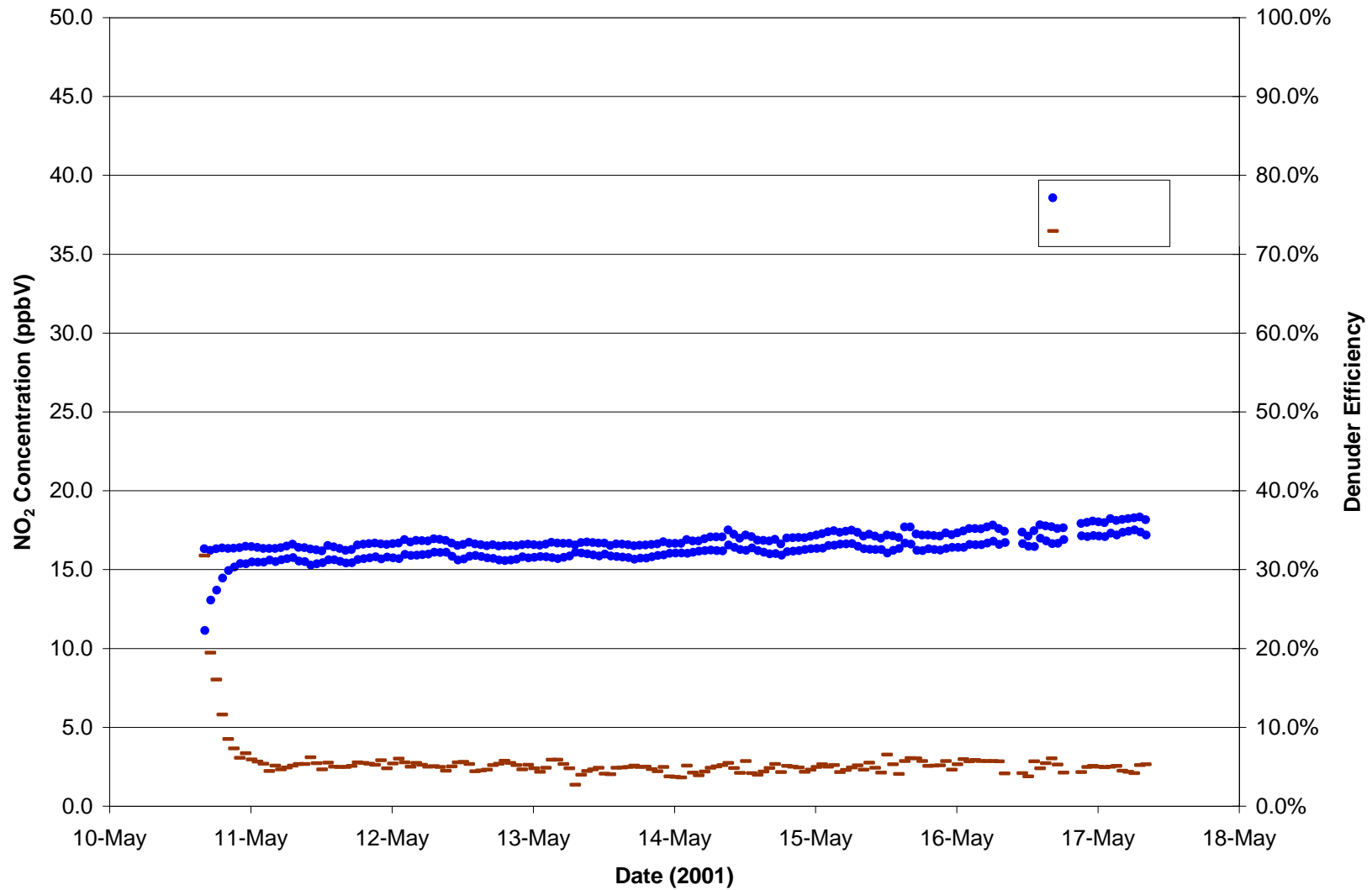

EPA Denuder Efficiency Evaluation Denuder 4 Experiment 11 (High Humidity, Low NO2 Concentration)

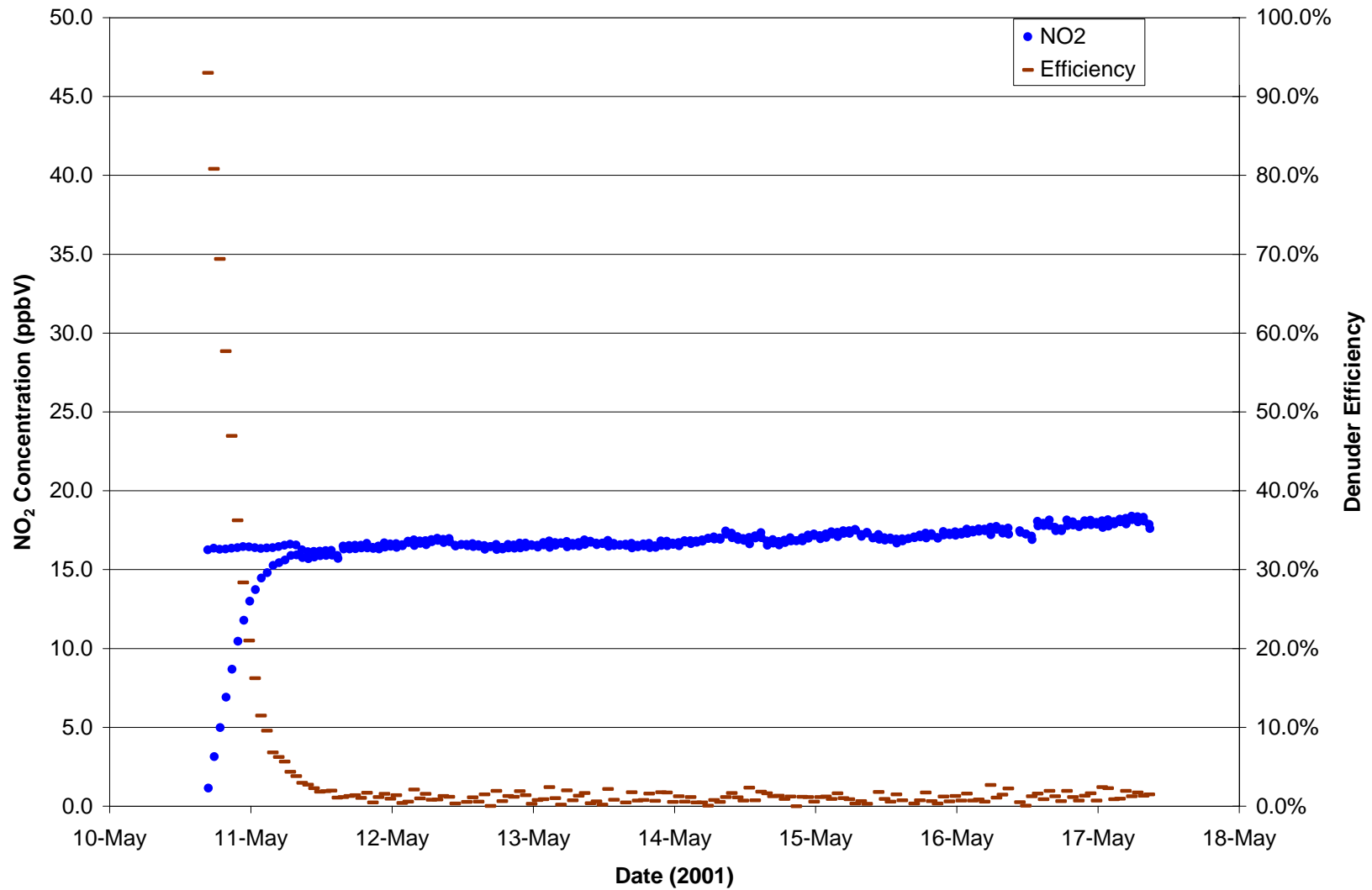

EPA Denuder Efficiency Evaluation Denuder 3
Experiment 11 (High Humidity, Low NO2 Concentration)

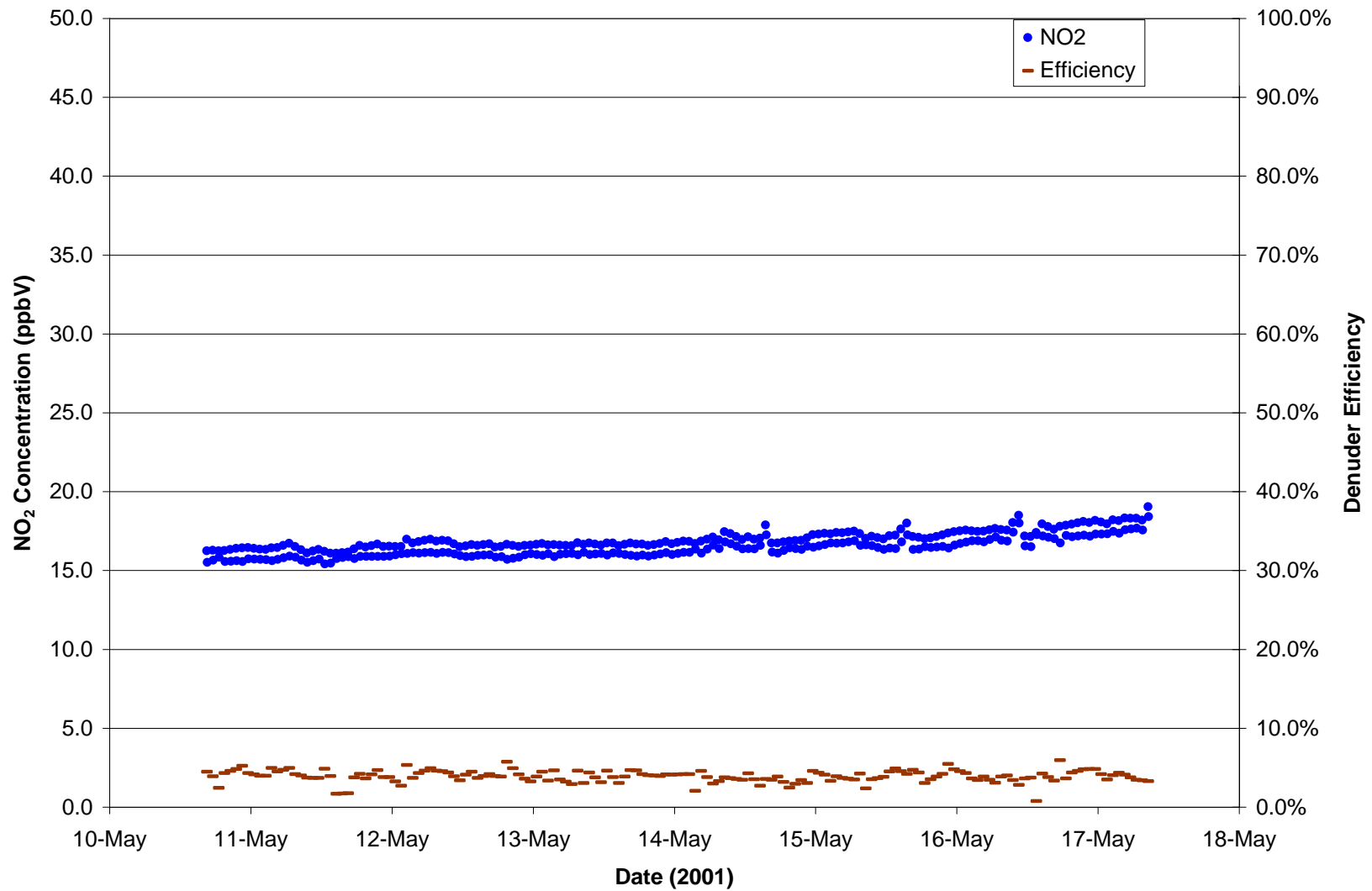

EPA Denuder Efficiency Evaluation Denuder 2
Experiment 11 (High Humidity, Low NO2 Concentration)

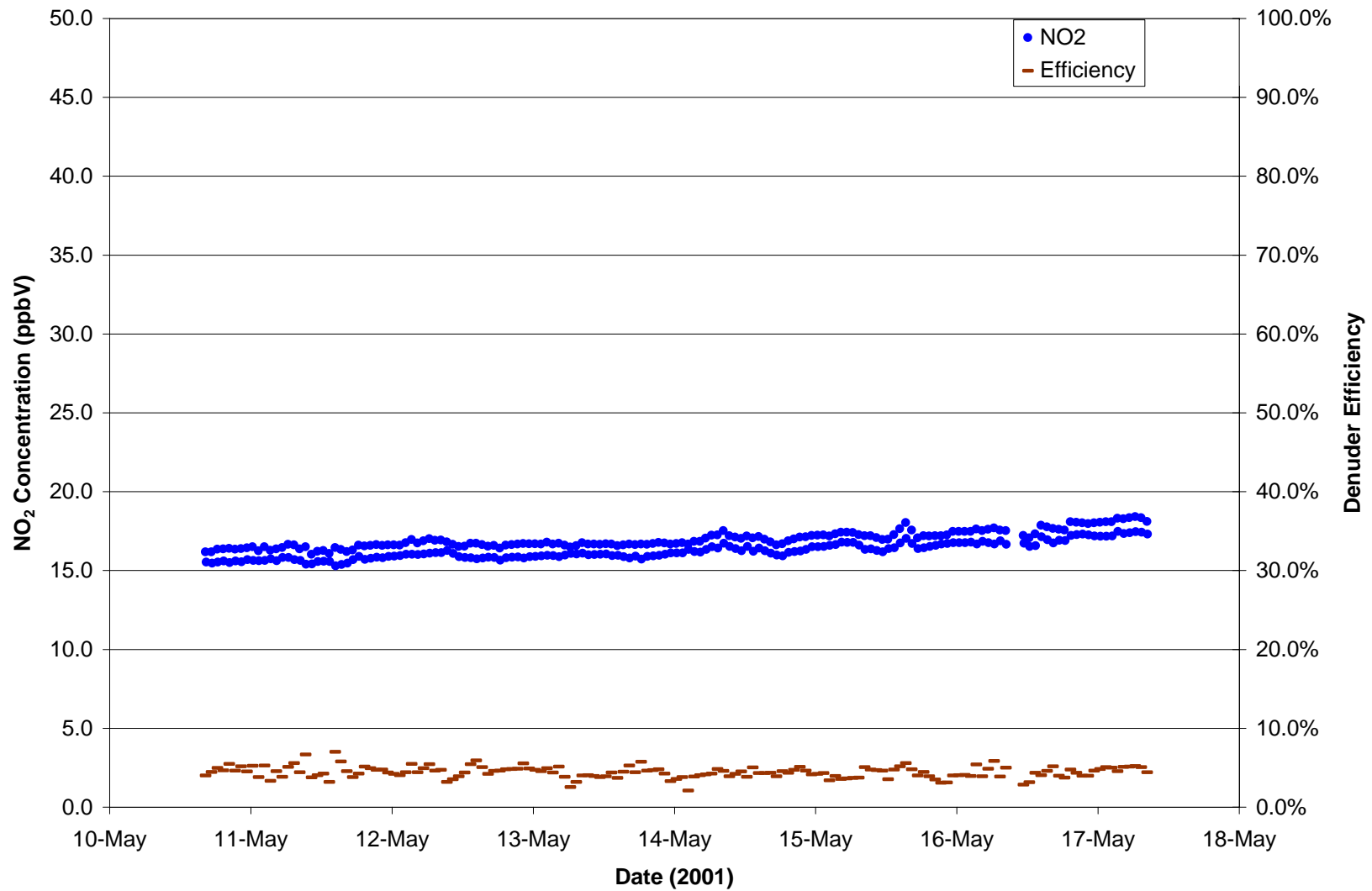

EPA Denuder Efficiency Evaluation Denuder 5 Experiment 11 (High Humidity, Low NO2 Concentration)

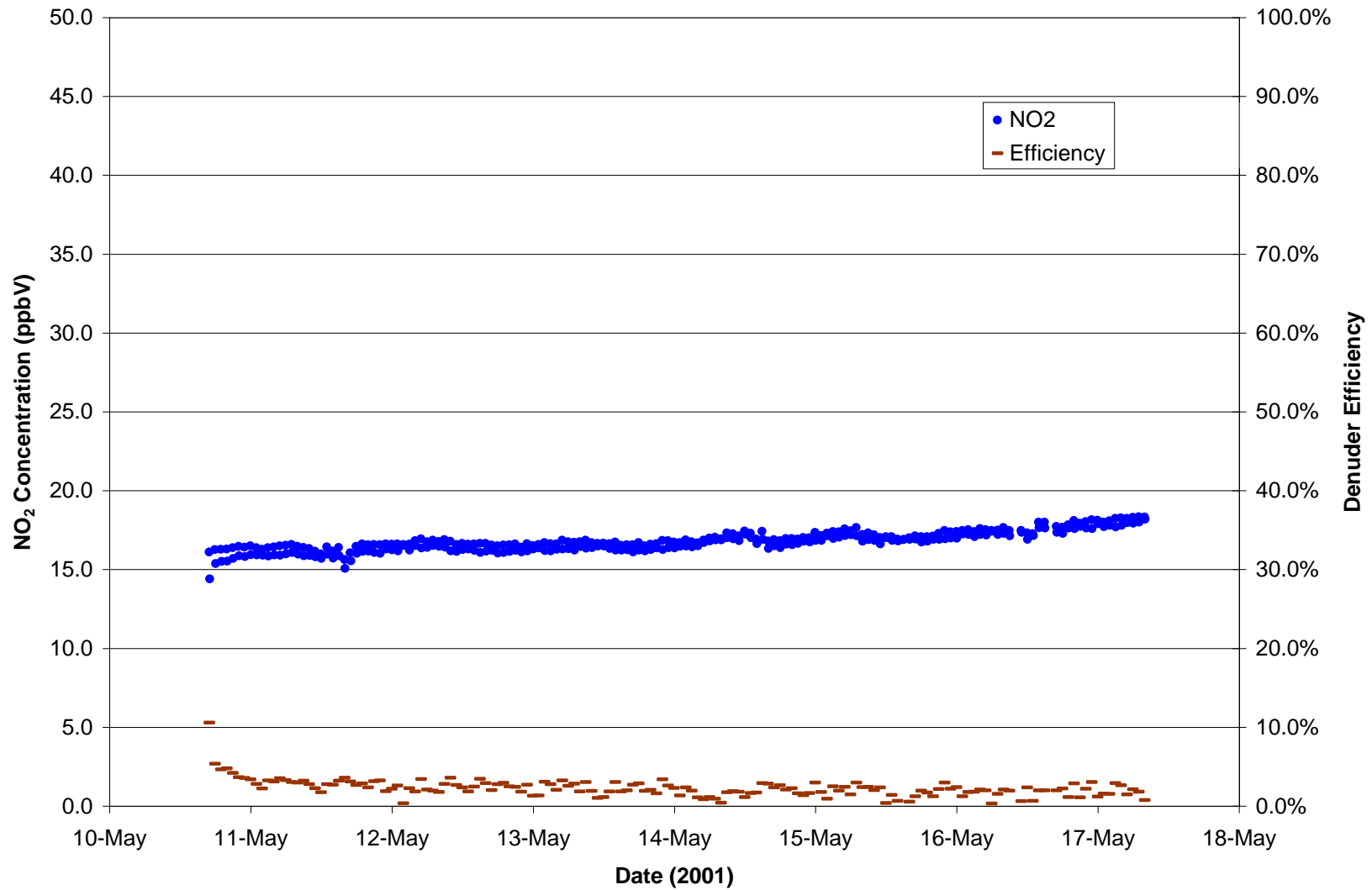

EPA Denuder Efficiency Evaluation Denuder 1 Experiment 12 (Low Humidity, High HONO Concentration)

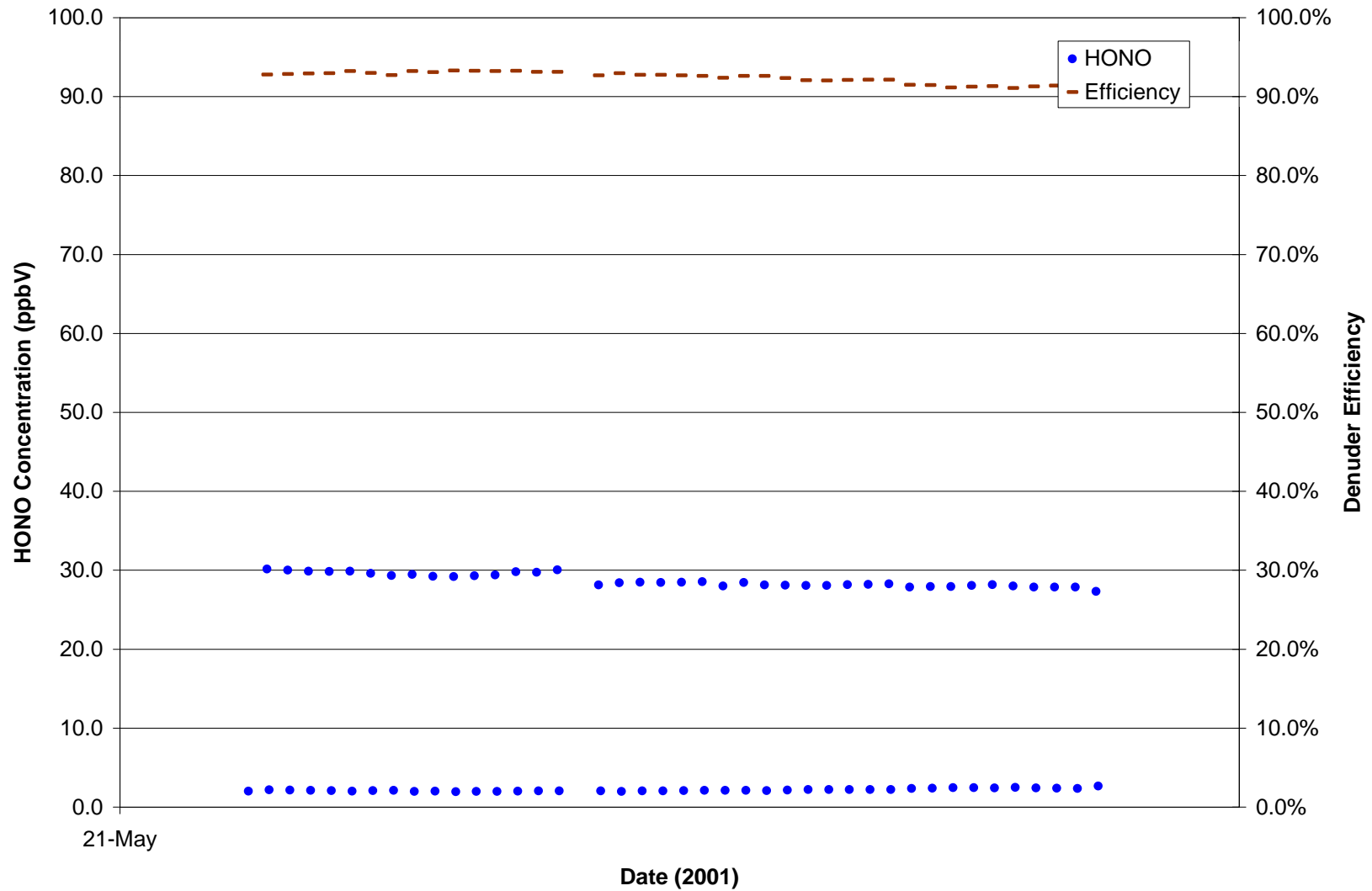

EPA Denuder Efficiency Evaluation Denuder 4 Experiment 12 (Low Humidity, High HONO Concentration)

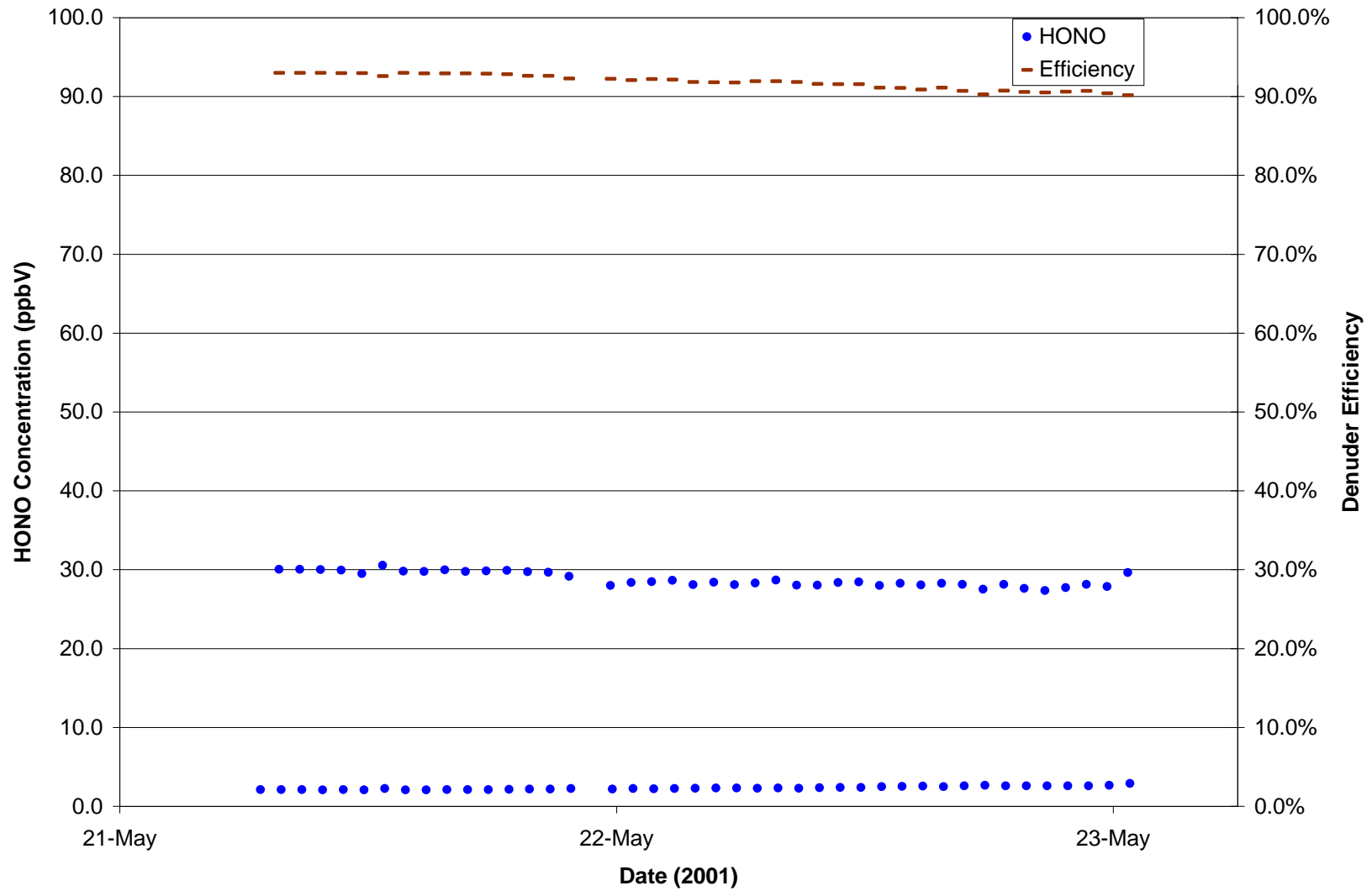

EPA Denuder Efficiency Evaluation Denuder 3 Experiment 12 (Low Humidity, High HONO Concentration)

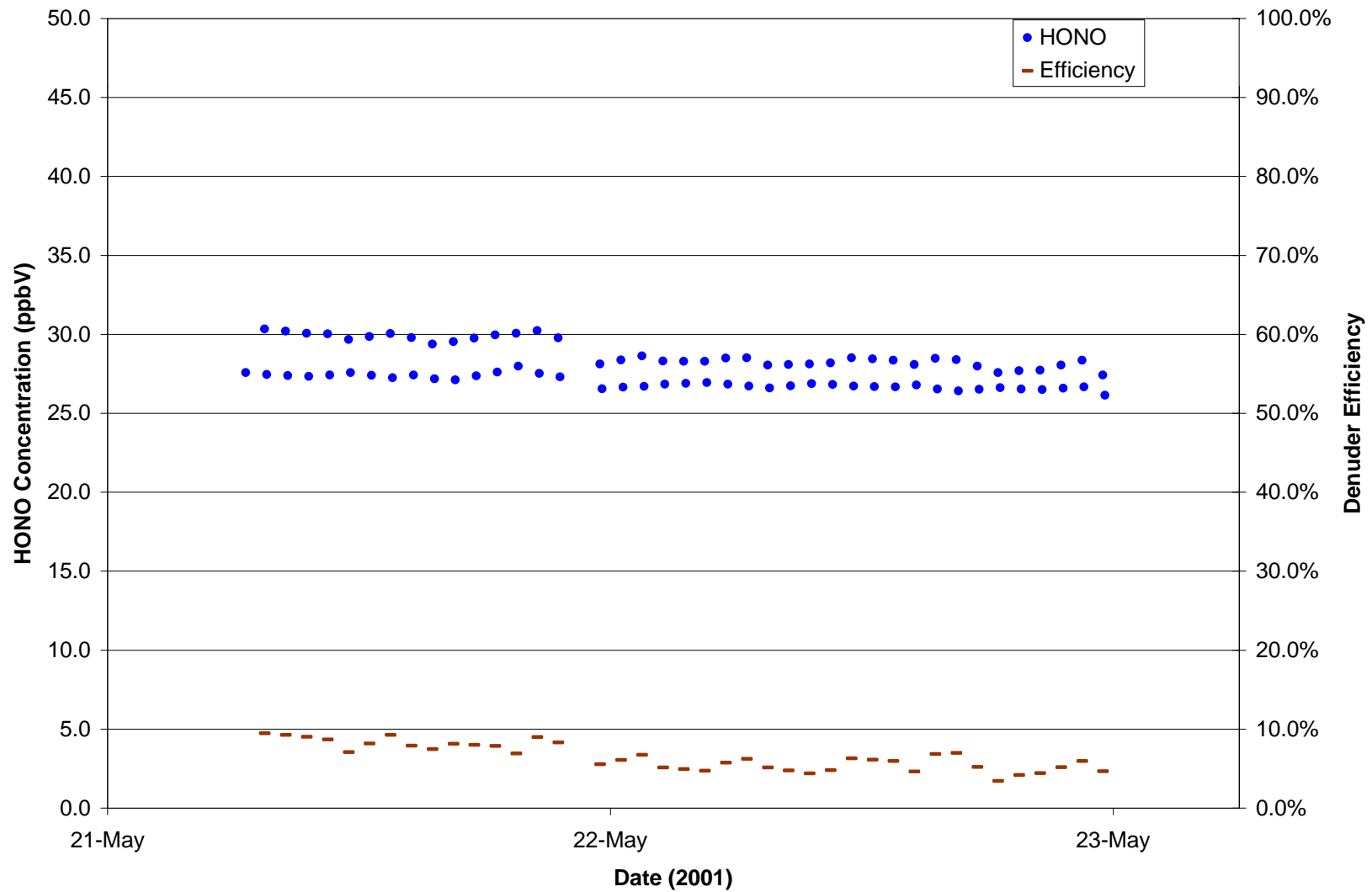

EPA Denuder Efficiency Evaluation Denuder 2 Experiment 12 (Low Humidity, High HONO Concentration)

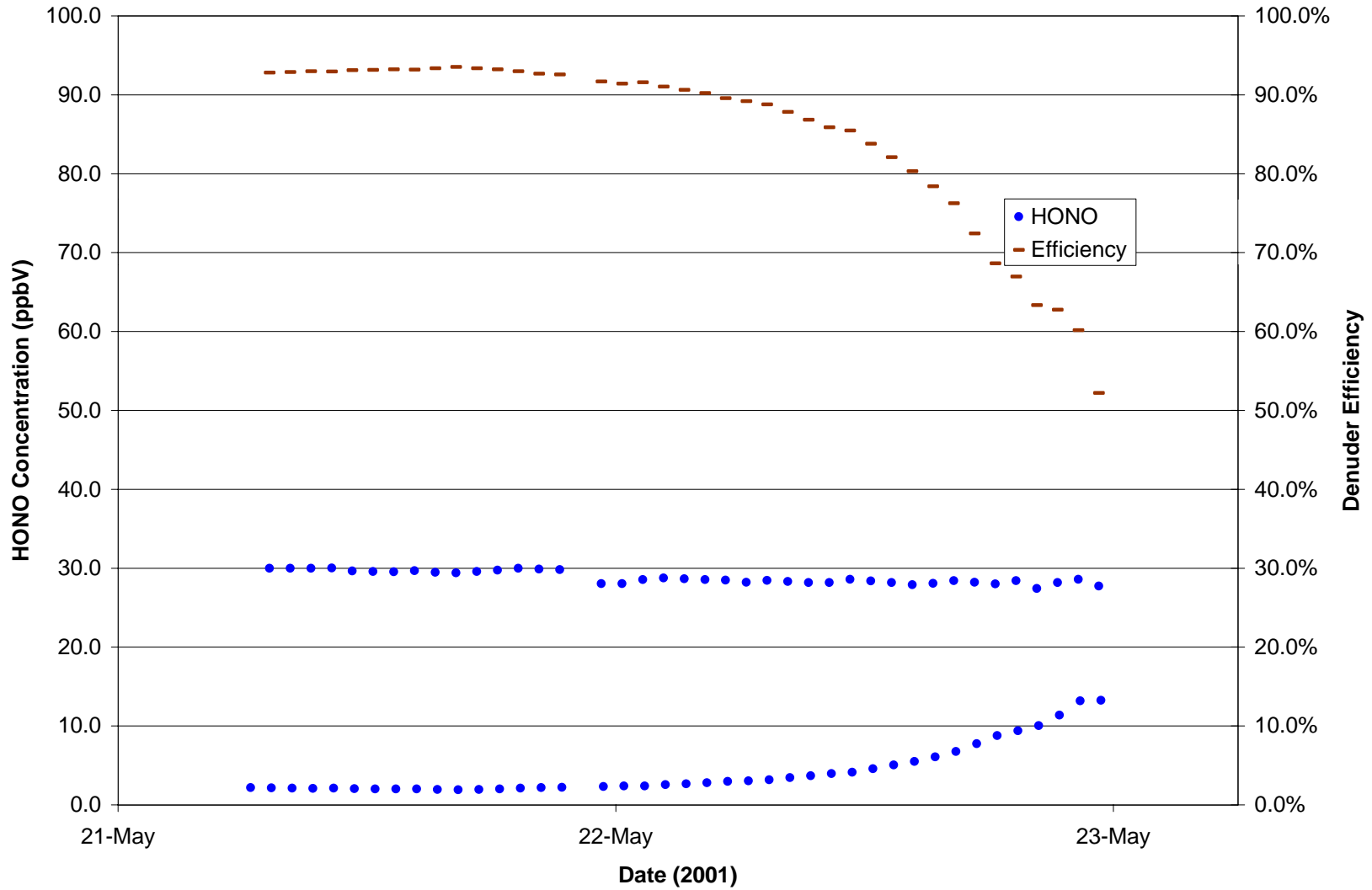

EPA Denuder Efficiency Evaluation Denuder 5 Experiment 12 (Low Humidity, High HONO Concentration)

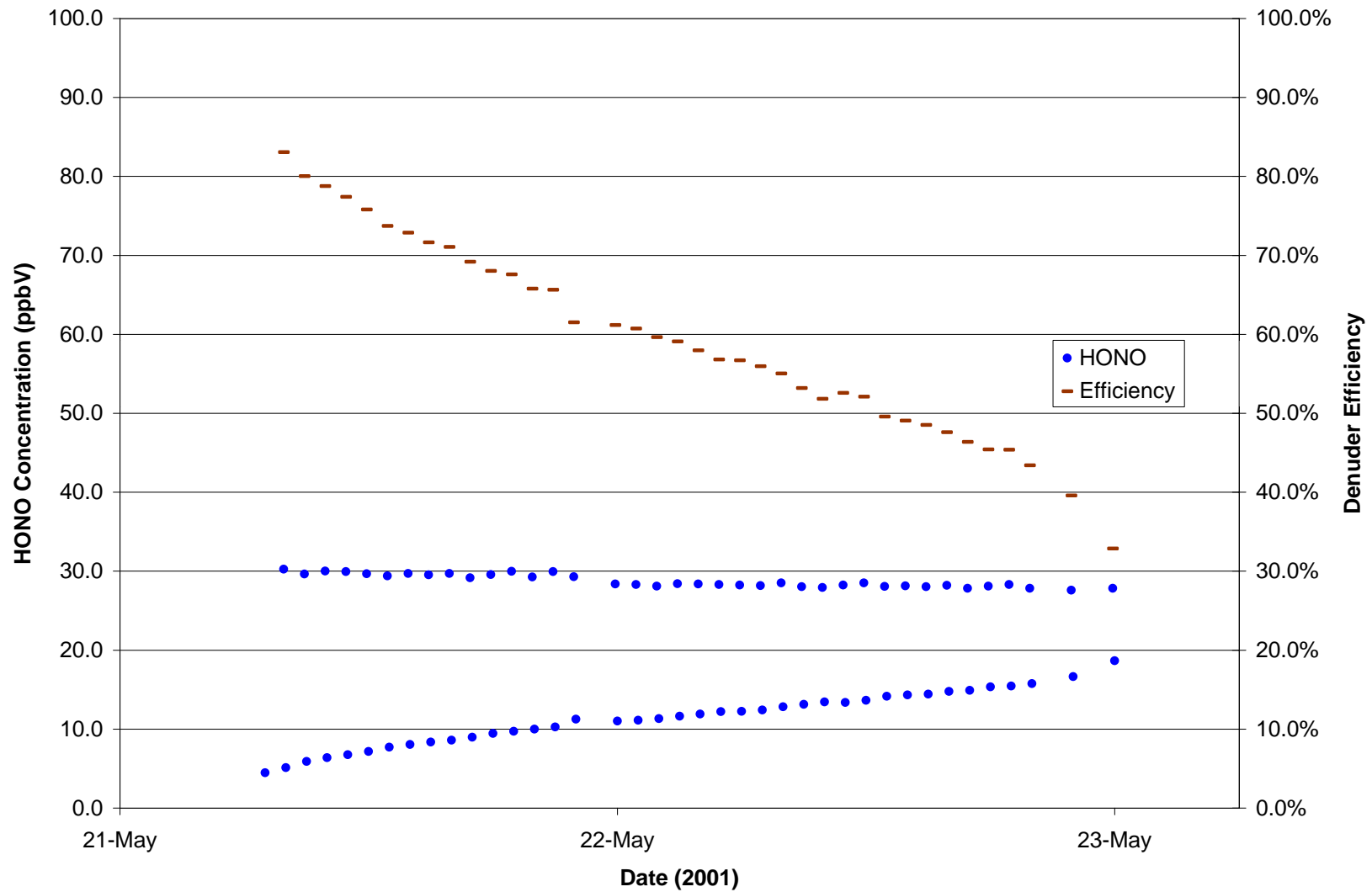

EPA Denuder Efficiency Evaluation Denuder 1 Experiment 13 (High Humidity, High HONO Concentration)

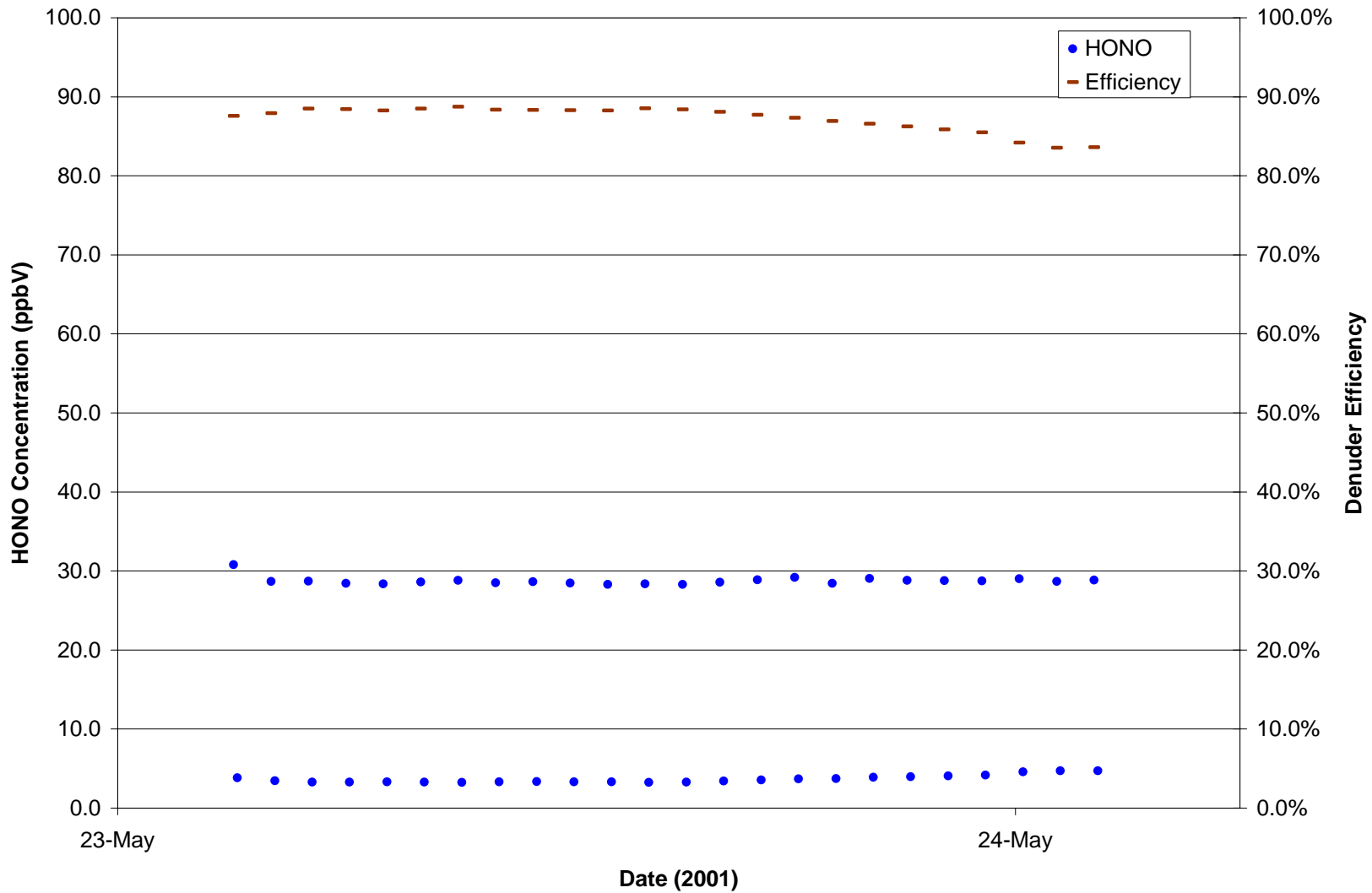

EPA Denuder Efficiency Evaluation Denuder 4
Experiment 13 (High Humidity, High HONO Concentration)

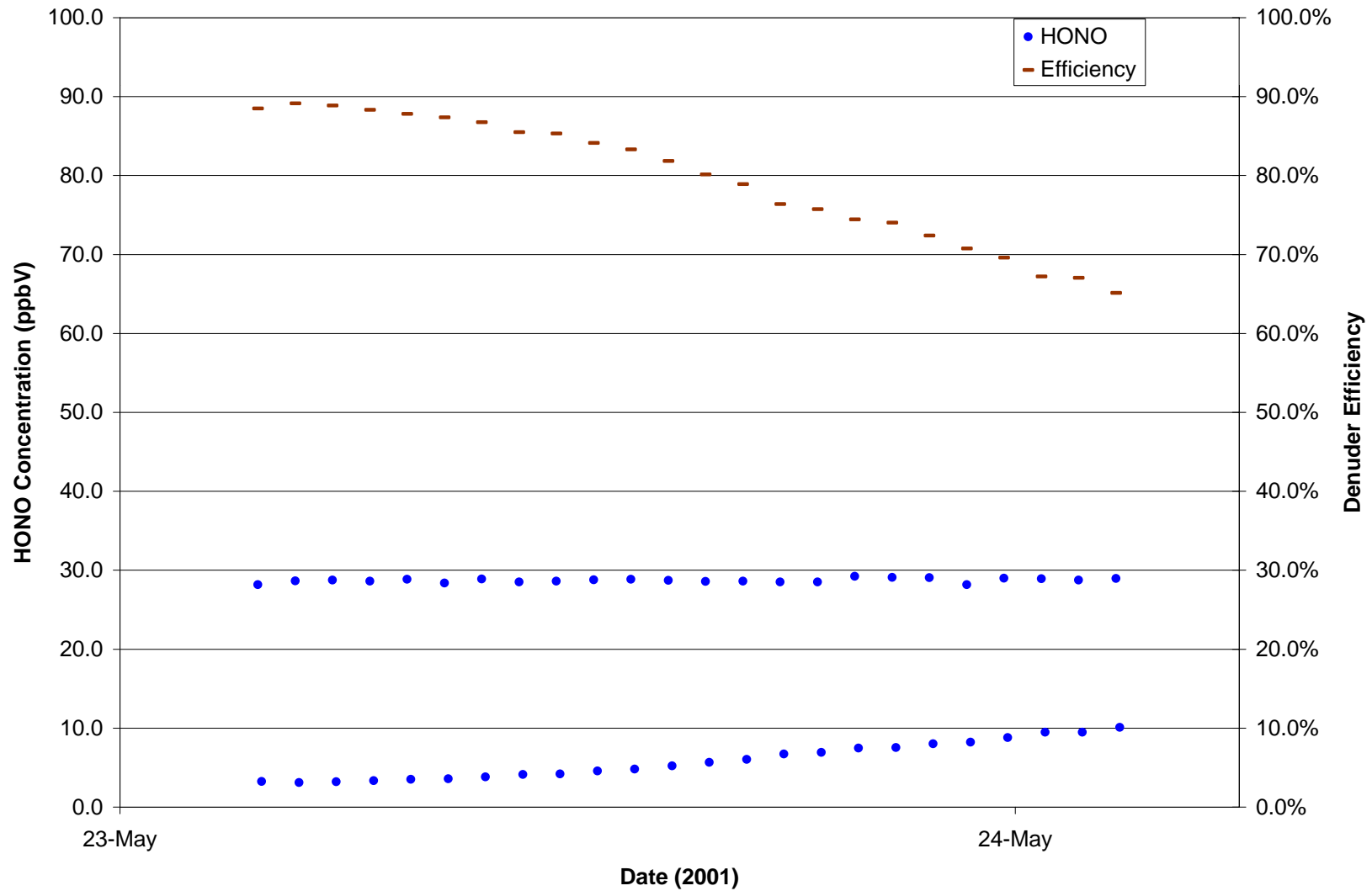

EPA Denuder Efficiency Evaluation Denuder 3 Experiment 13 (High Humidity, High HONO Concentration)

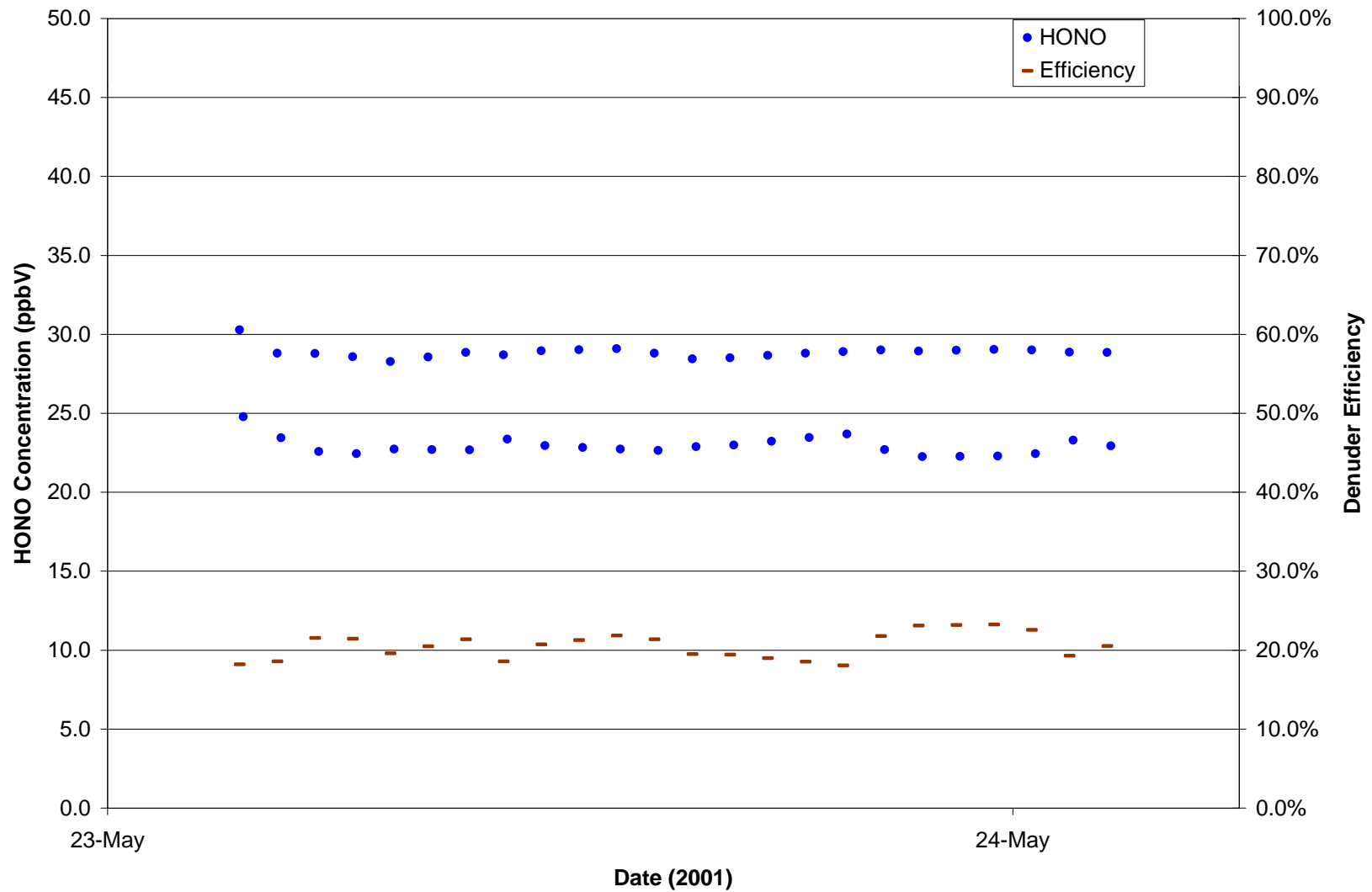

EPA Denuder Efficiency Evaluation Denuder 2 Experiment 13 (High Humidity, High HONO Concentration)

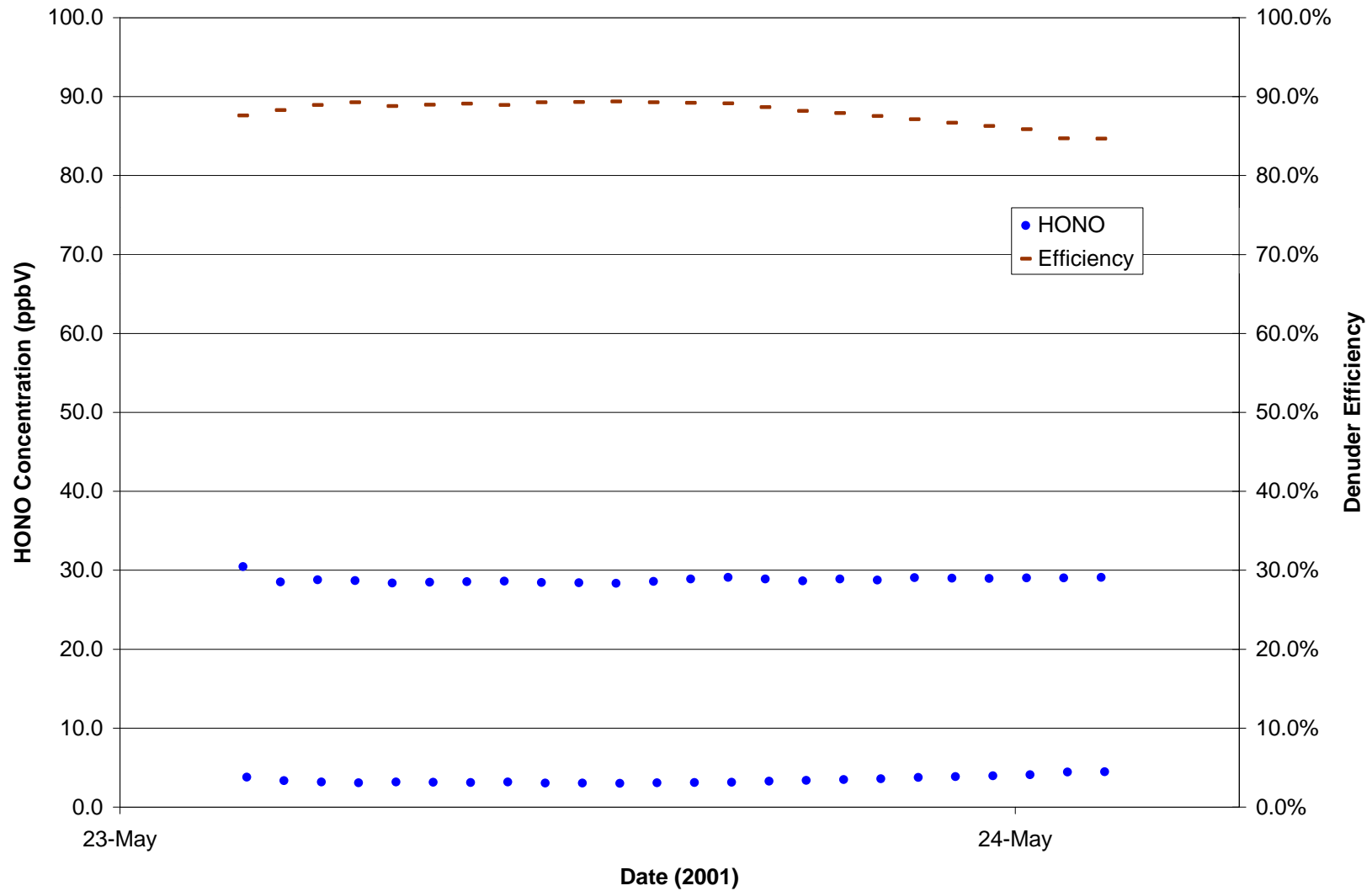

EPA Denuder Efficiency Evaluation Denuder 5 Experiment 13 (High Humidity, High HONO Concentration)

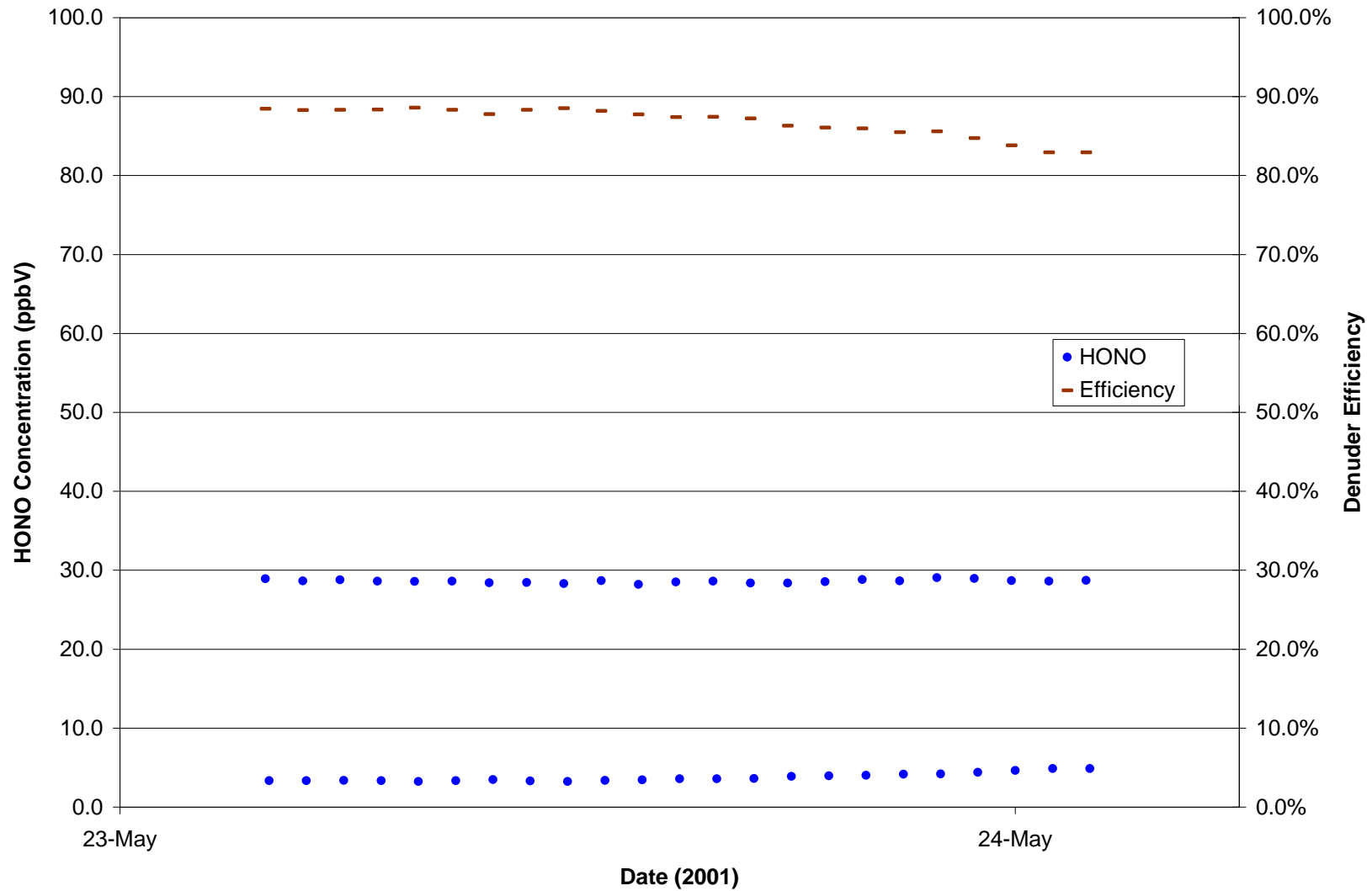

EPA Denuder Efficiency Evaluation Denuder 1 Experiment 14 (High Humidity, High HONO Concentration)

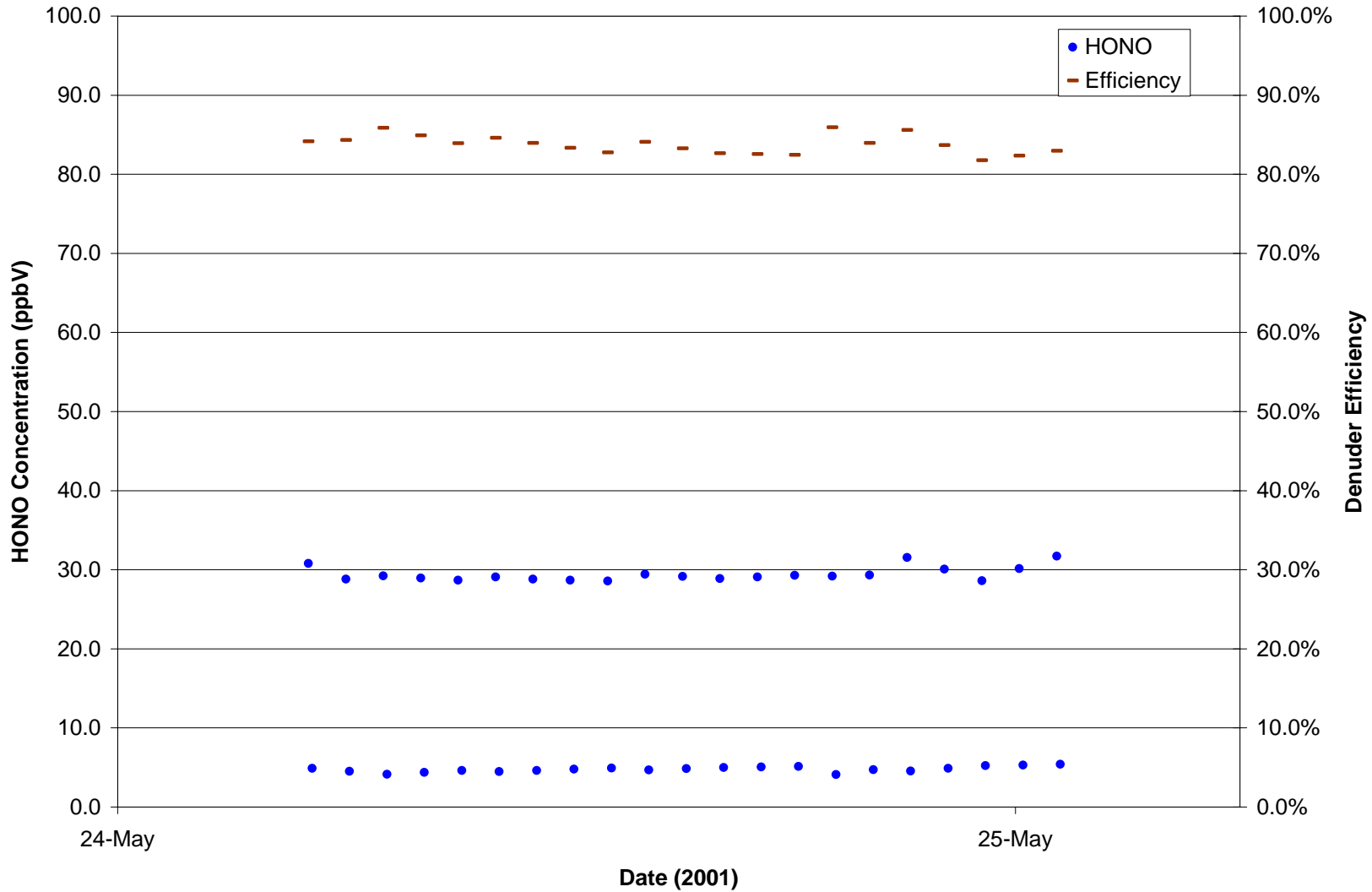

EPA Denuder Efficiency Evaluation Denuder 4 Experiment 14 (High Humidity, High HONO Concentration)

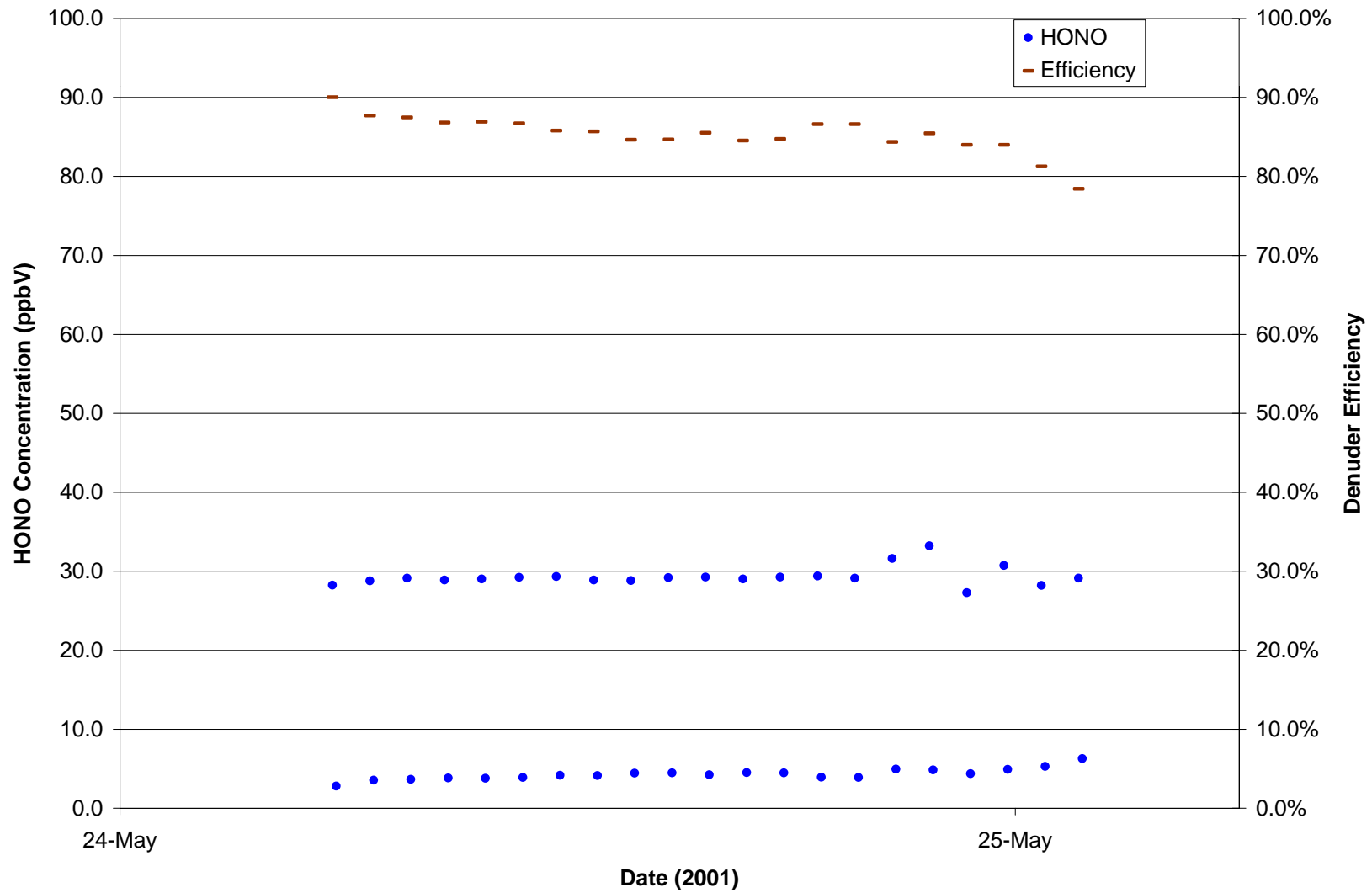

EPA Denuder Efficiency Evaluation Denuder 3
Experiment 14 (High Humidity, High HONO Concentration)

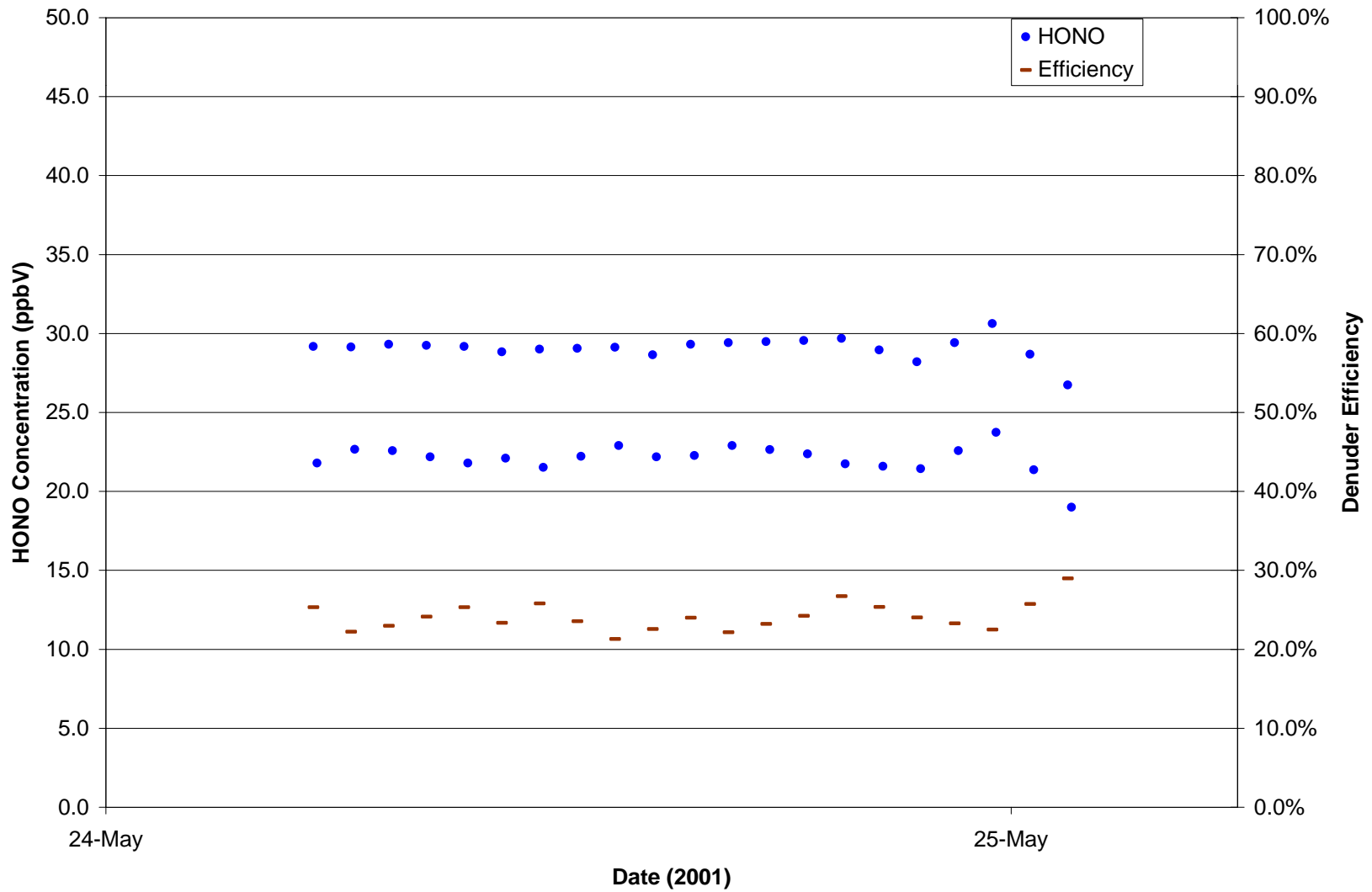

**EPA Denuder Efficiency Evaluation Denuder 2
Experiment 14 (High Humidity, High HONO Concentration)**

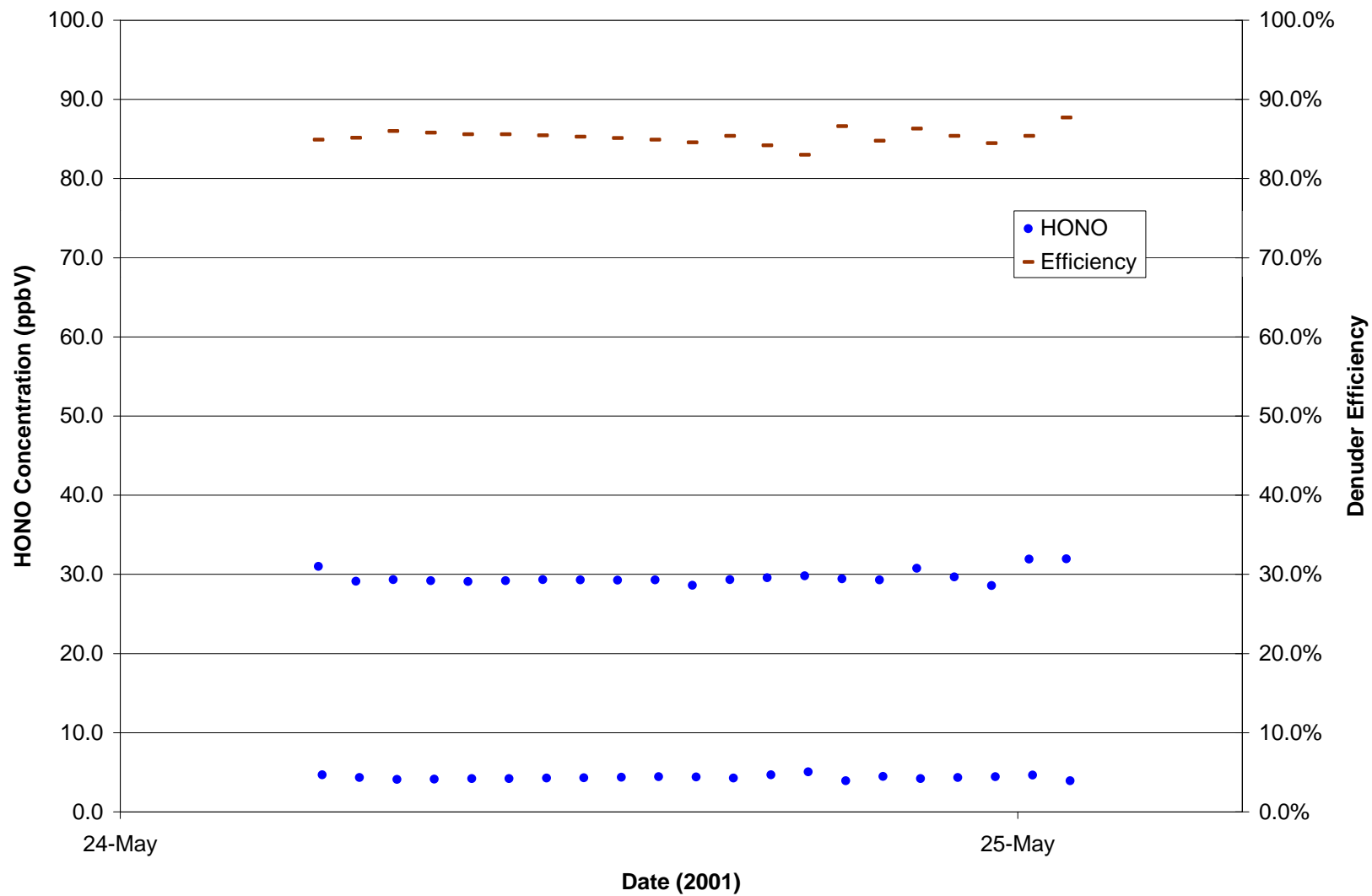

EPA Denuder Efficiency Evaluation Denuder 5 Experiment 14 (High Humidity, High HONO Concentration)

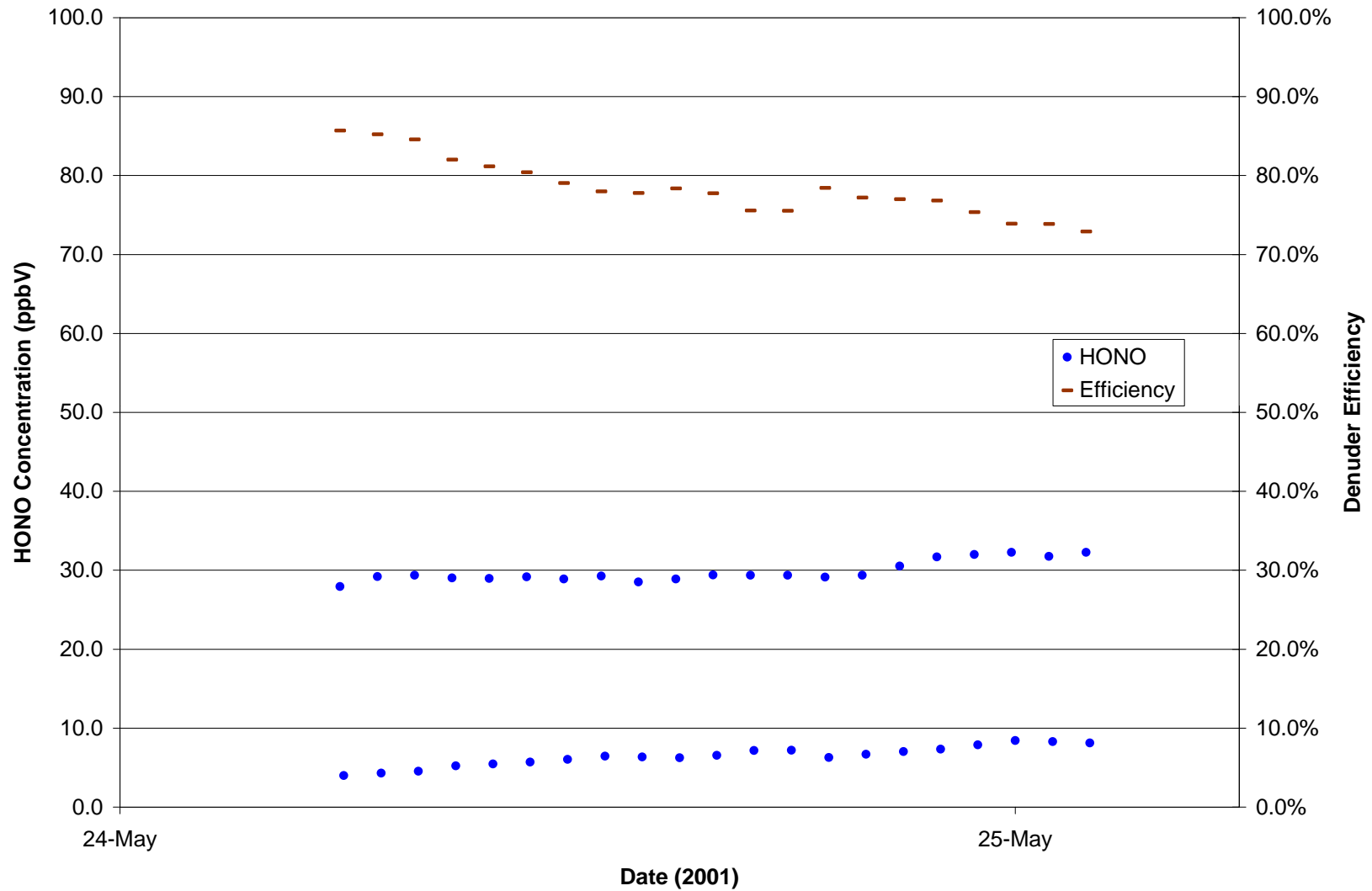

EPA Denuder Efficiency Evaluation Denuder 4 Experiment 15 (High Humidity, Low HONO Concentration)

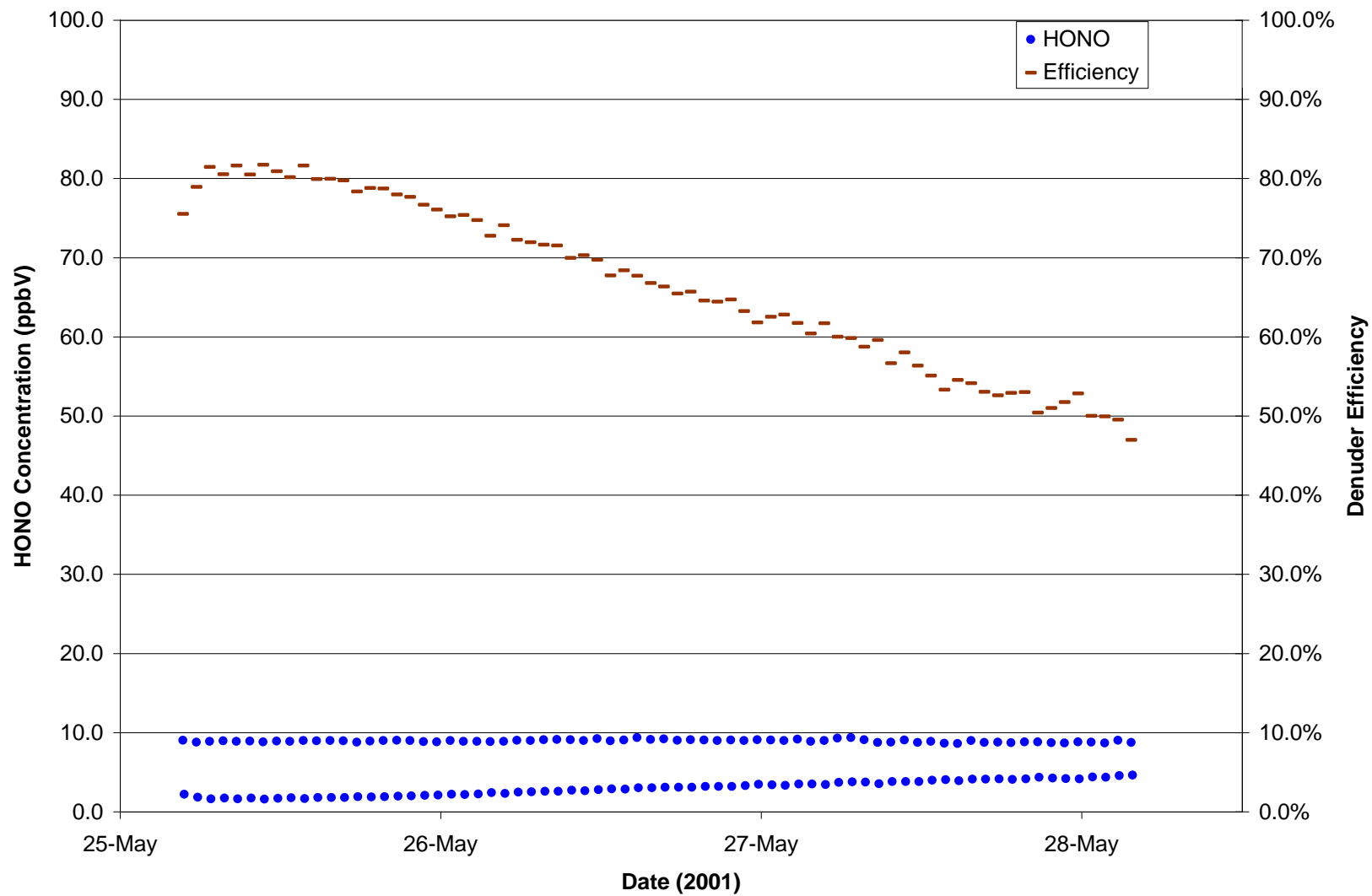

EPA Denuder Efficiency Evaluation Denuder 5
Experiment 15 (High Humidity, Low HONO Concentration)

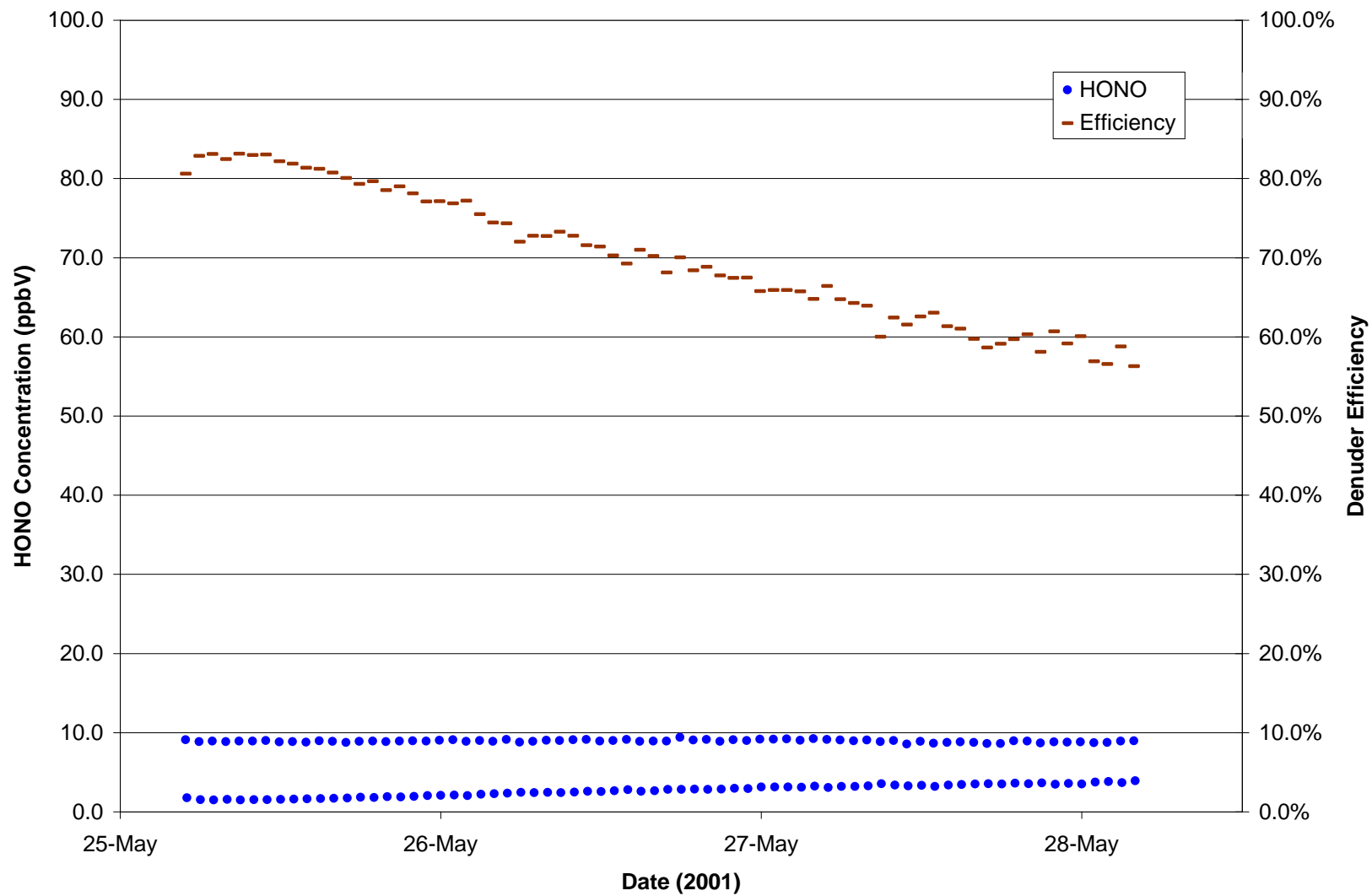

EPA Denuder Efficiency Evaluation Denuder 1
Experiment 16 (Low Humidity, Low HONO Concentration)

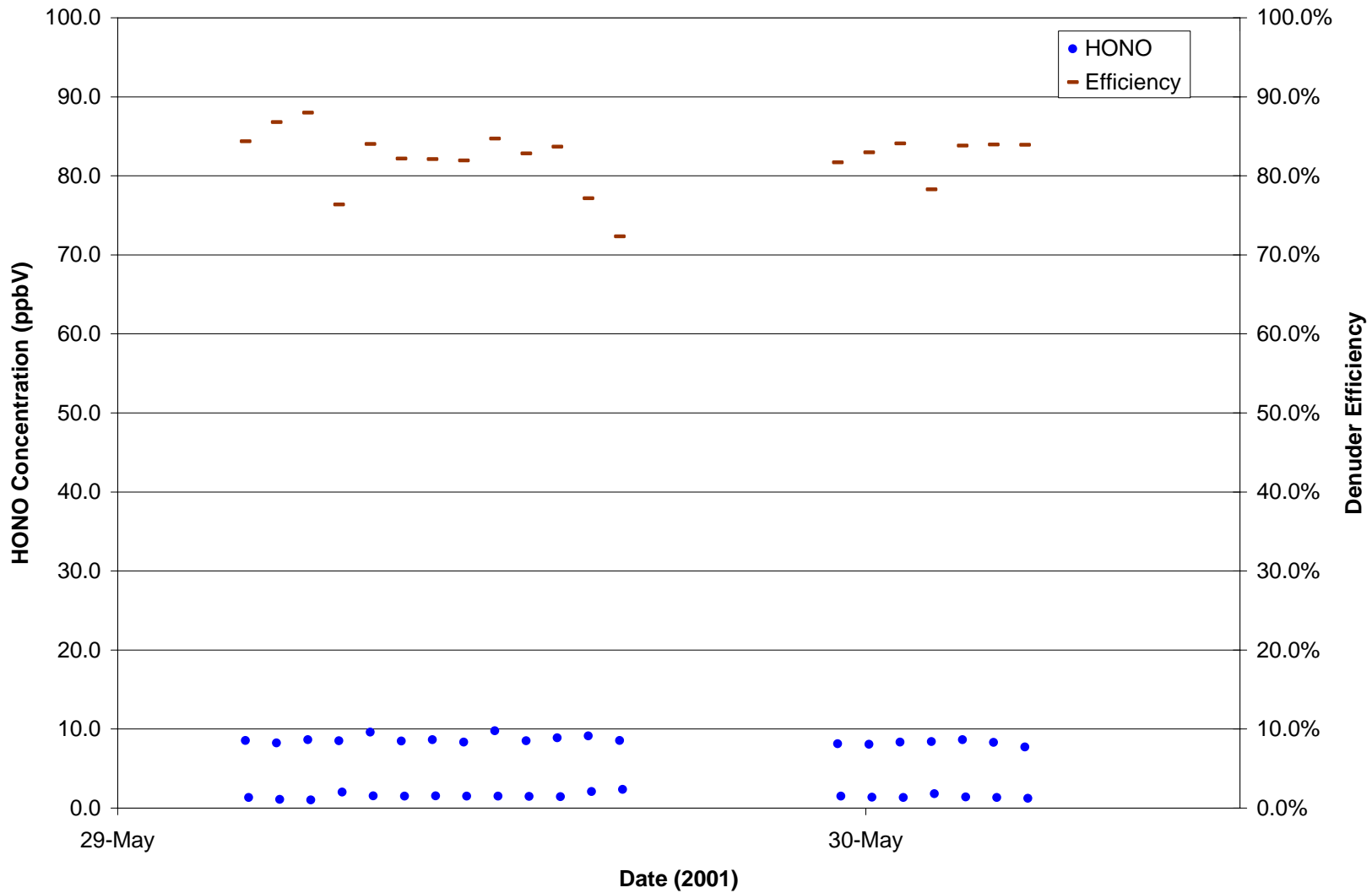

EPA Denuder Efficiency Evaluation Denuder 4
Experiment 16 (Low Humidity, Low HONO Concentration)

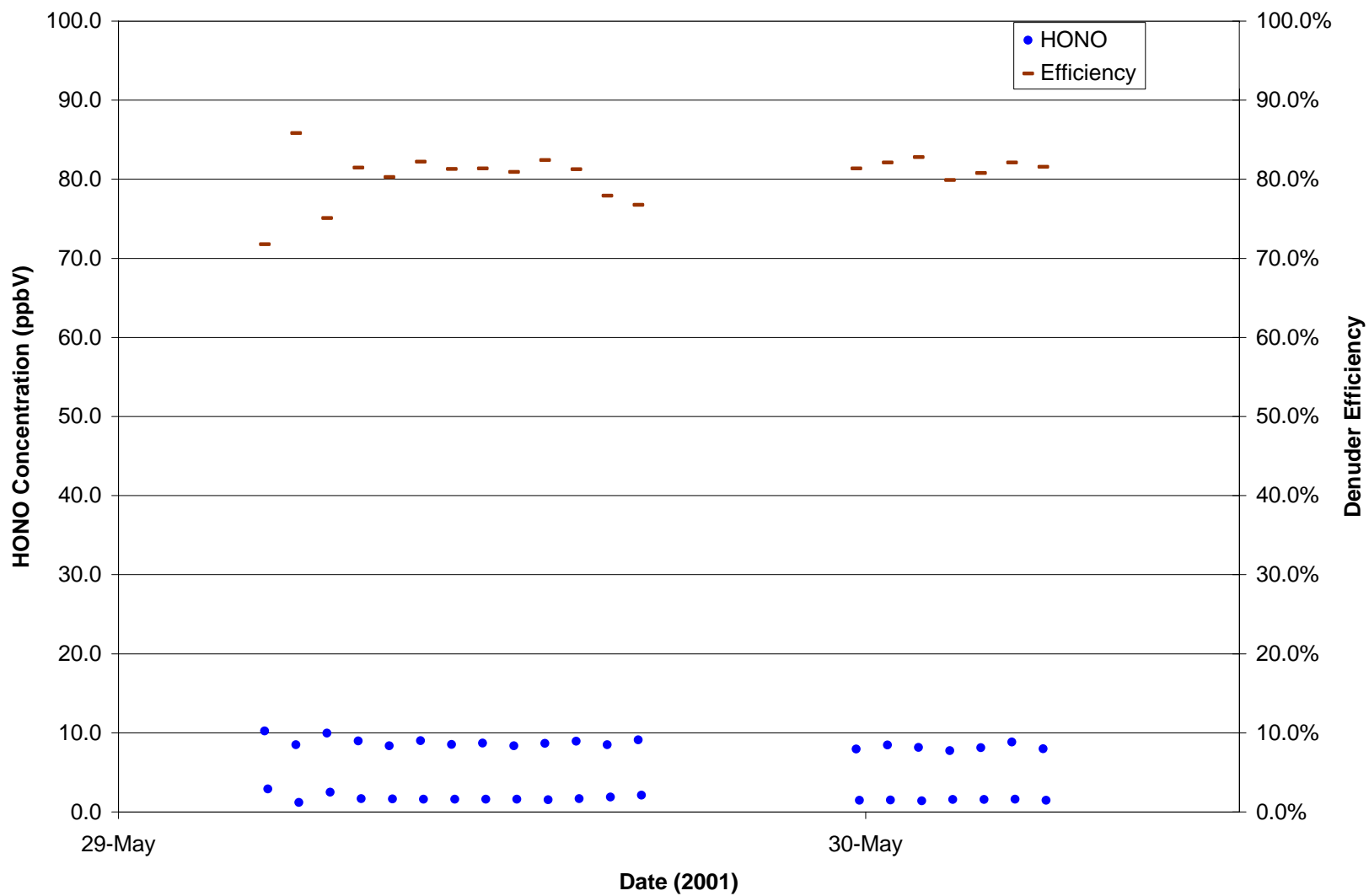

EPA Denuder Efficiency Evaluation Denuder 3
Experiment 16 (Low Humidity, Low HONO Concentration)

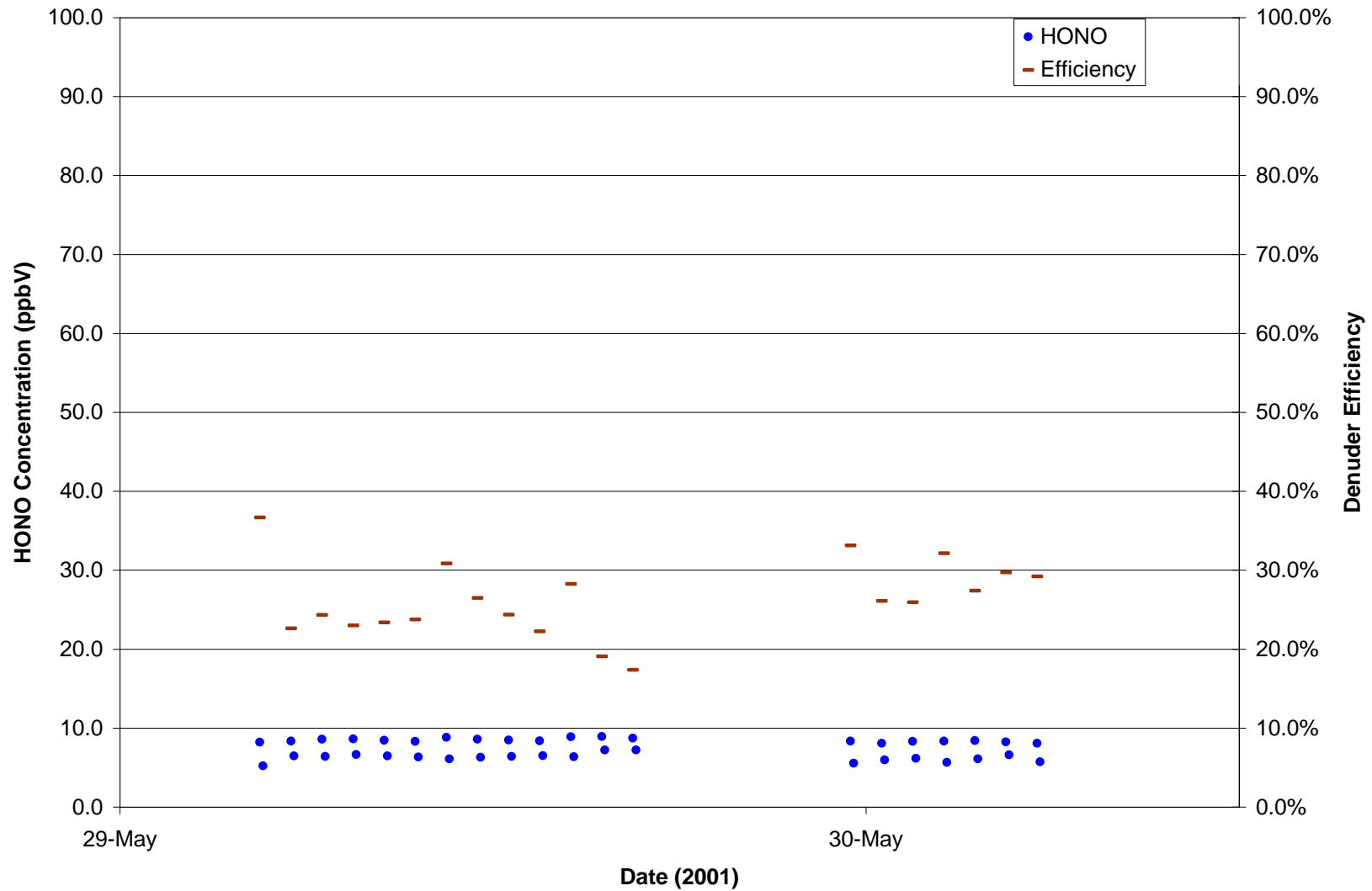

EPA Denuder Efficiency Evaluation Denuder 2 Experiment 16 (Low Humidity, Low HONO Concentration)

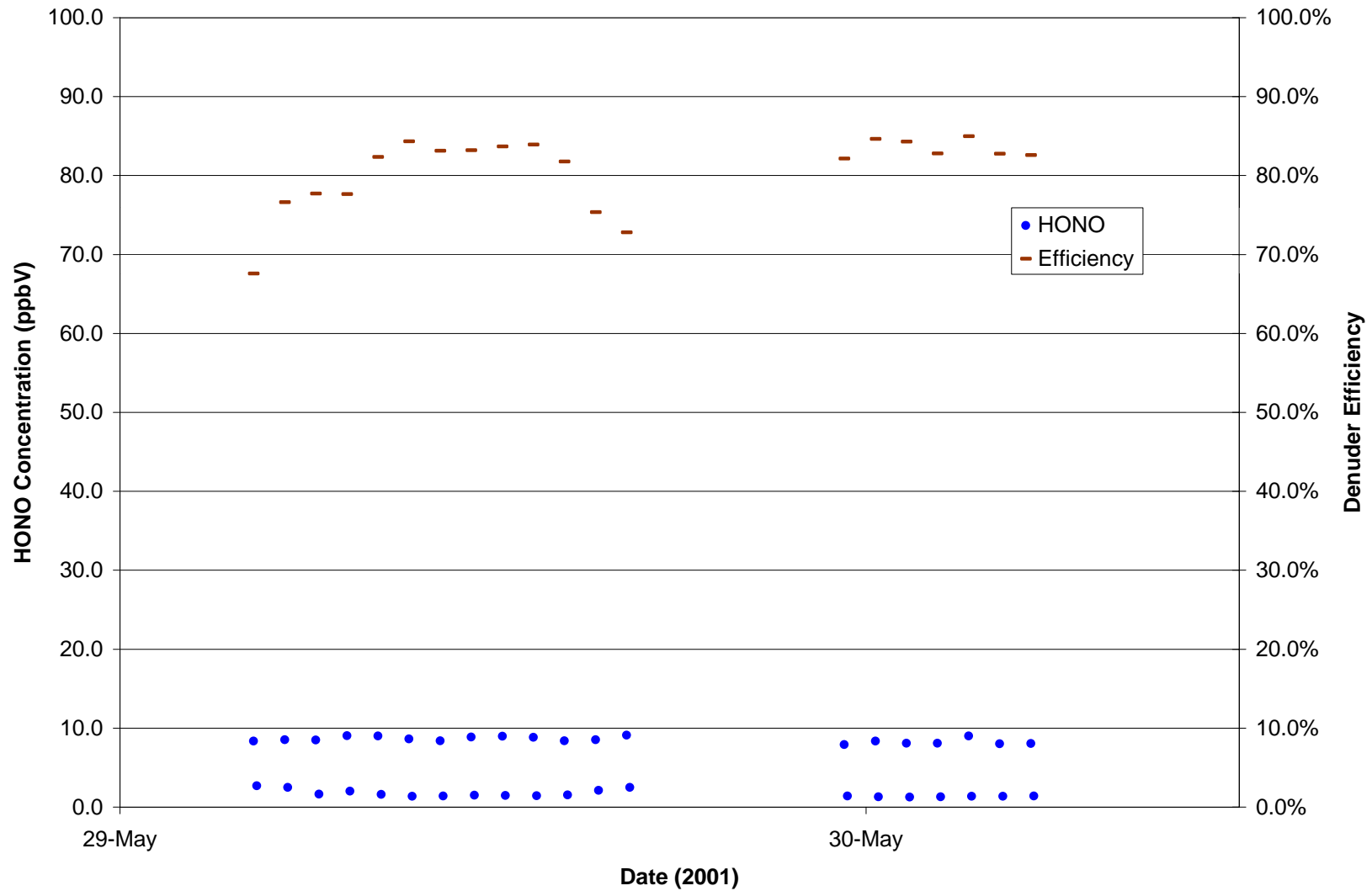

EPA Denuder Efficiency Evaluation Denuder 5
Experiment 16 (Low Humidity, Low HONO Concentration)

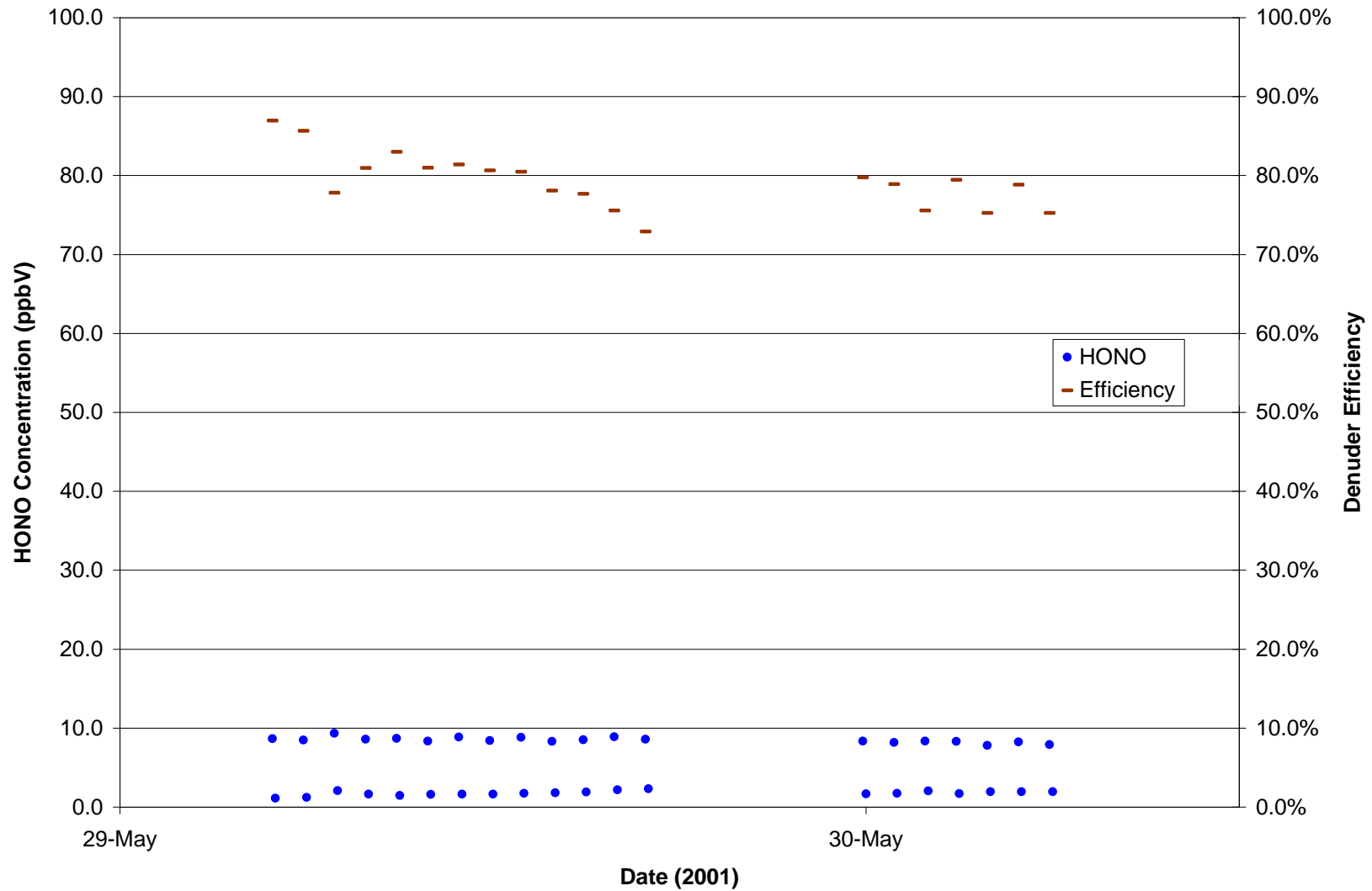

EPA Denuder Efficiency Evaluation Denuder 1 Experiment 17 (Low Humidity, Low HONO Concentration)

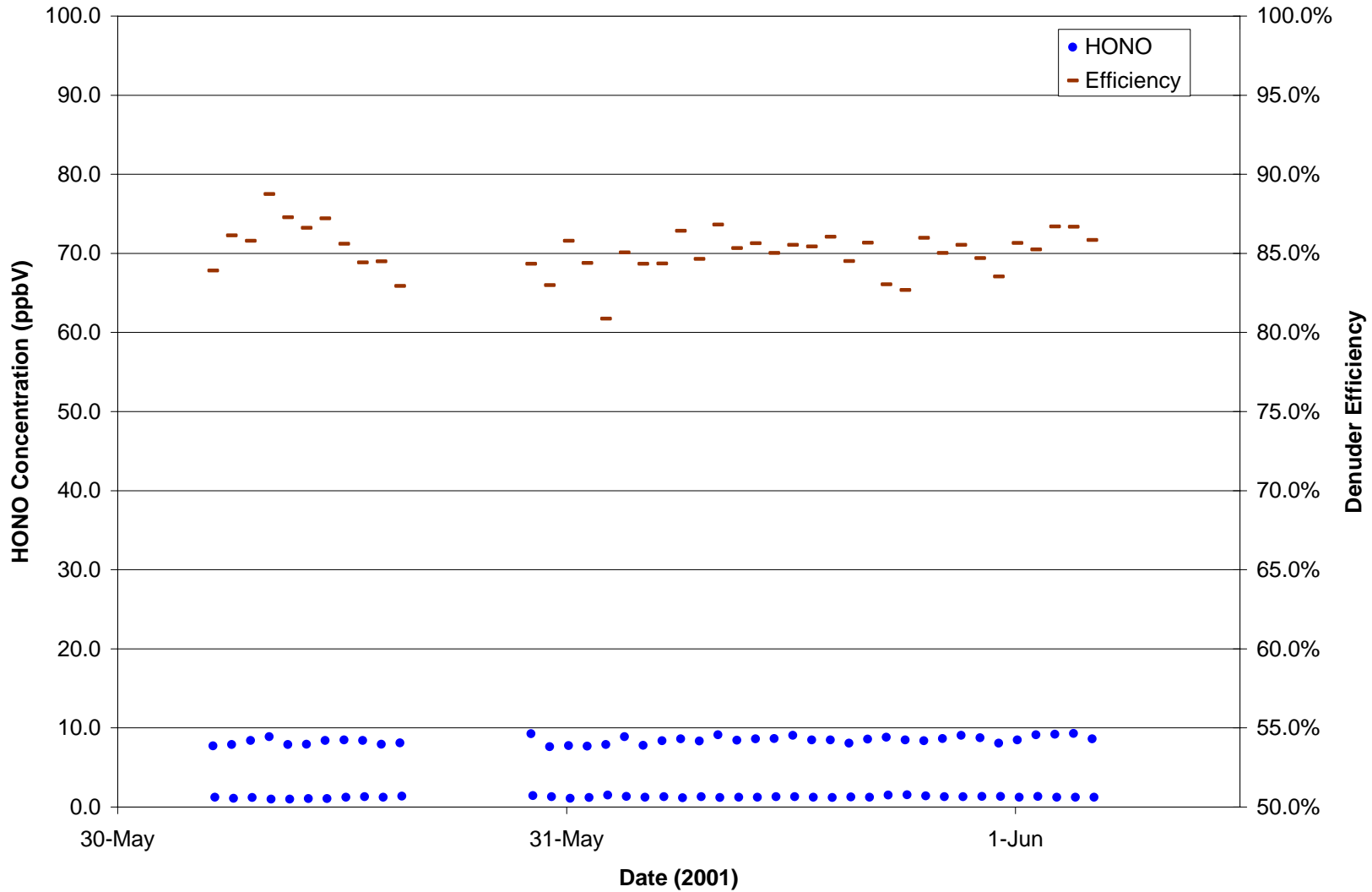

EPA Denuder Efficiency Evaluation Denuder 4 Experiment 17 (Low Humidity, Low HONO Concentration)

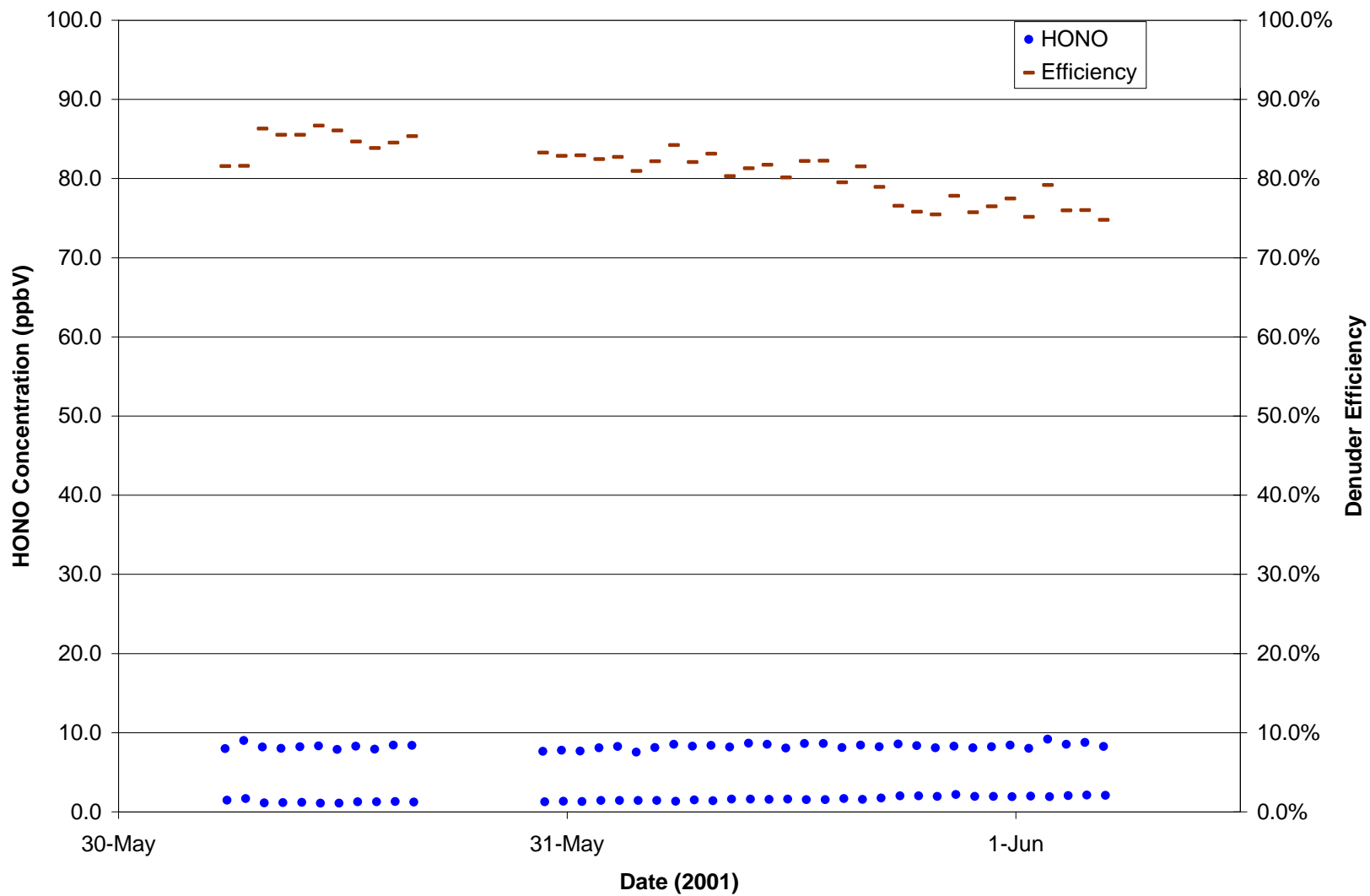

EPA Denuder Efficiency Evaluation Denuder 2 Experiment 17 (Low Humidity, Low HONO Concentration)

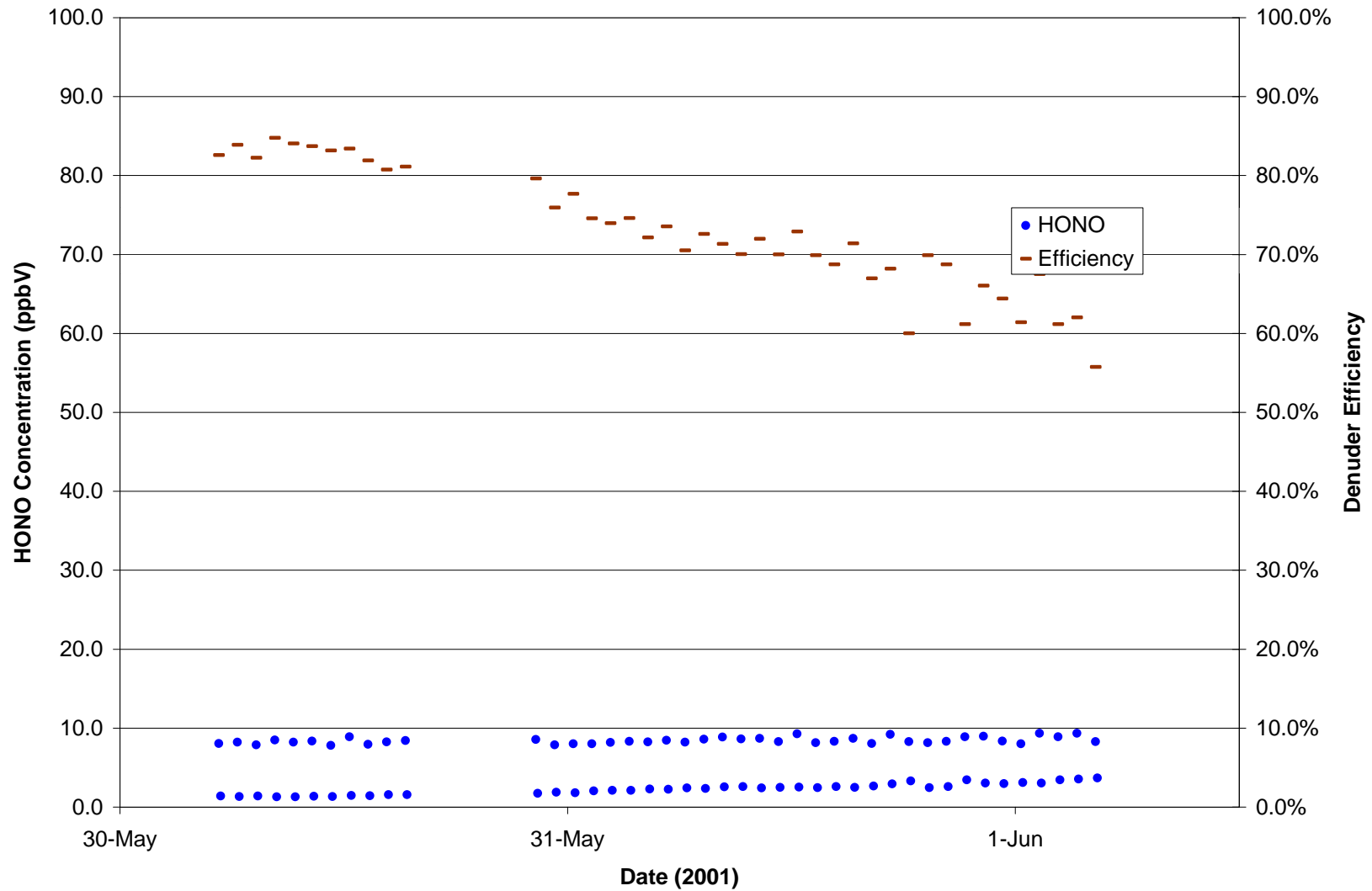

EPA Denuder Efficiency Evaluation Denuder 1 Experiment 18 (Low Humidity, Low PAN Concentration)

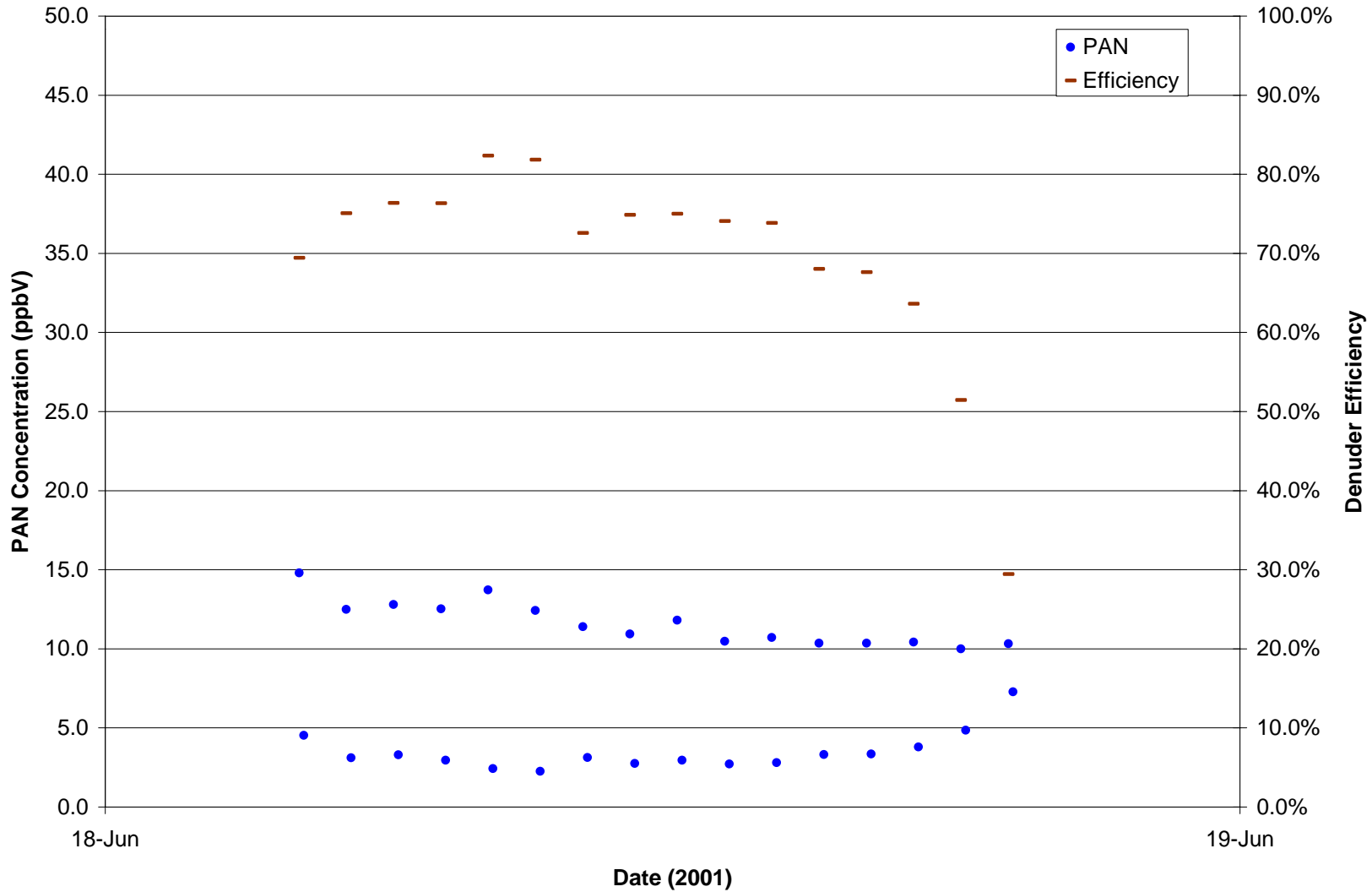

EPA Denuder Efficiency Evaluation Denuder 4 Experiment 18 (Low Humidity, Low PAN Concentration)

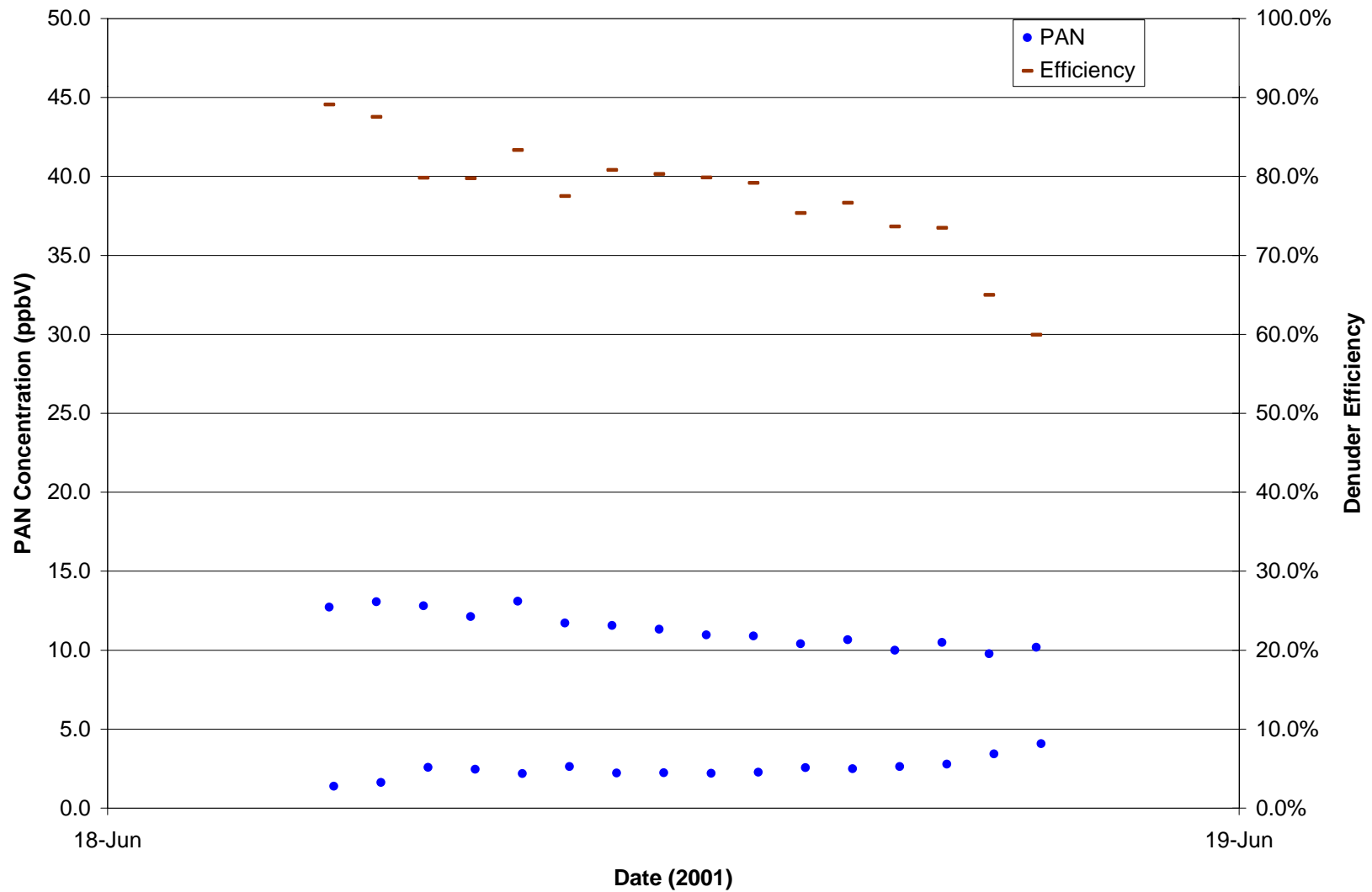

EPA Denuder Efficiency Evaluation Denuder 3
Experiment 18 (Low Humidity, Low PAN Concentration)

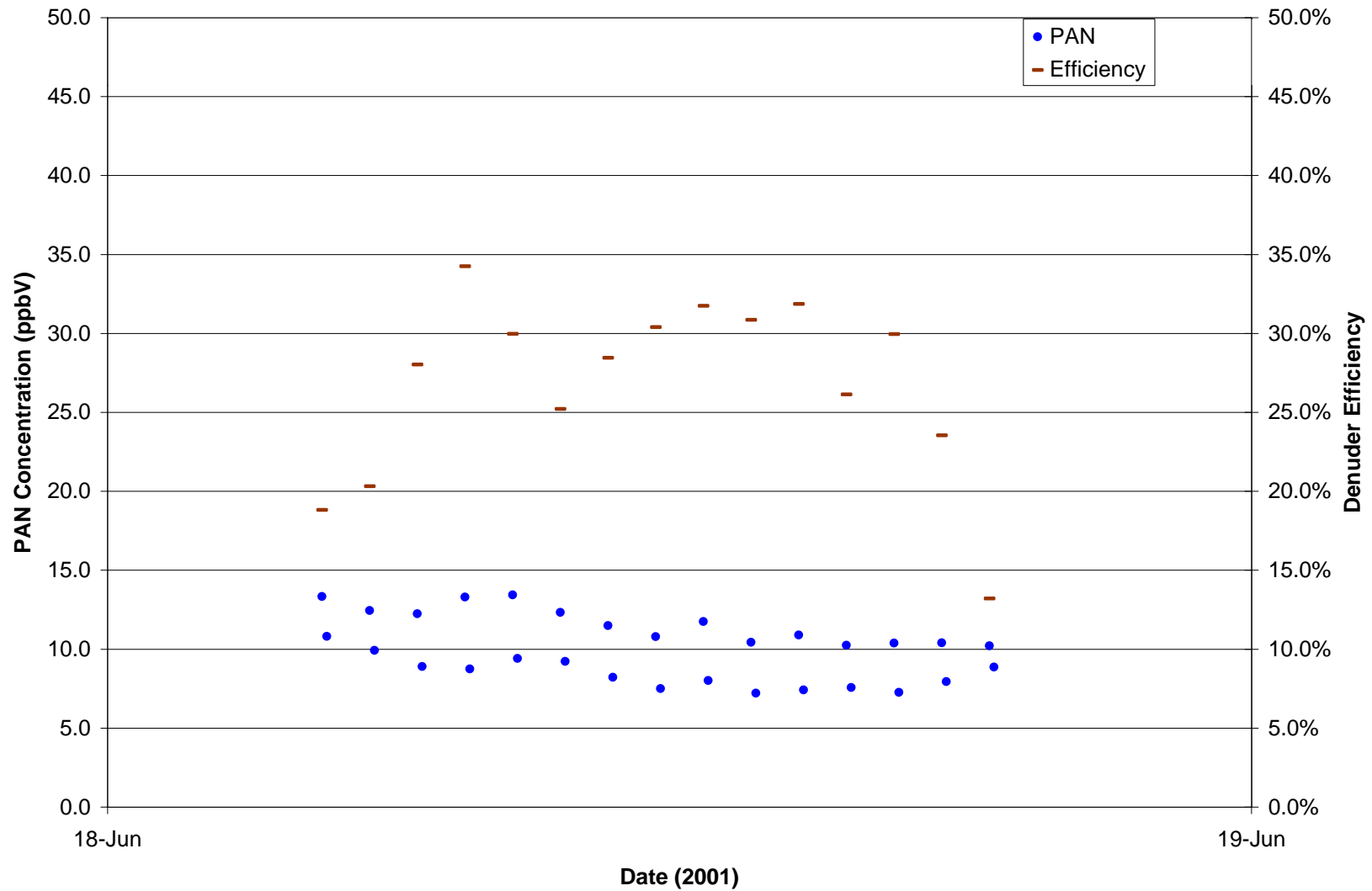

EPA Denuder Efficiency Evaluation Denuder 2
Experiment 18 (Low Humidity, Low PAN Concentration)

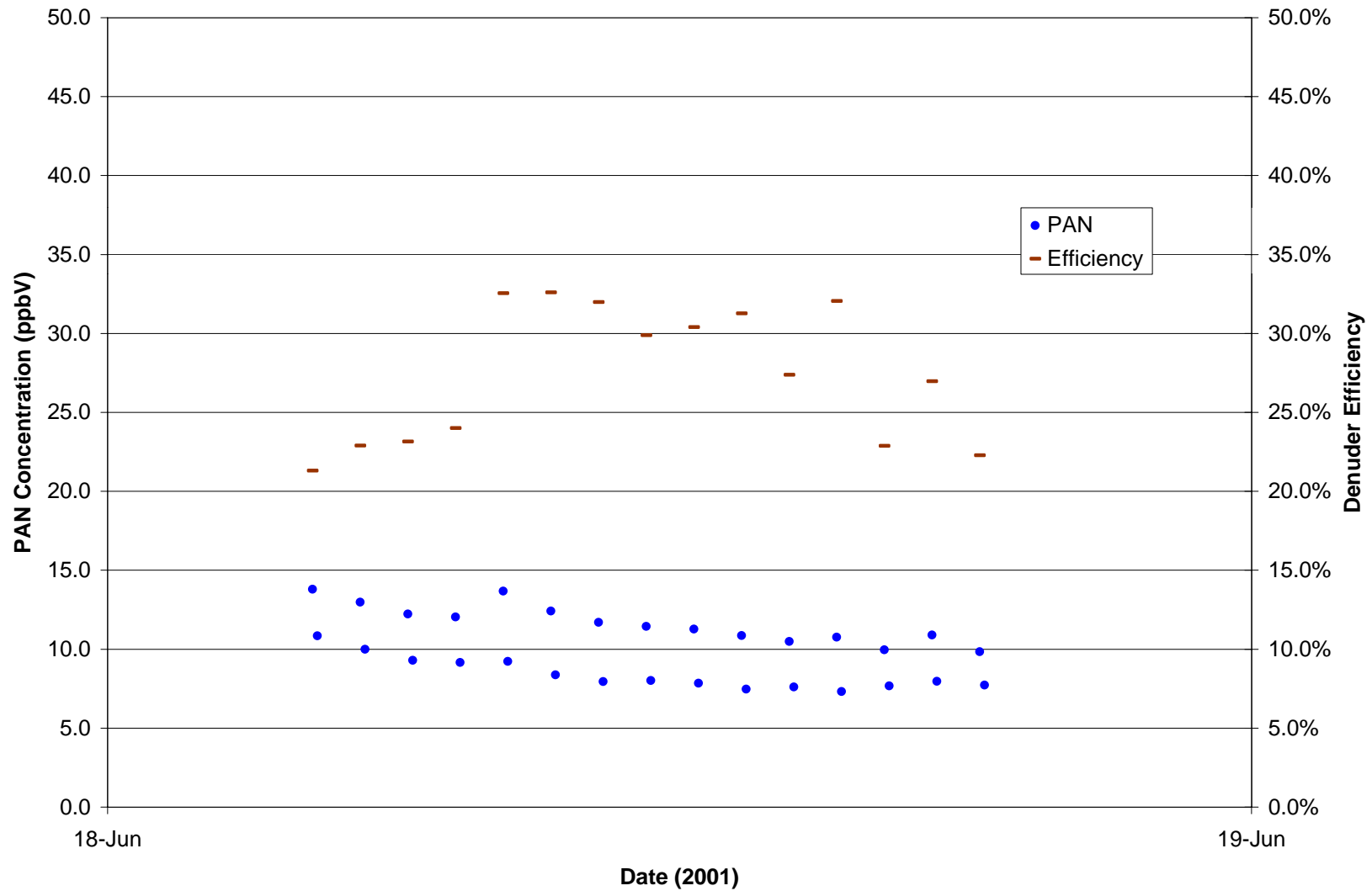

EPA Denuder Efficiency Evaluation Denuder 5
Experiment 18 (Low Humidity, Low PAN Concentration)

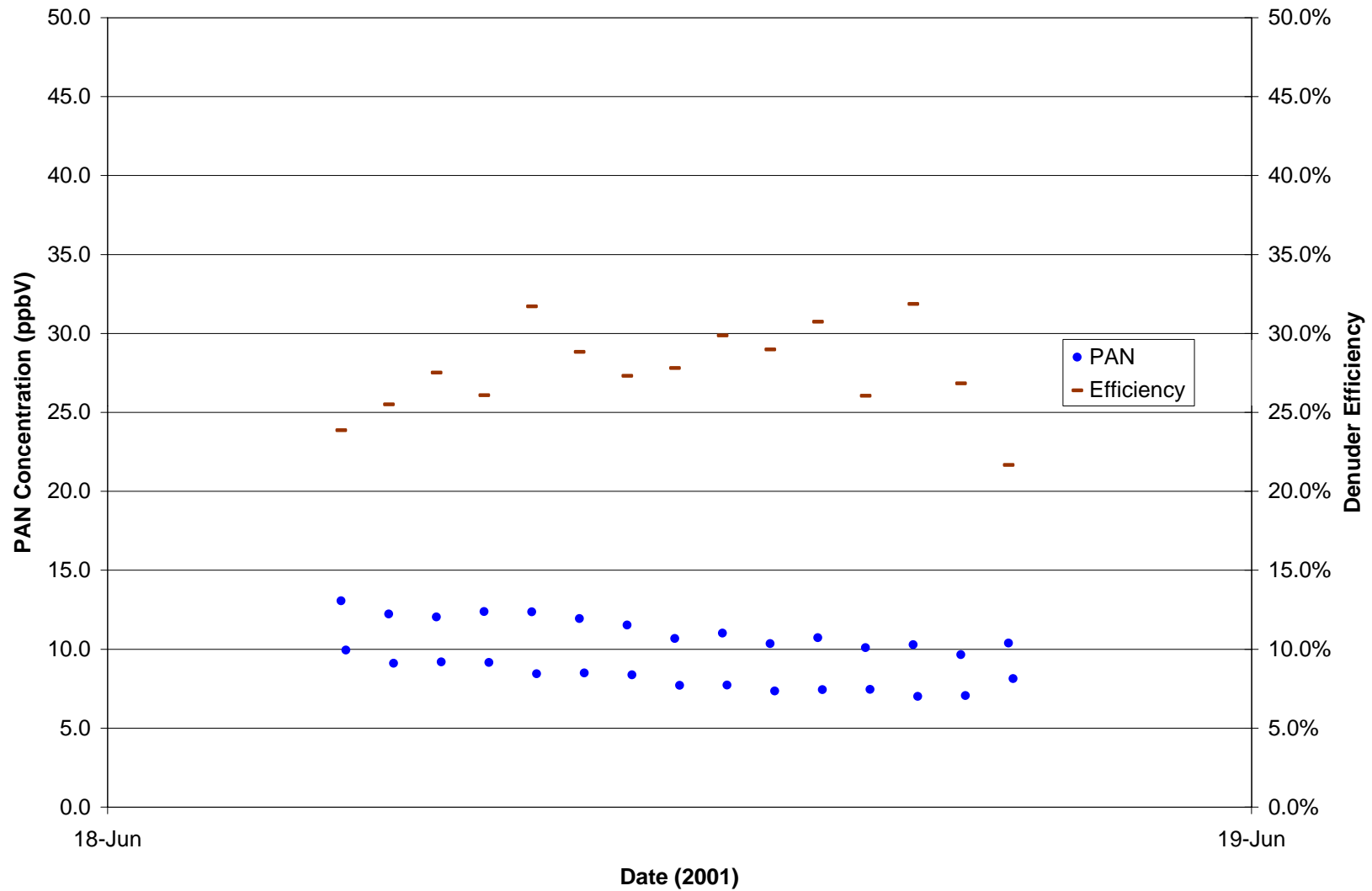

EPA Denuder Efficiency Evaluation Denuder 1 Experiment 19 (High Humidity, Low PAN Concentration)

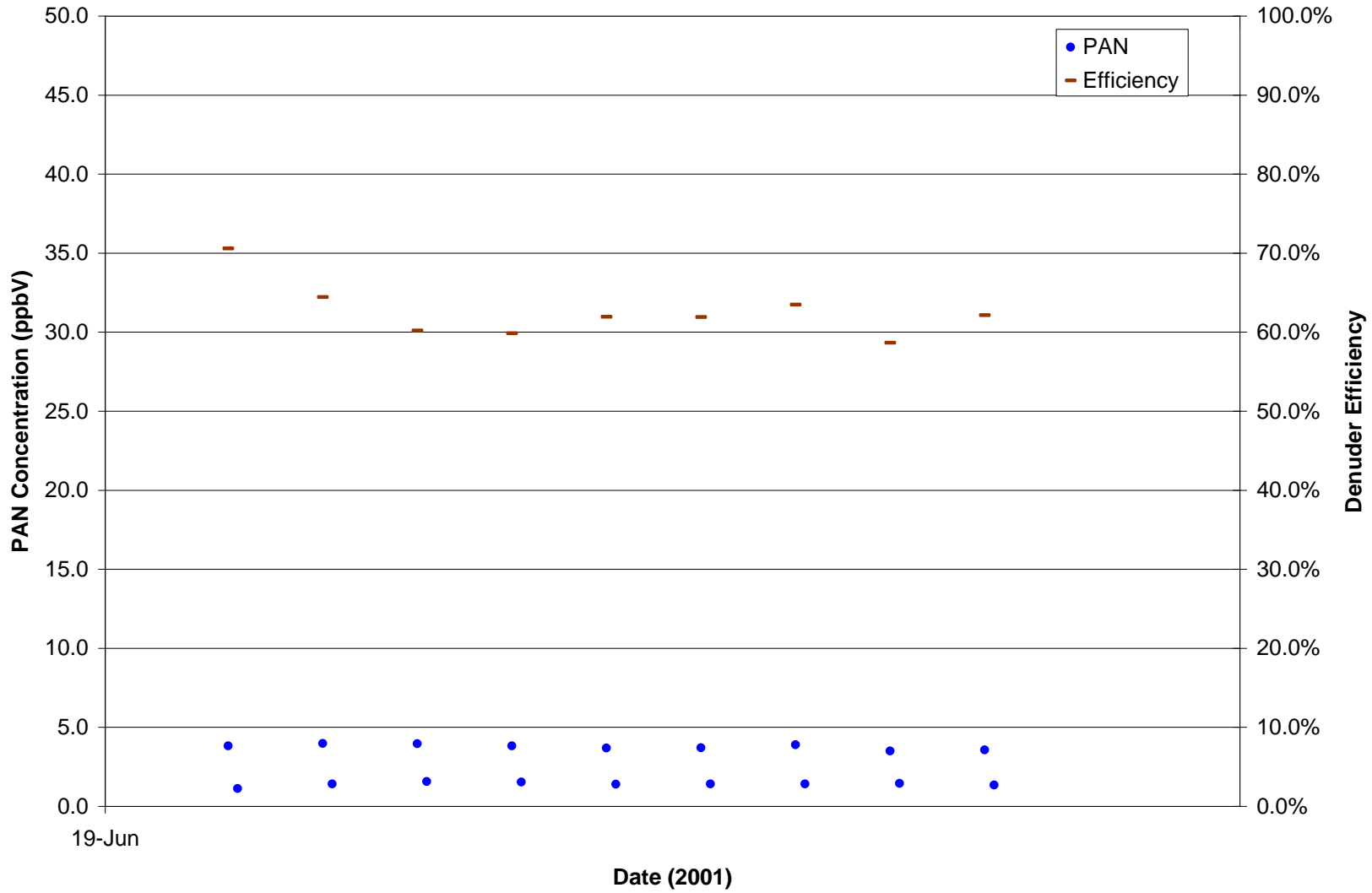

EPA Denuder Efficiency Evaluation Denuder 4 Experiment 19 (High Humidity, Low PAN Concentration)

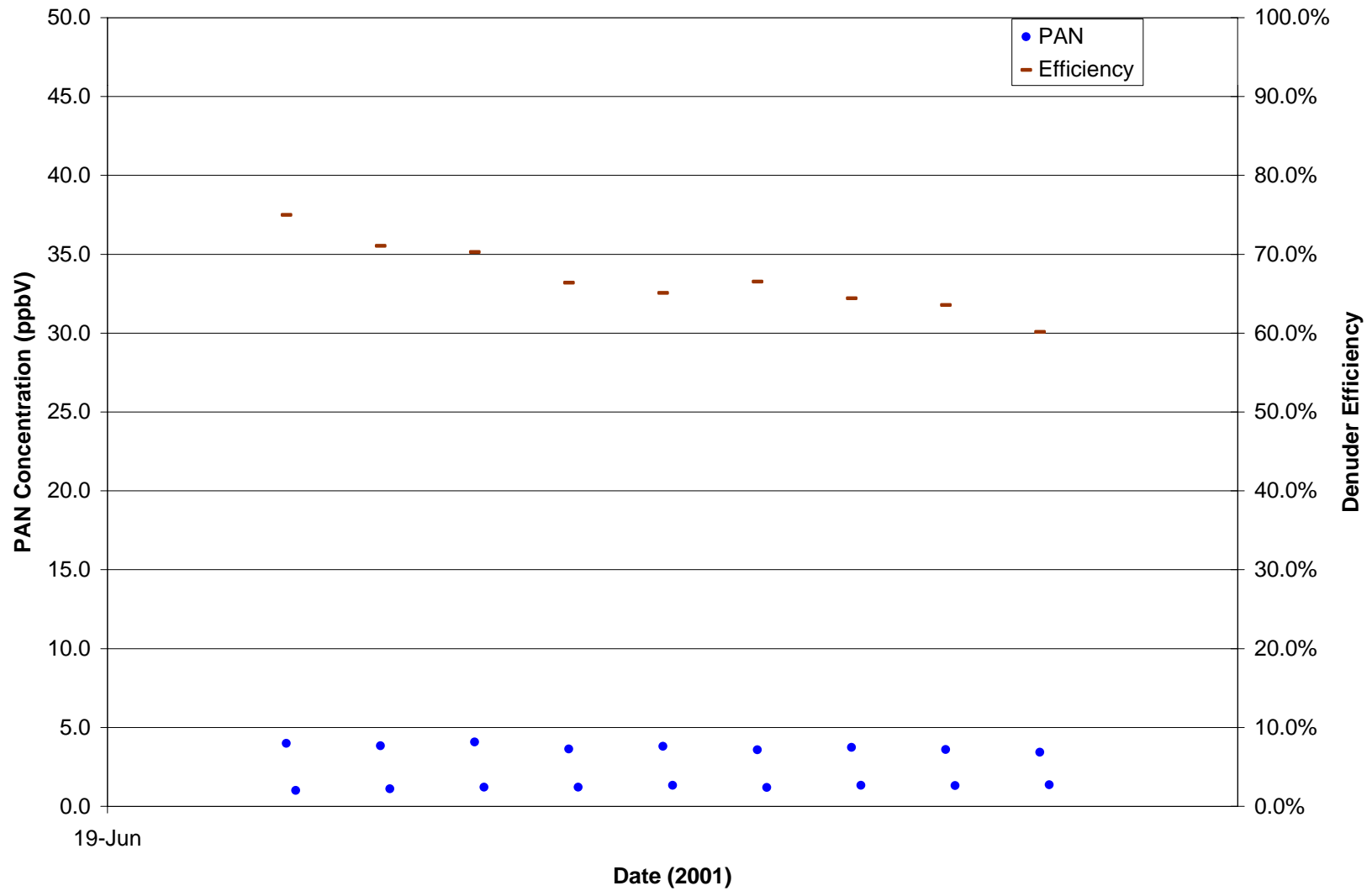

EPA Denuder Efficiency Evaluation Denuder 3 Experiment 19 (High Humidity, Low PAN Concentration)

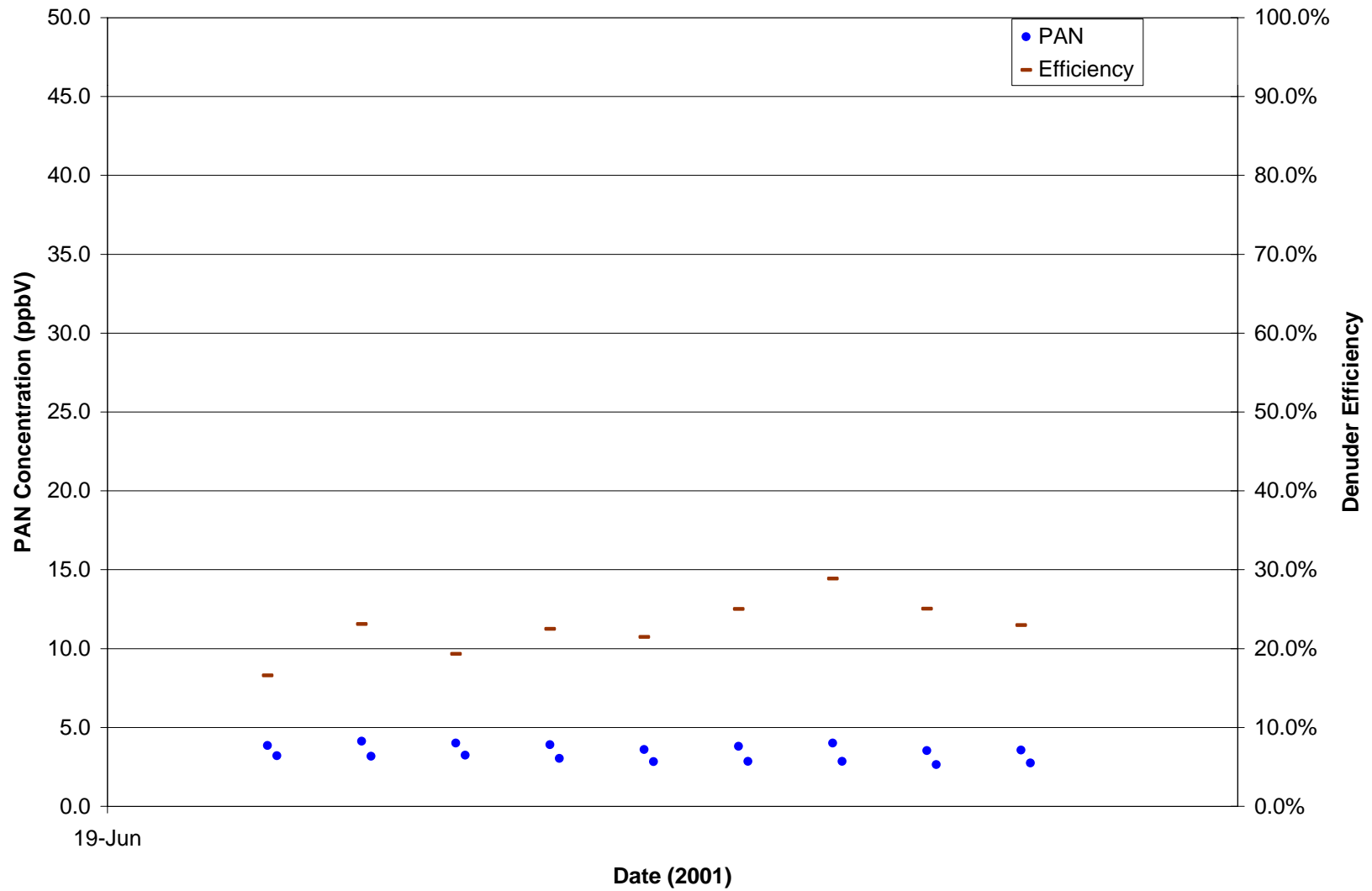

EPA Denuder Efficiency Evaluation Denuder 2
Experiment 19 (High Humidity, Low PAN Concentration)

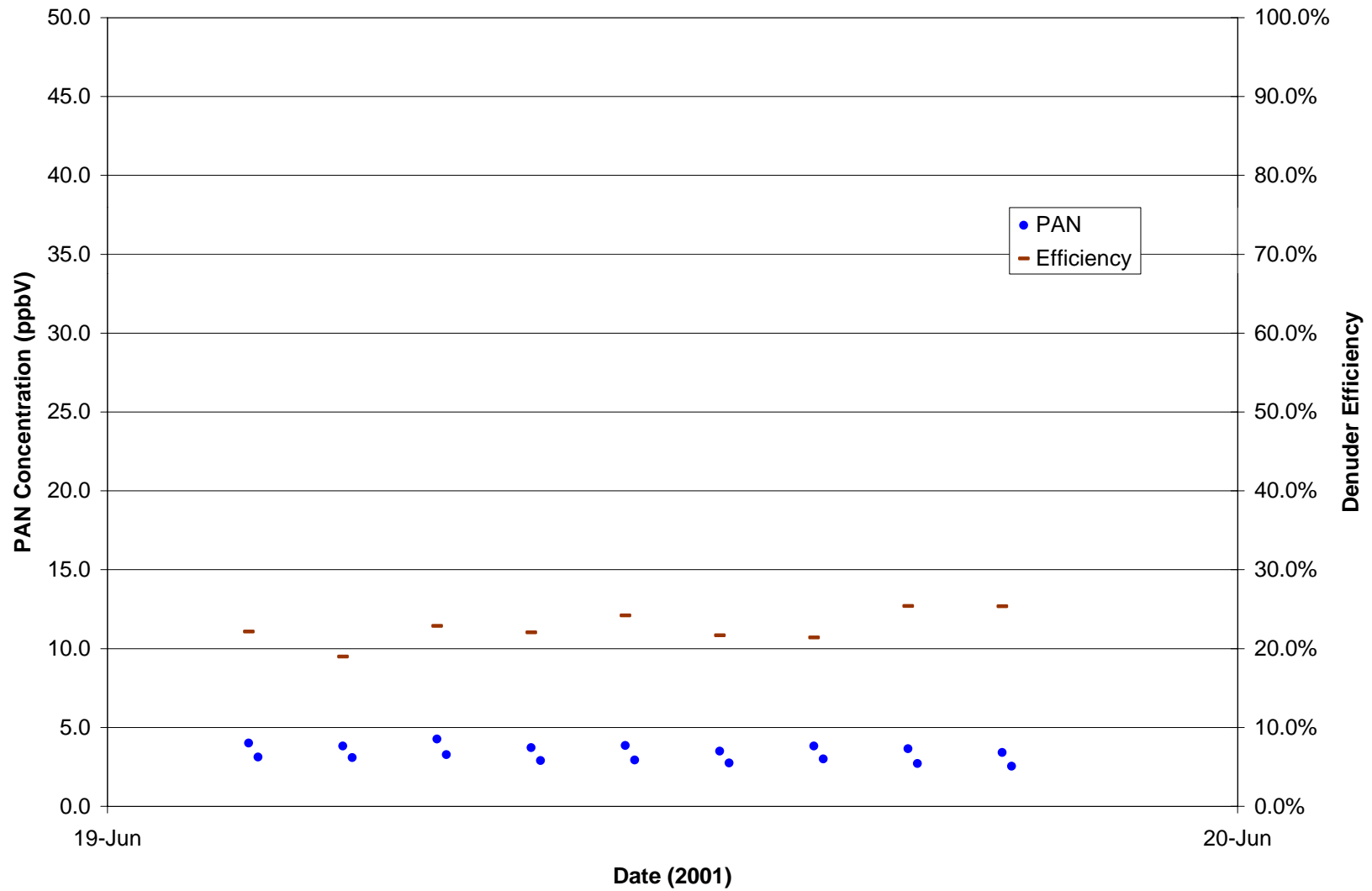

EPA Denuder Efficiency Evaluation Denuder 5
Experiment 19 (High Humidity, Low PAN Concentration)

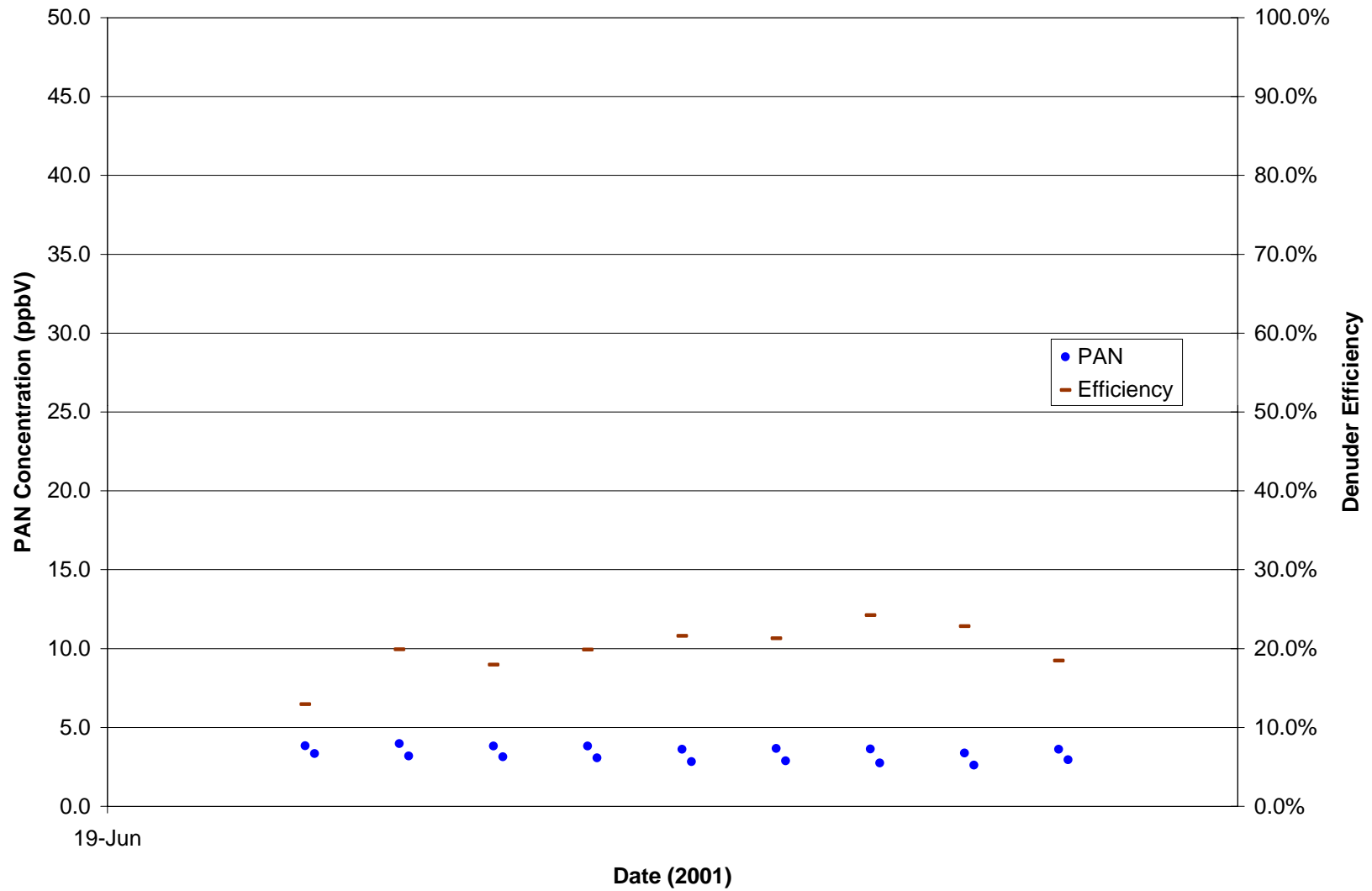

EPA Denuder Efficiency Evaluation Denuder 1 Experiment 20 (High Humidity, High PAN Concentration)

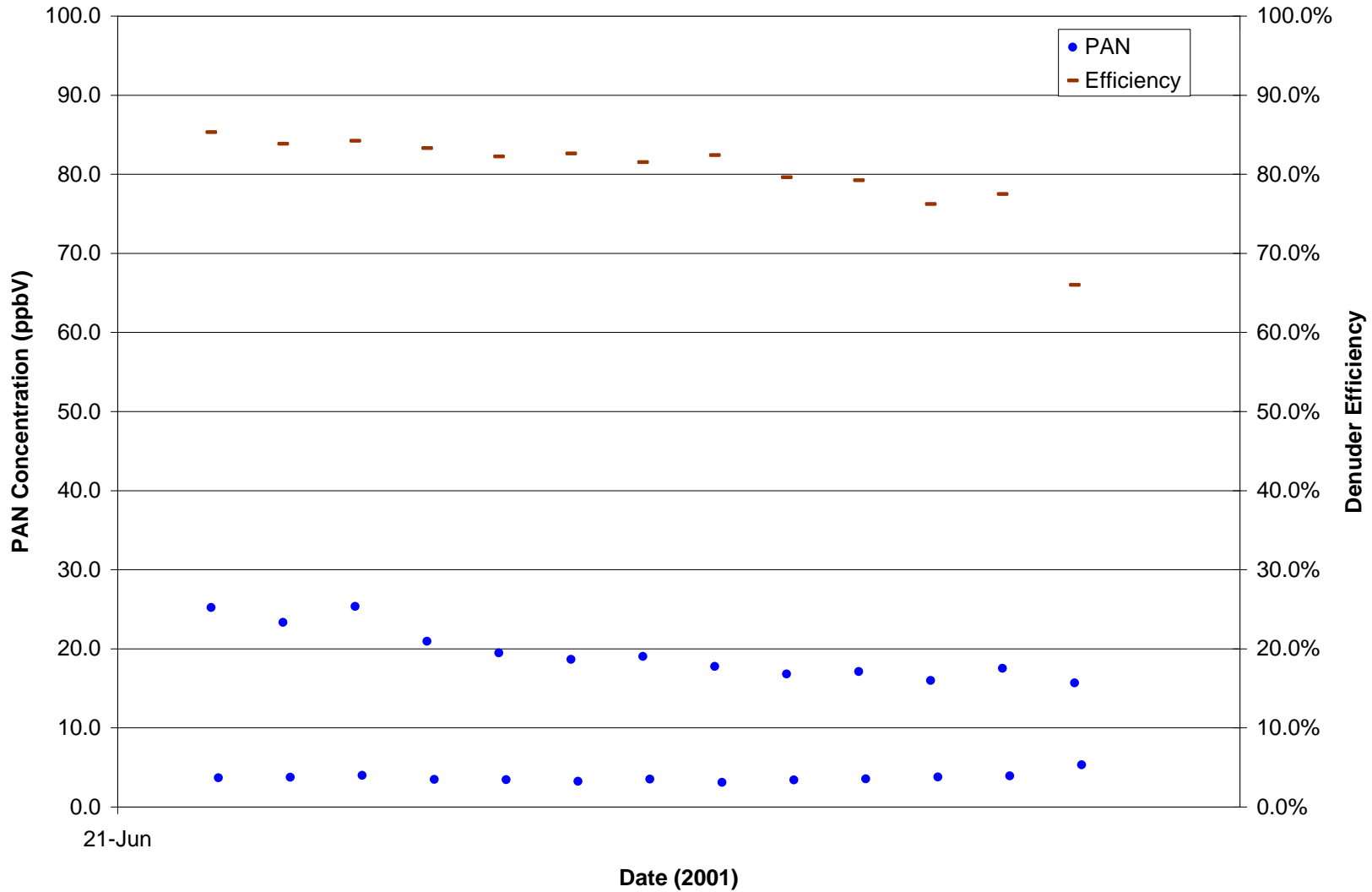

EPA Denuder Efficiency Evaluation Denuder 4 Experiment 20 (High Humidity, High PAN Concentration)

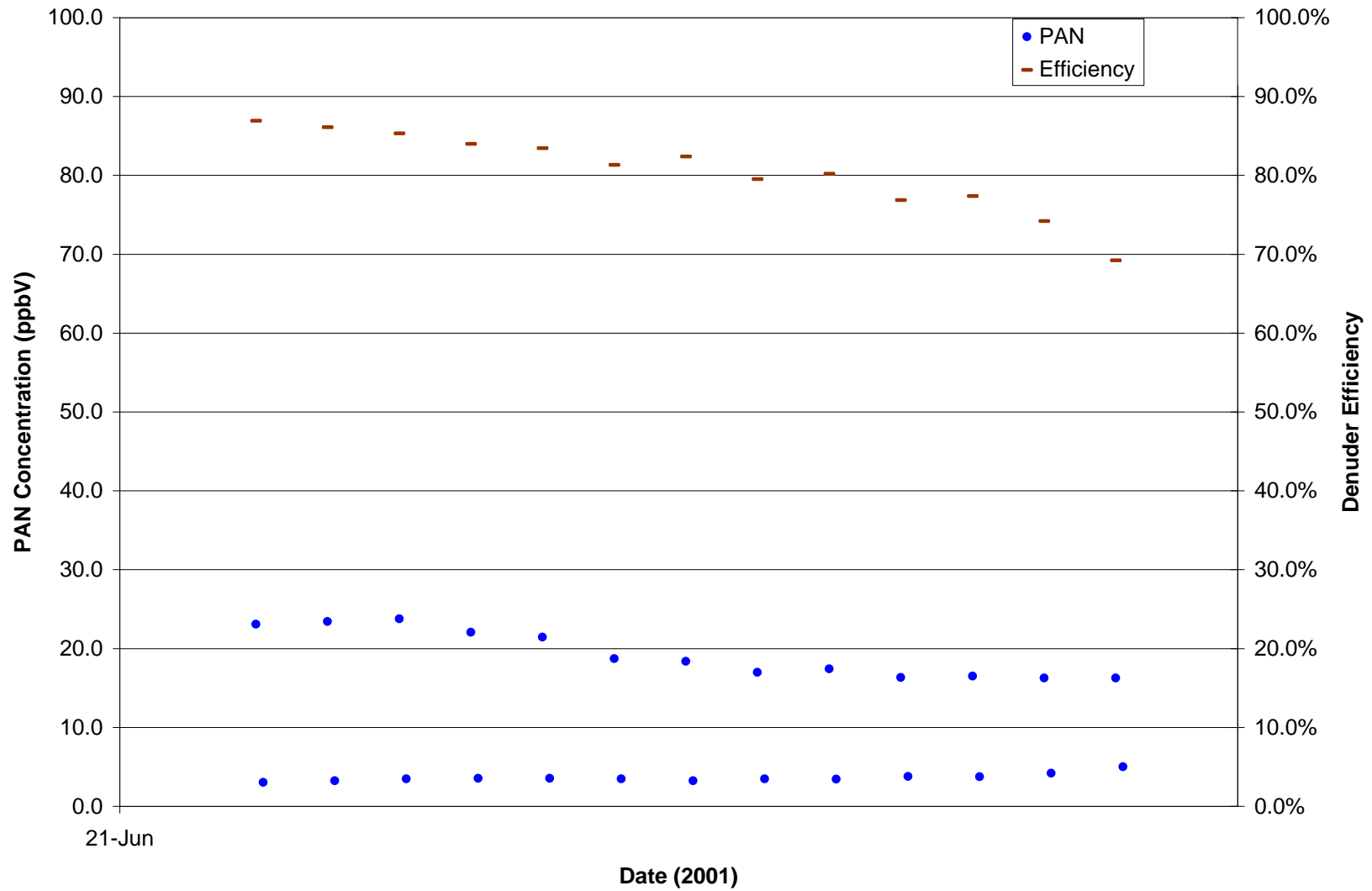

EPA Denuder Efficiency Evaluation Denuder 3 Experiment 20 (High Humidity, High PAN Concentration)

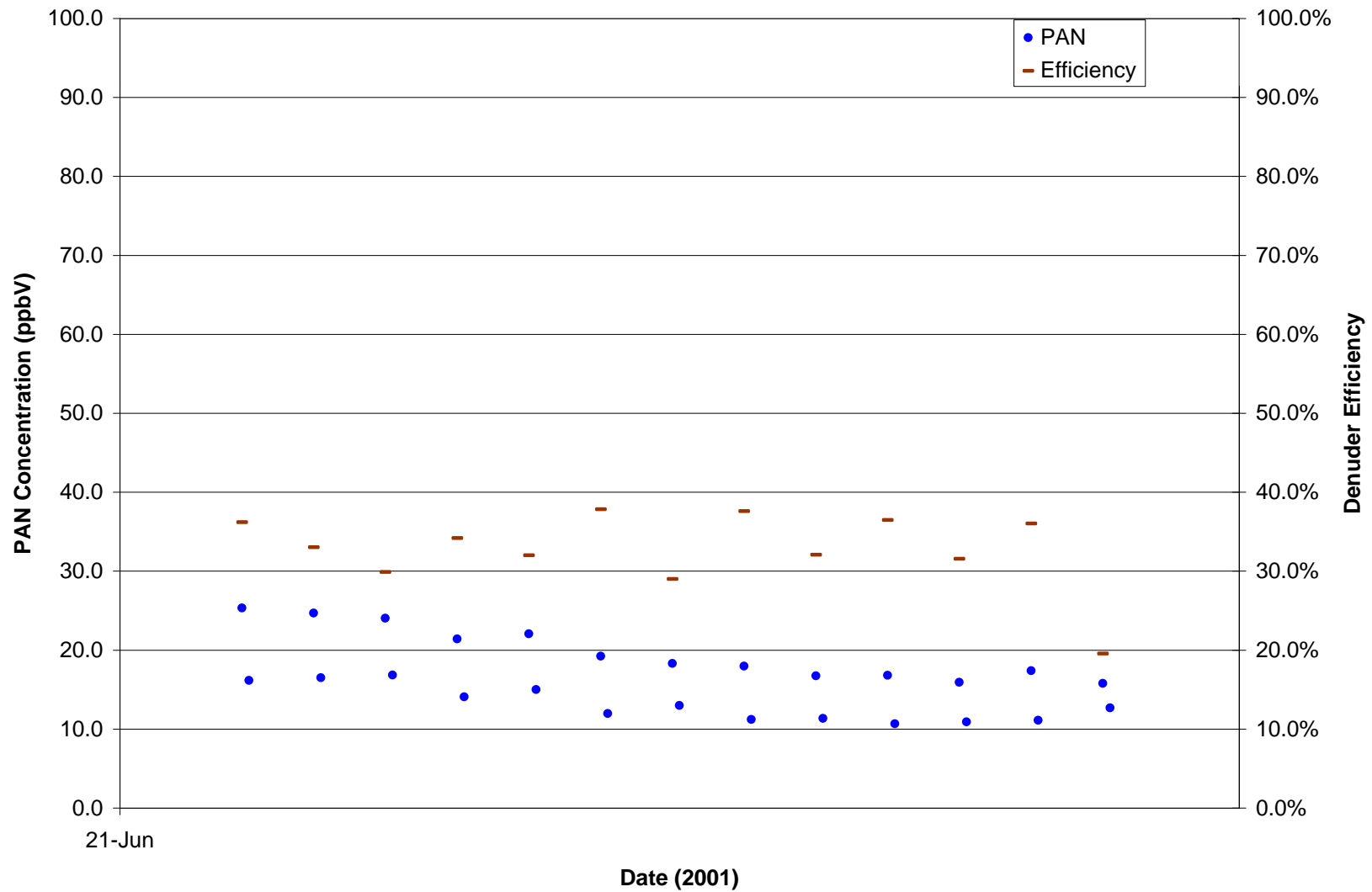

EPA Denuder Efficiency Evaluation Denuder 2
Experiment 20 (High Humidity, High PAN Concentration)

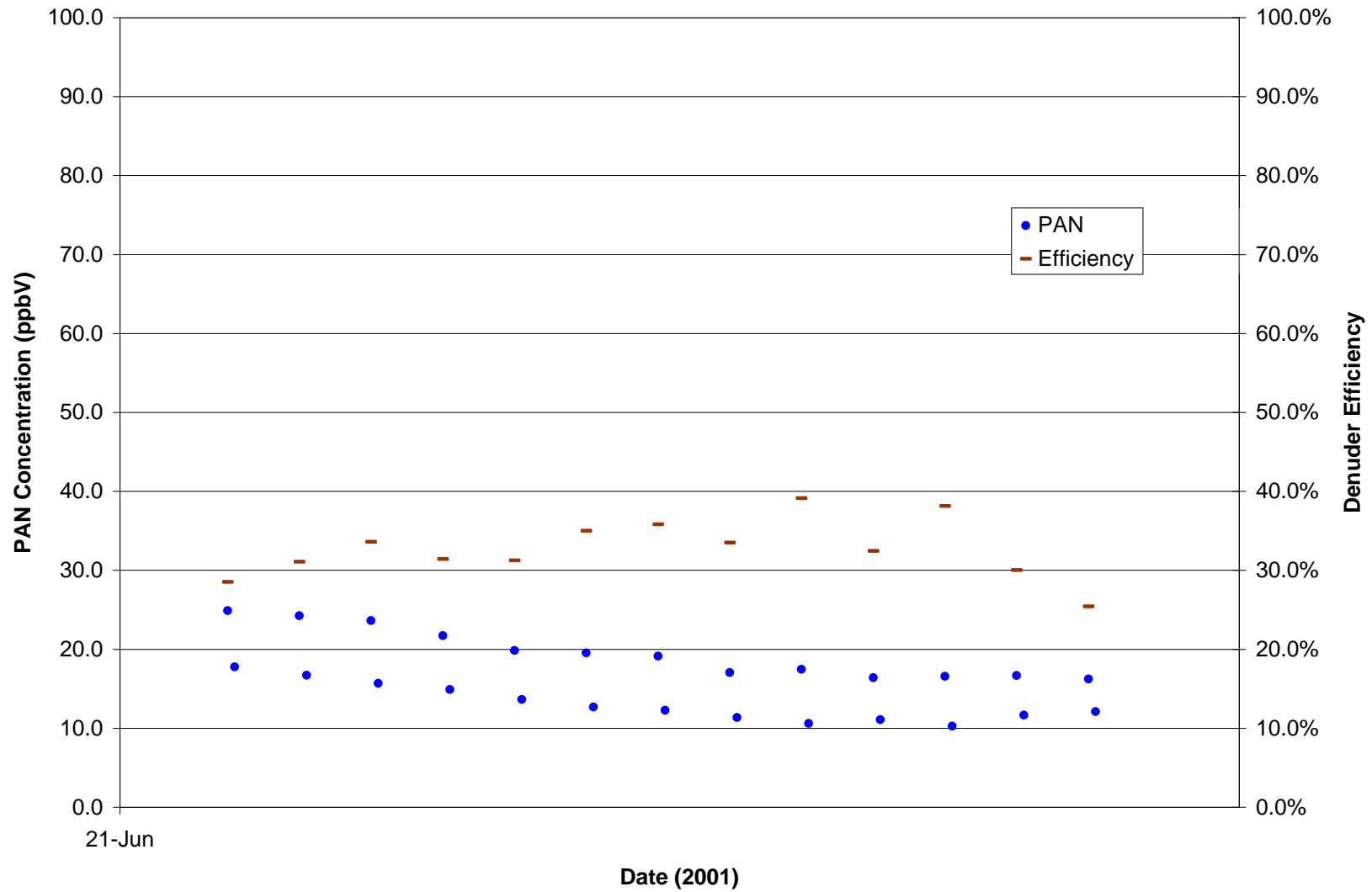

EPA Denuder Efficiency Evaluation Denuder 5 Experiment 20 (High Humidity, High PAN Concentration)

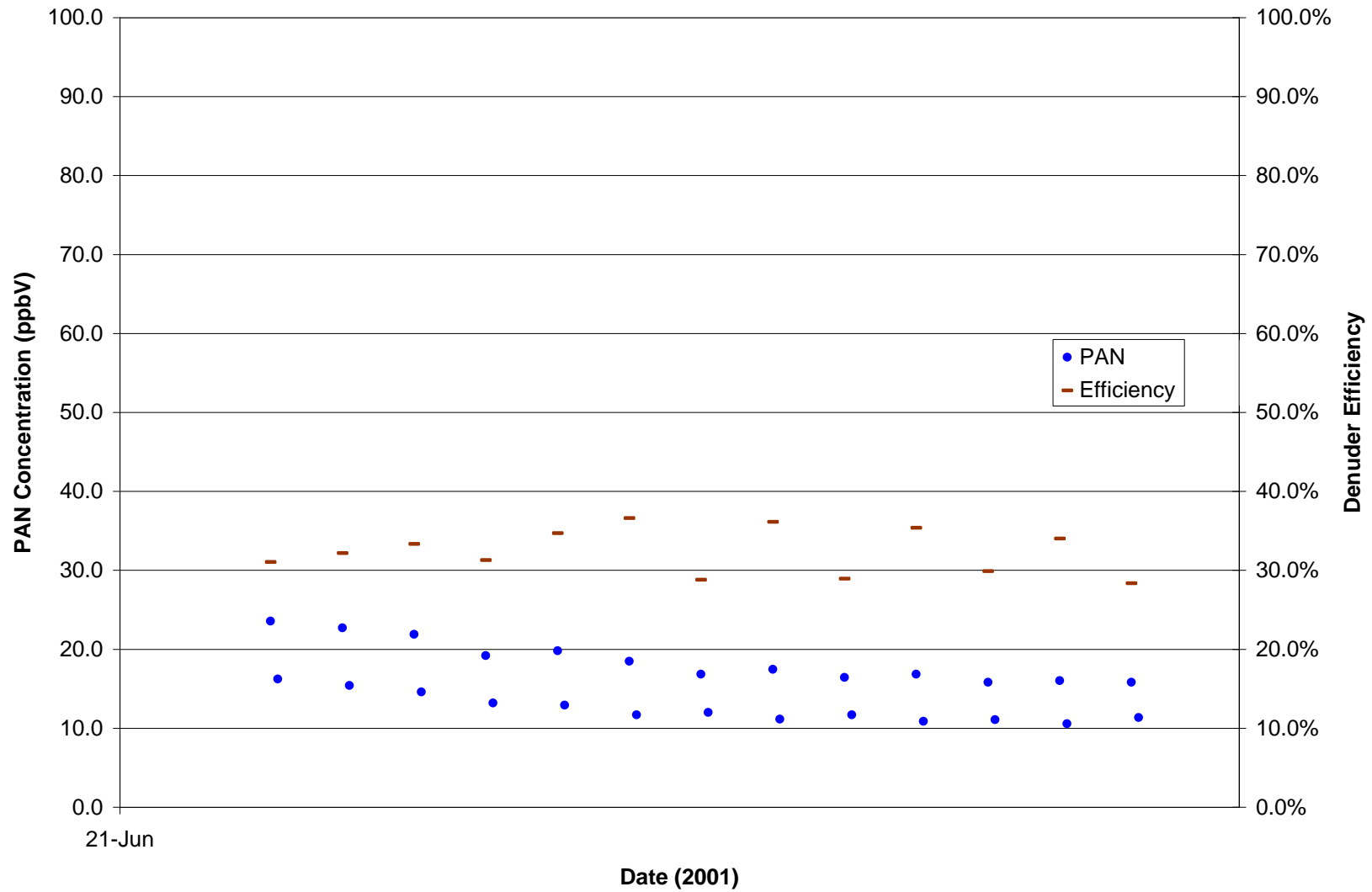

EPA Denuder Efficiency Evaluation Denuder 1 Experiment 21 (Low Humidity, High PAN Concentration)

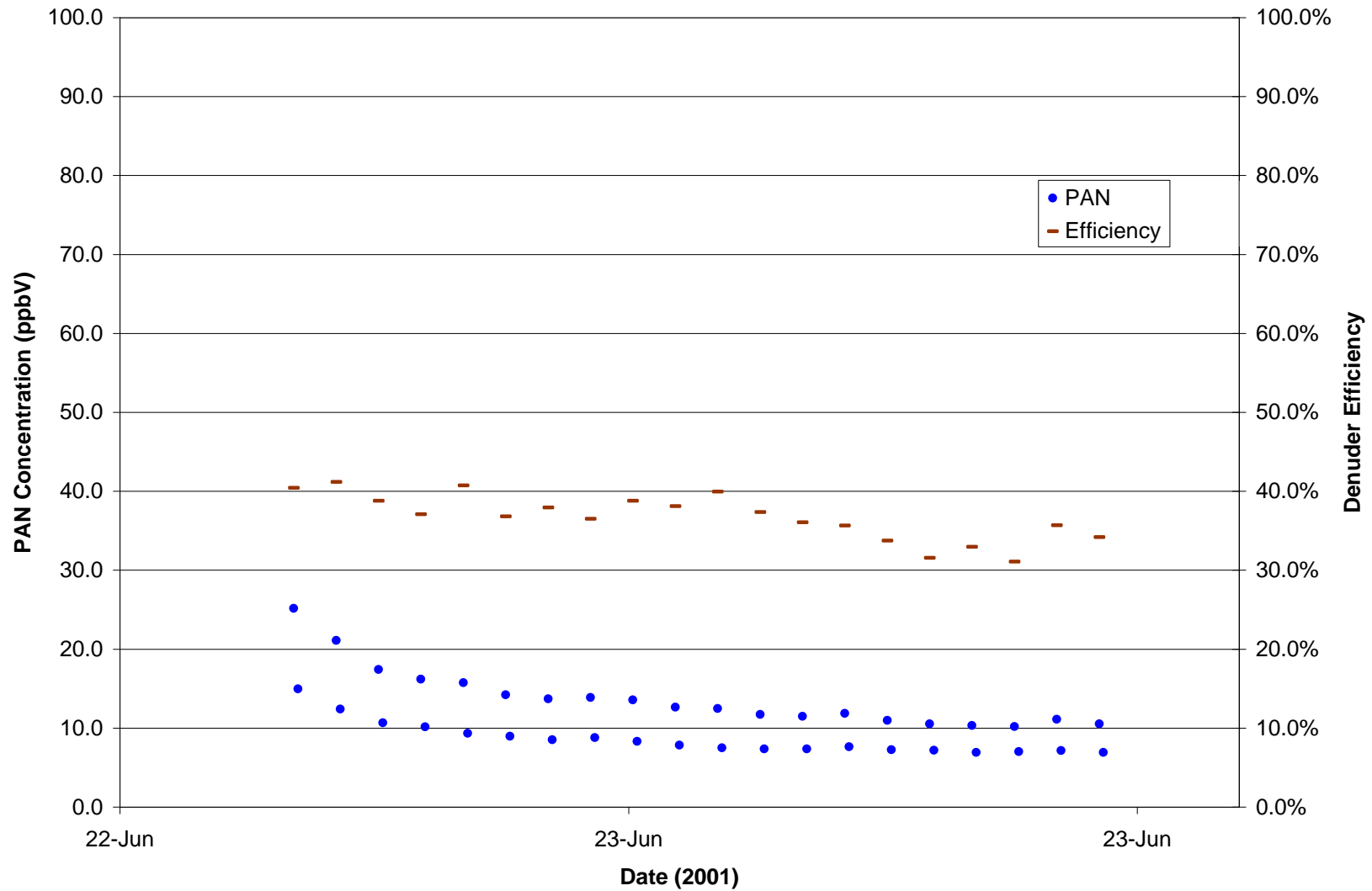

EPA Denuder Efficiency Evaluation Denuder 3 Experiment 21 (Low Humidity, High PAN Concentration)

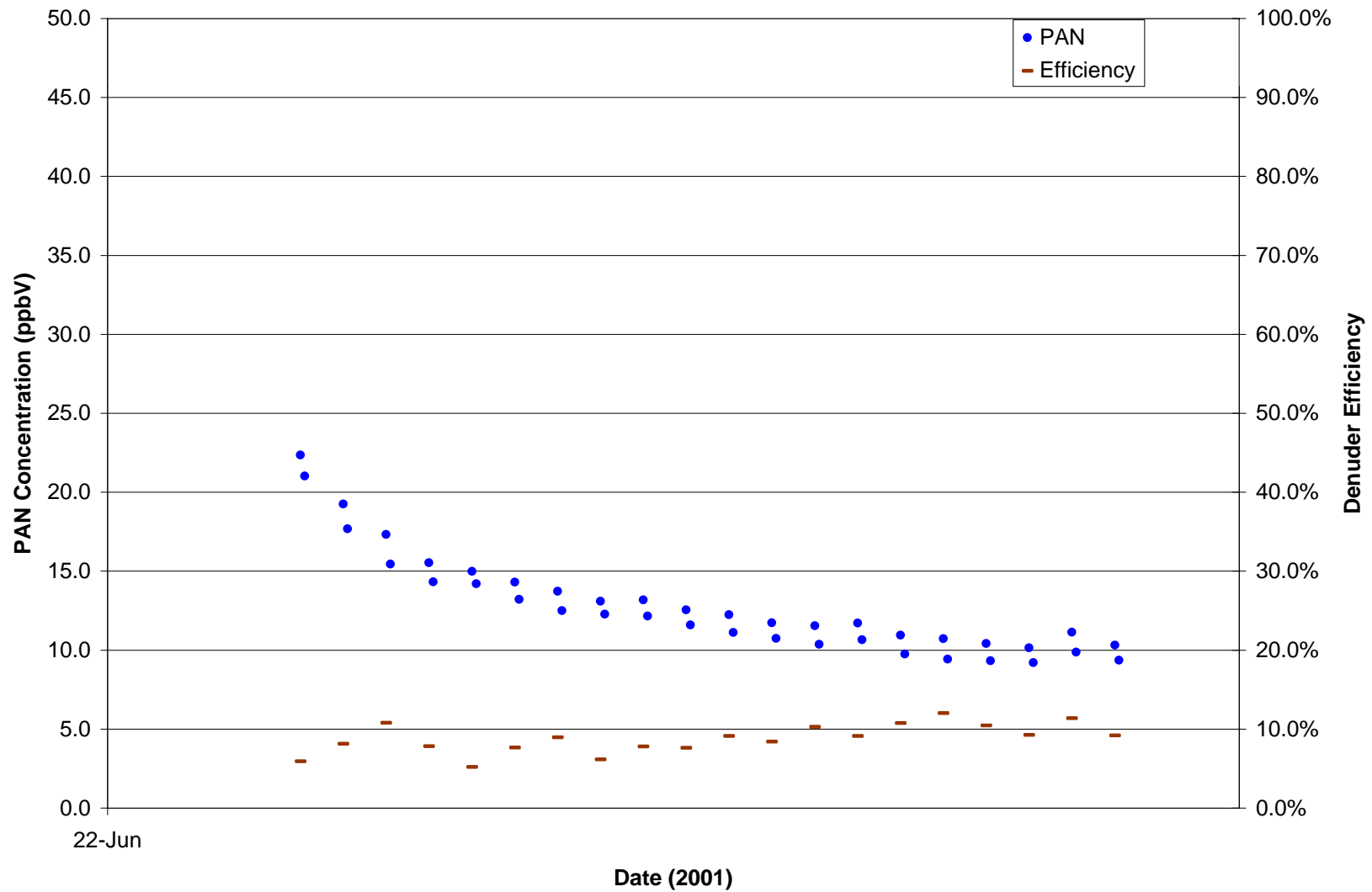

EPA Denuder Efficiency Evaluation Denuder 5 Experiment 21 (Low Humidity, Low PAN Concentration)

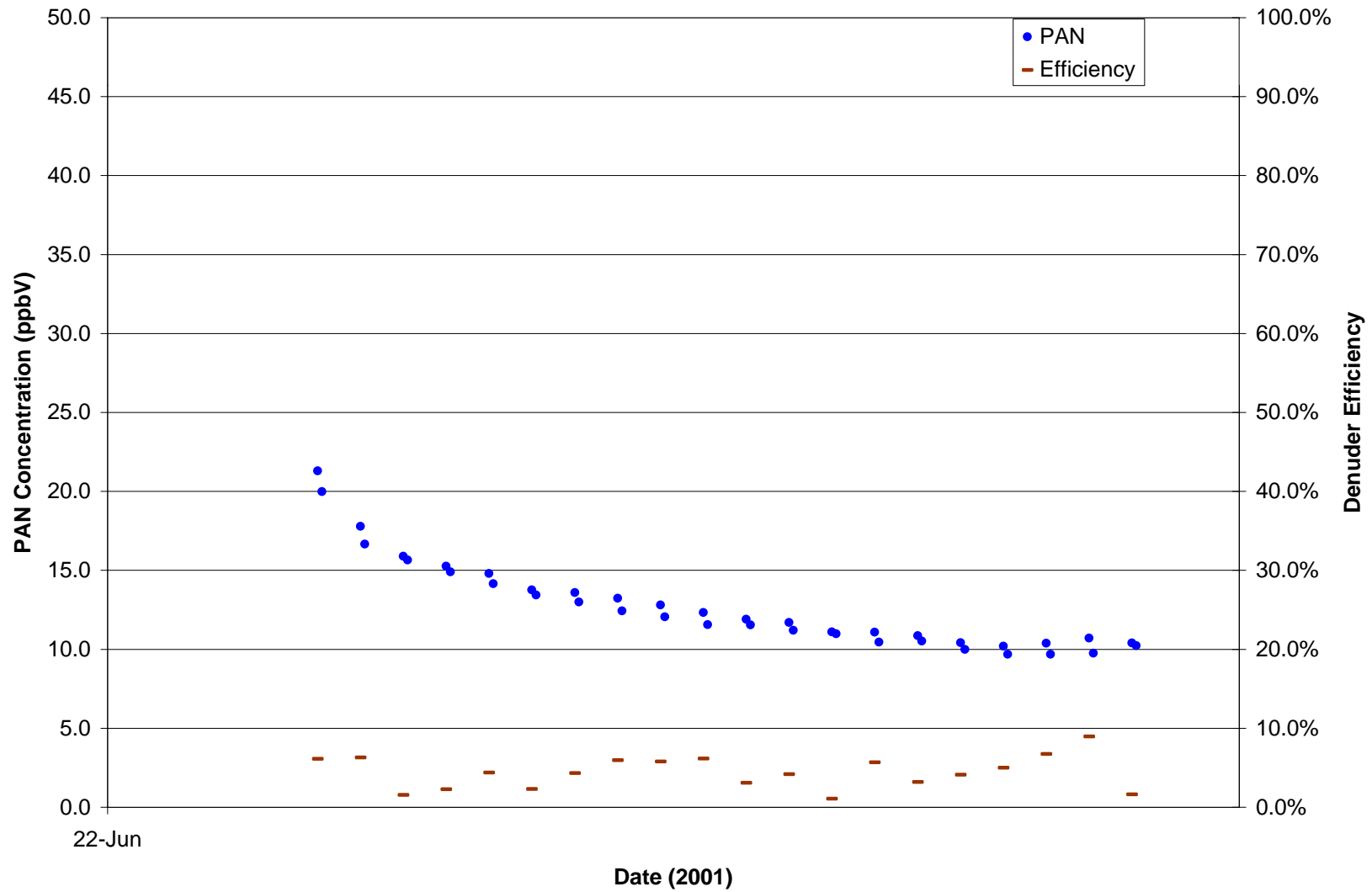

EPA Denuder Efficiency Evaluation Filter Section
Experiment 22: Low Humidity NO₂ Test for Filter 1

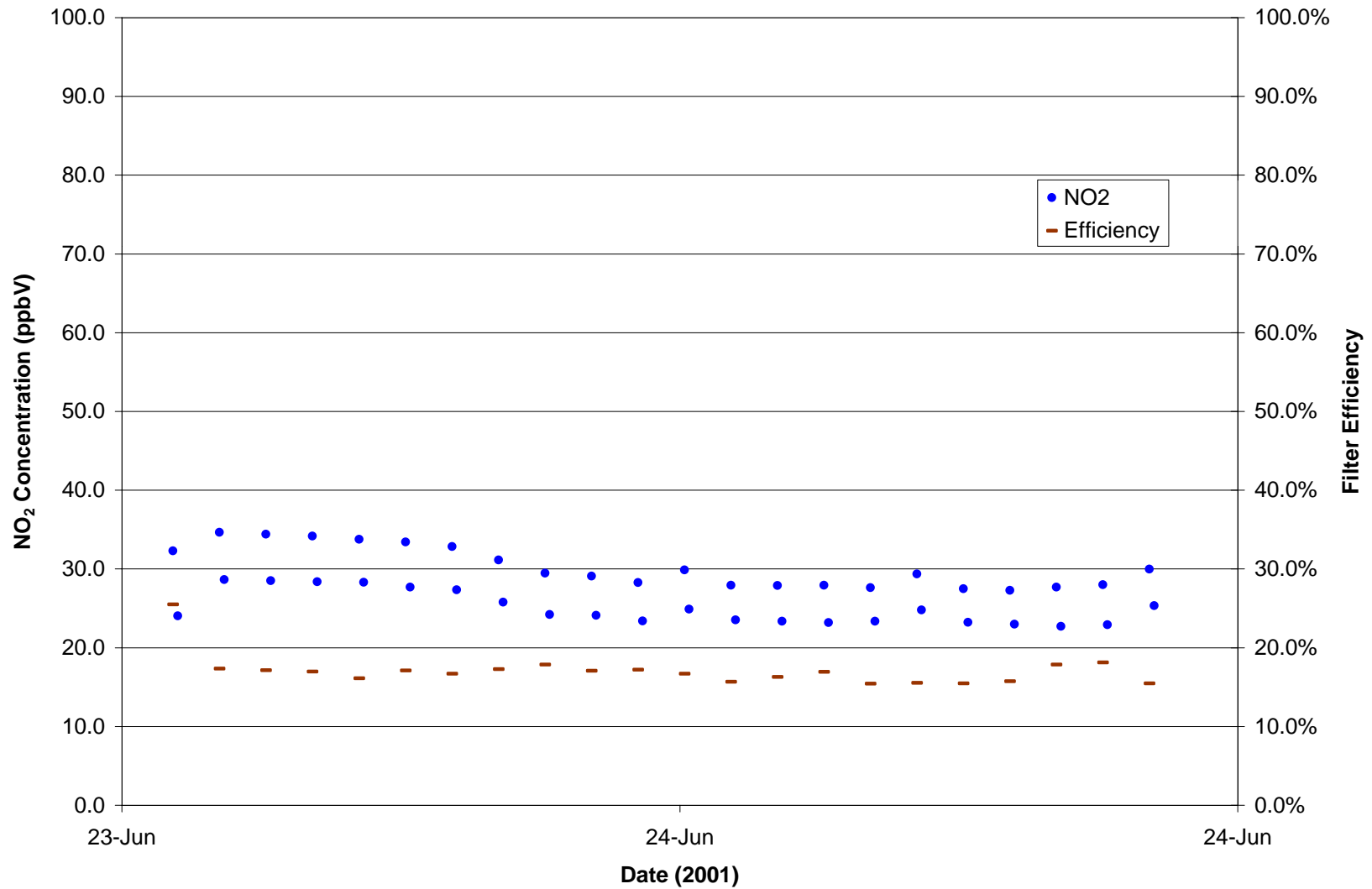

EPA Denuder Efficiency Evaluation Filter Section
Experiment 22: Low Humidity NO2 Test for Filter 4

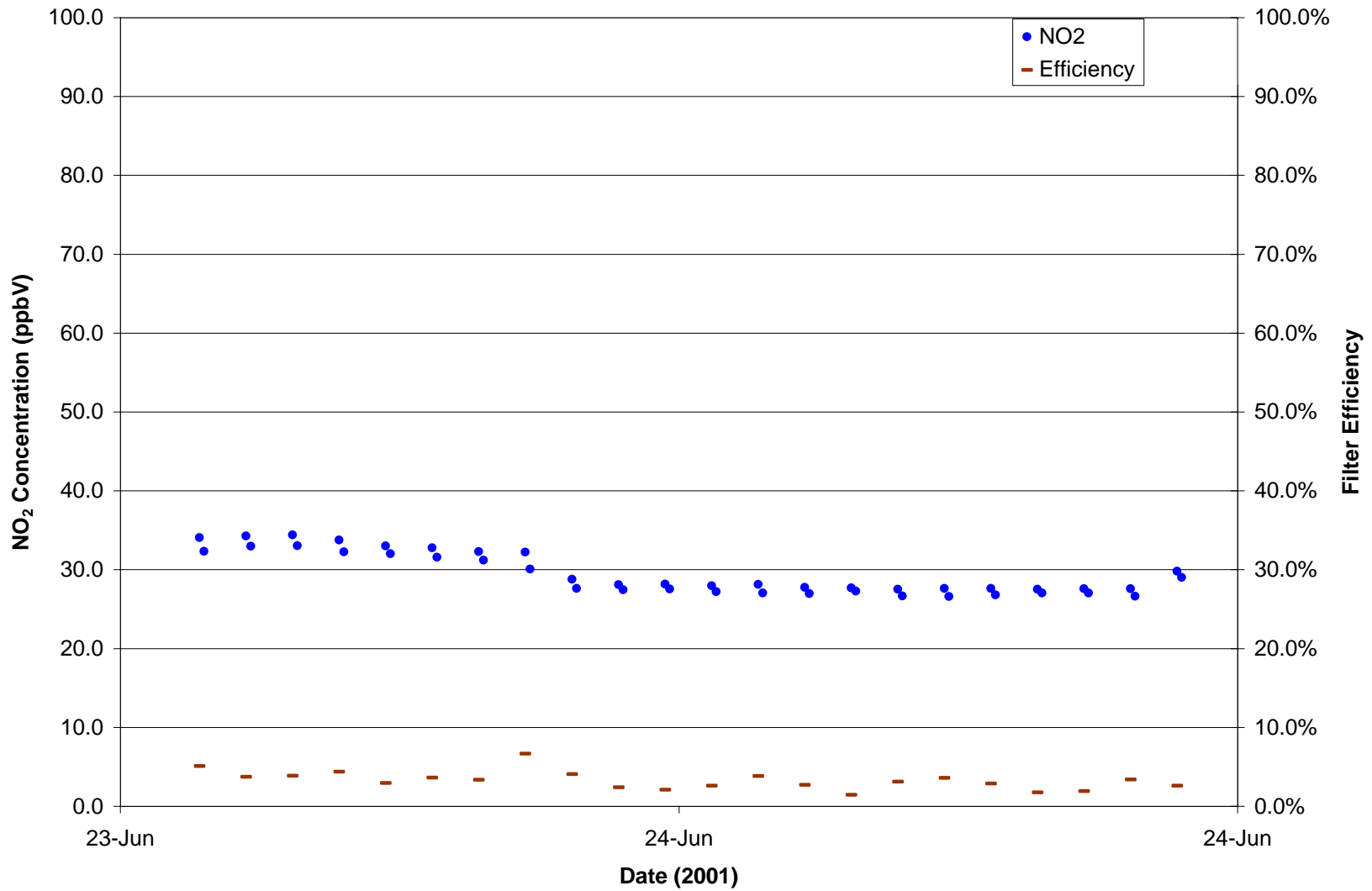

EPA Denuder Efficiency Evaluation Filter Section
Experiment 22: Low Humidity NO2 Test for Filter 3

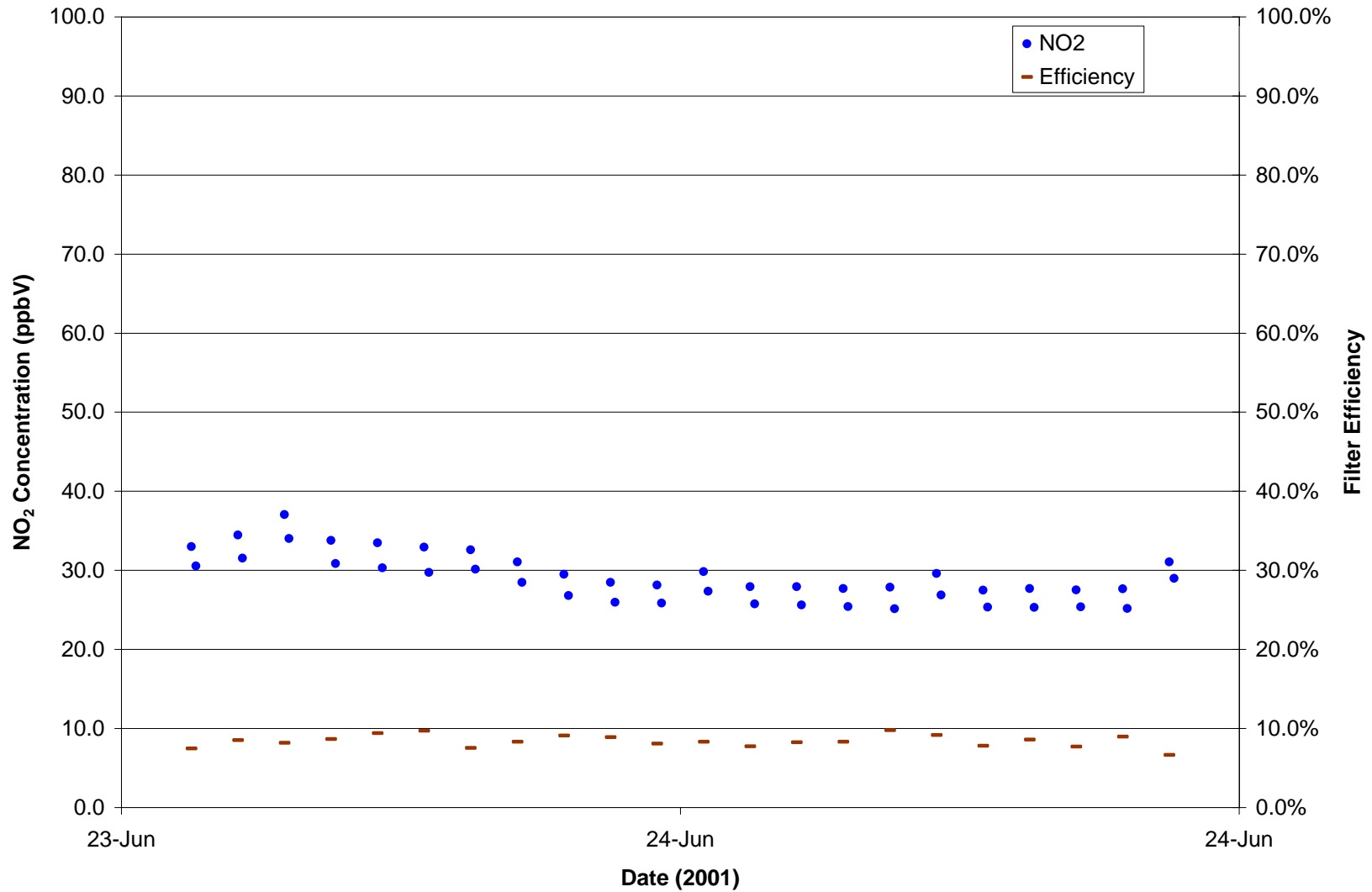

EPA Denuder Efficiency Evaluation Filter Section
Experiment 22: Low Humidity NO2 Test for Filter 2

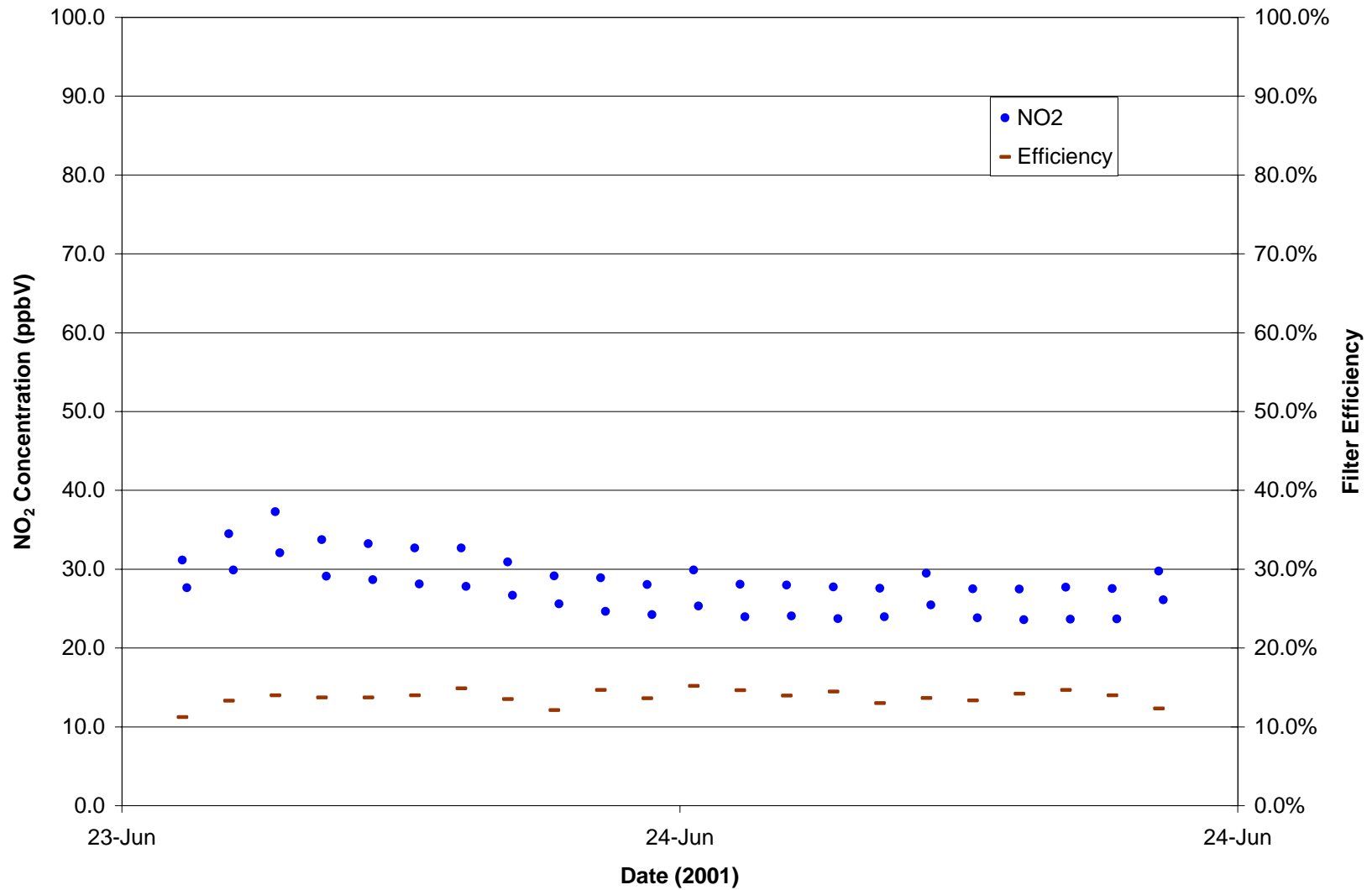

EPA Denuder Efficiency Evaluation Filter Section Experiment 22: Low Humidity NO2 Test for Filter 5

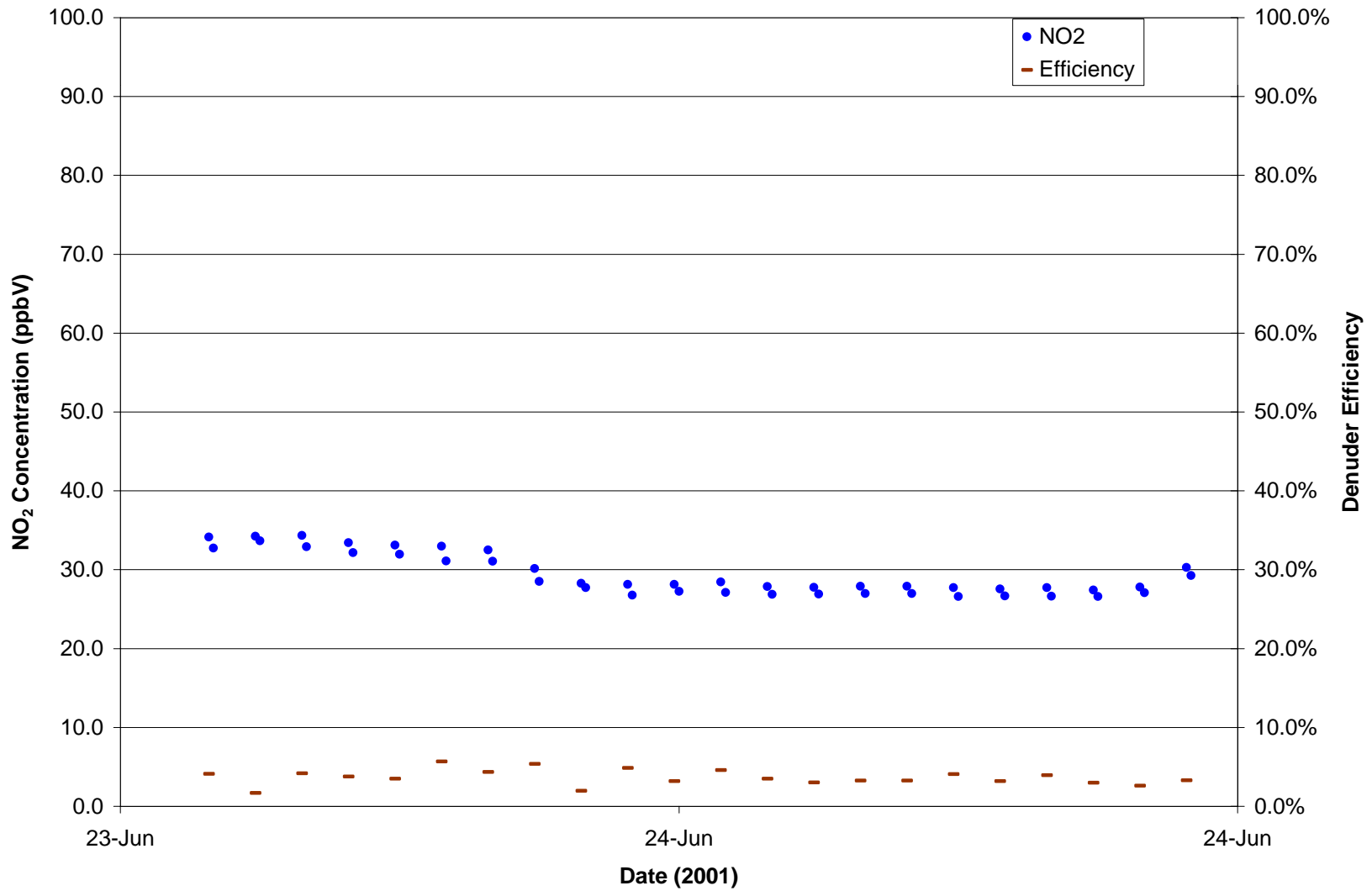

EPA Denuder Efficiency Evaluation Filter Section
Experiment 23: High Humidity NO2 Test for Filter 1

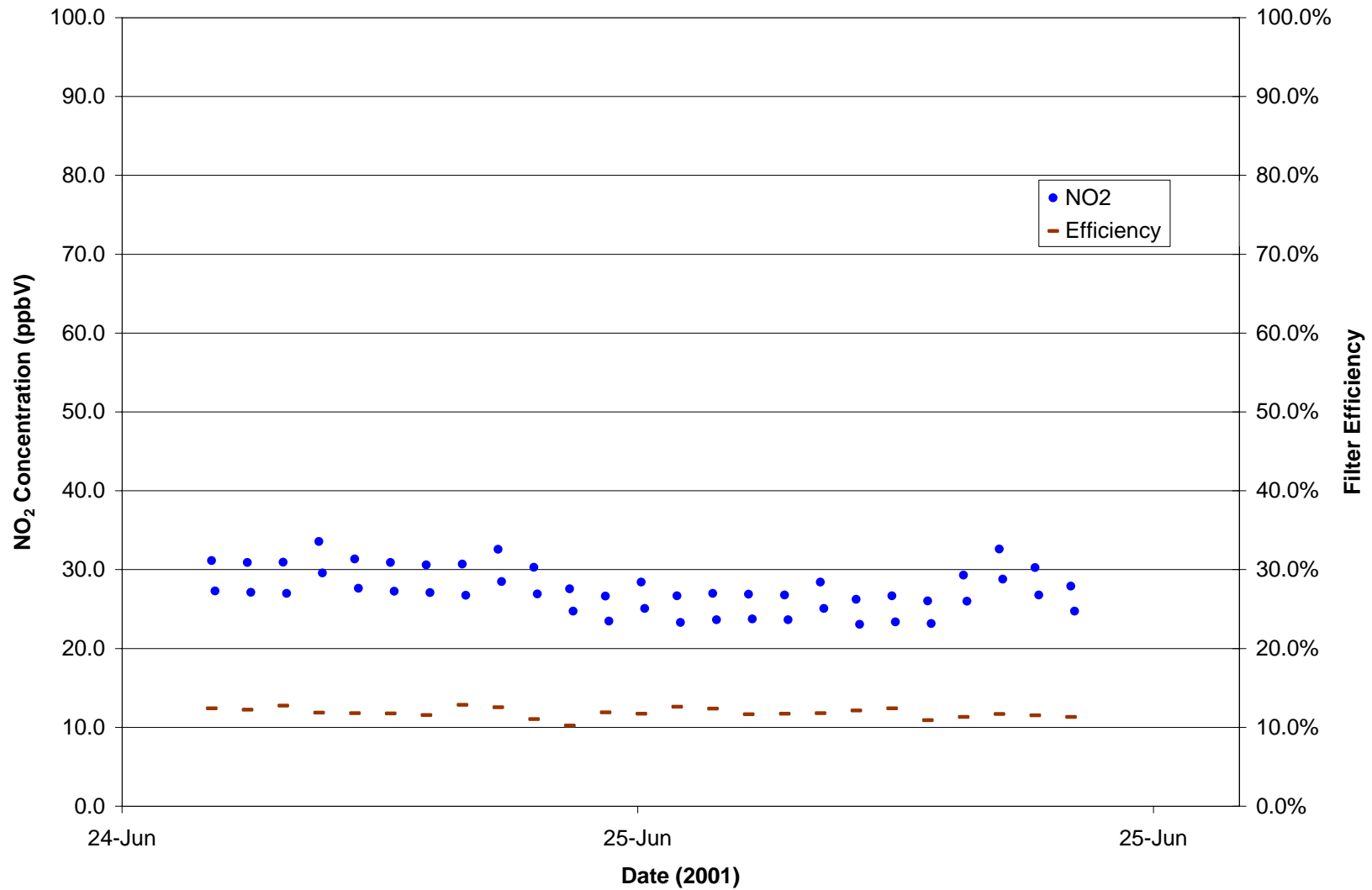

EPA Denuder Efficiency Evaluation Filter Section Experiment 23: High Humidity NO2 Test for Filter 4

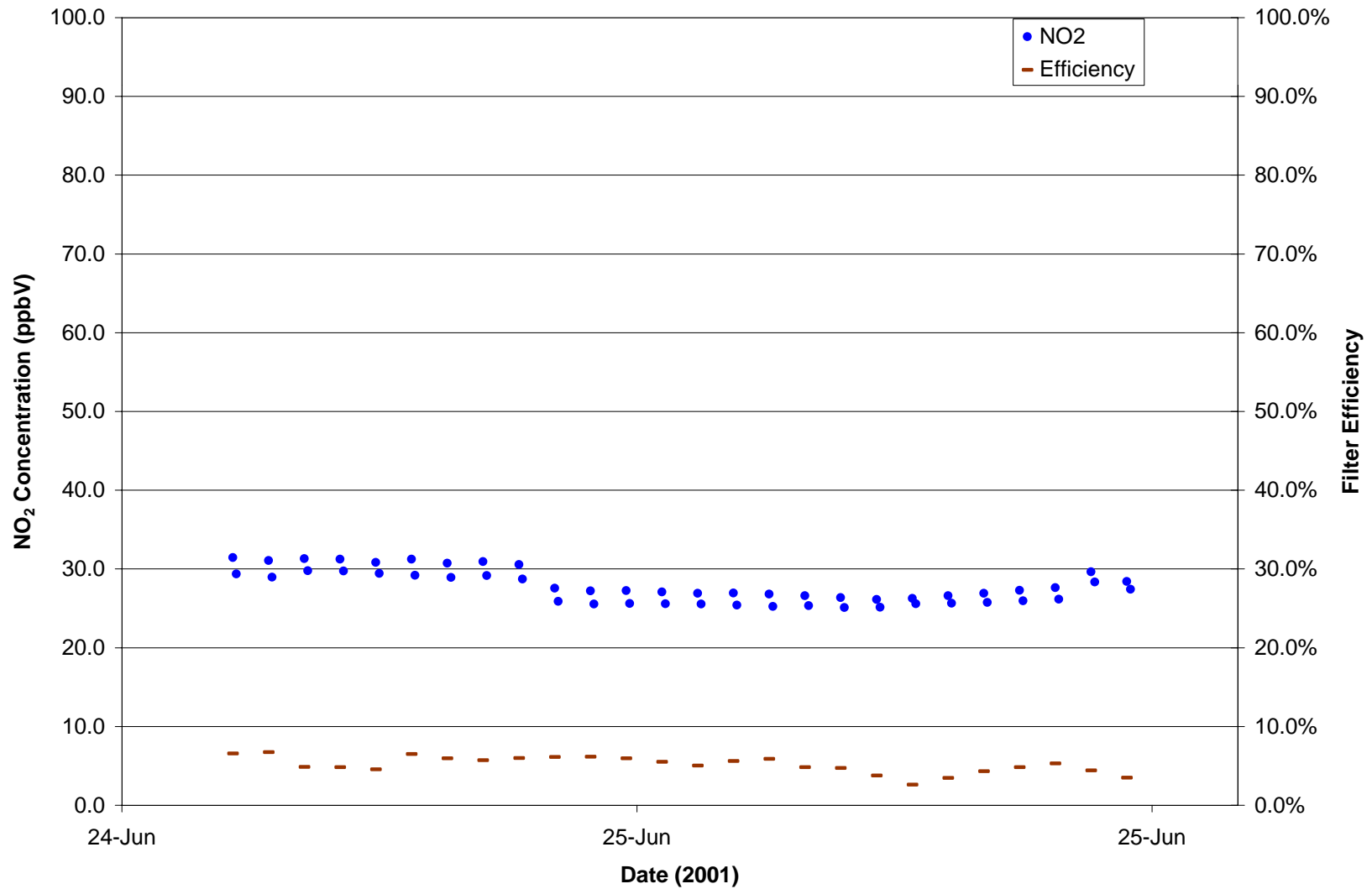

EPA Denuder Efficiency Evaluation Filter Section
Experiment 23: High Humidity NO2 Test for Filter 3

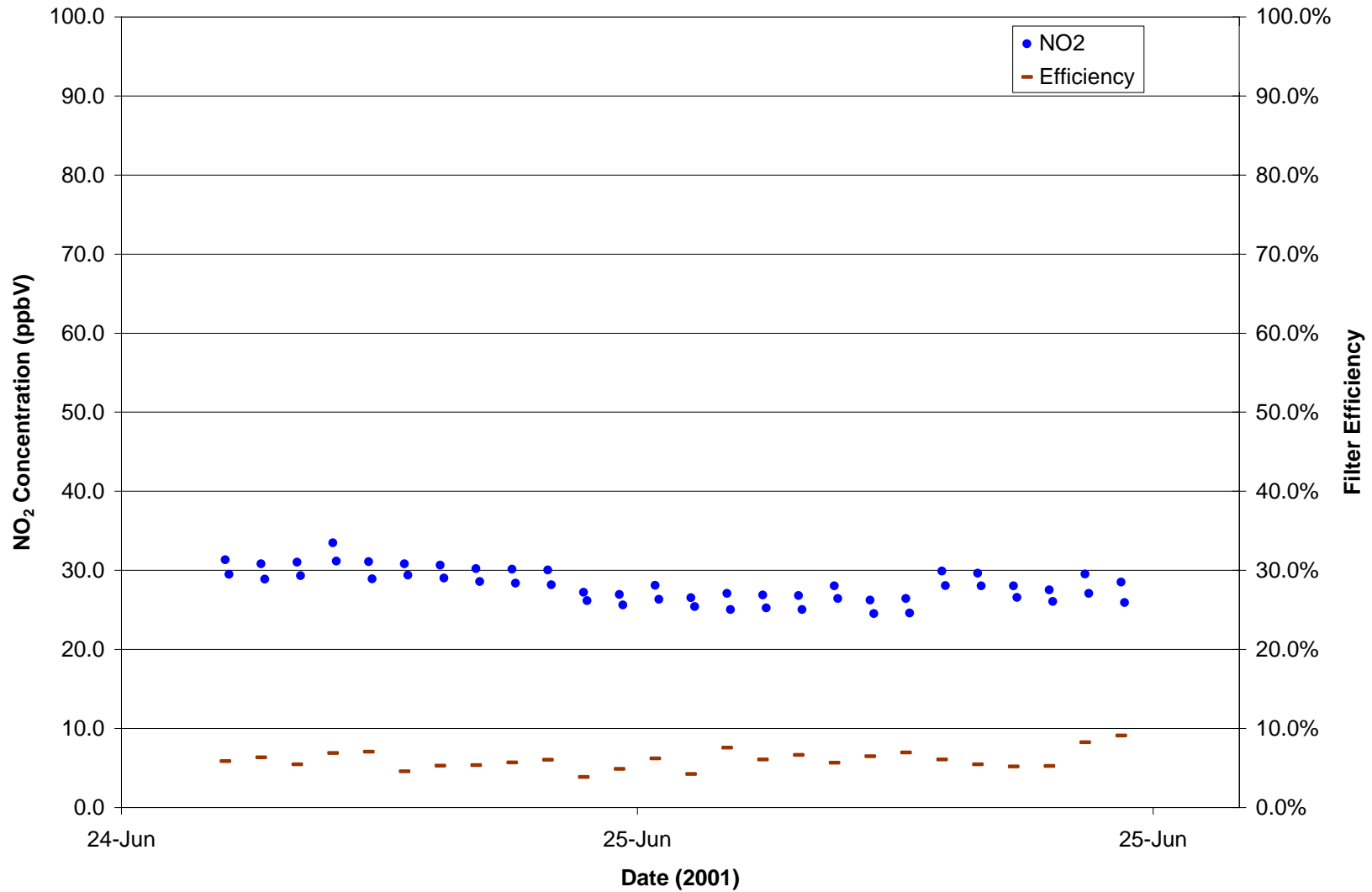

EPA Denuder Efficiency Evaluation Filter Section
Experiment 23: High Humidity NO2 Test for Filter 2

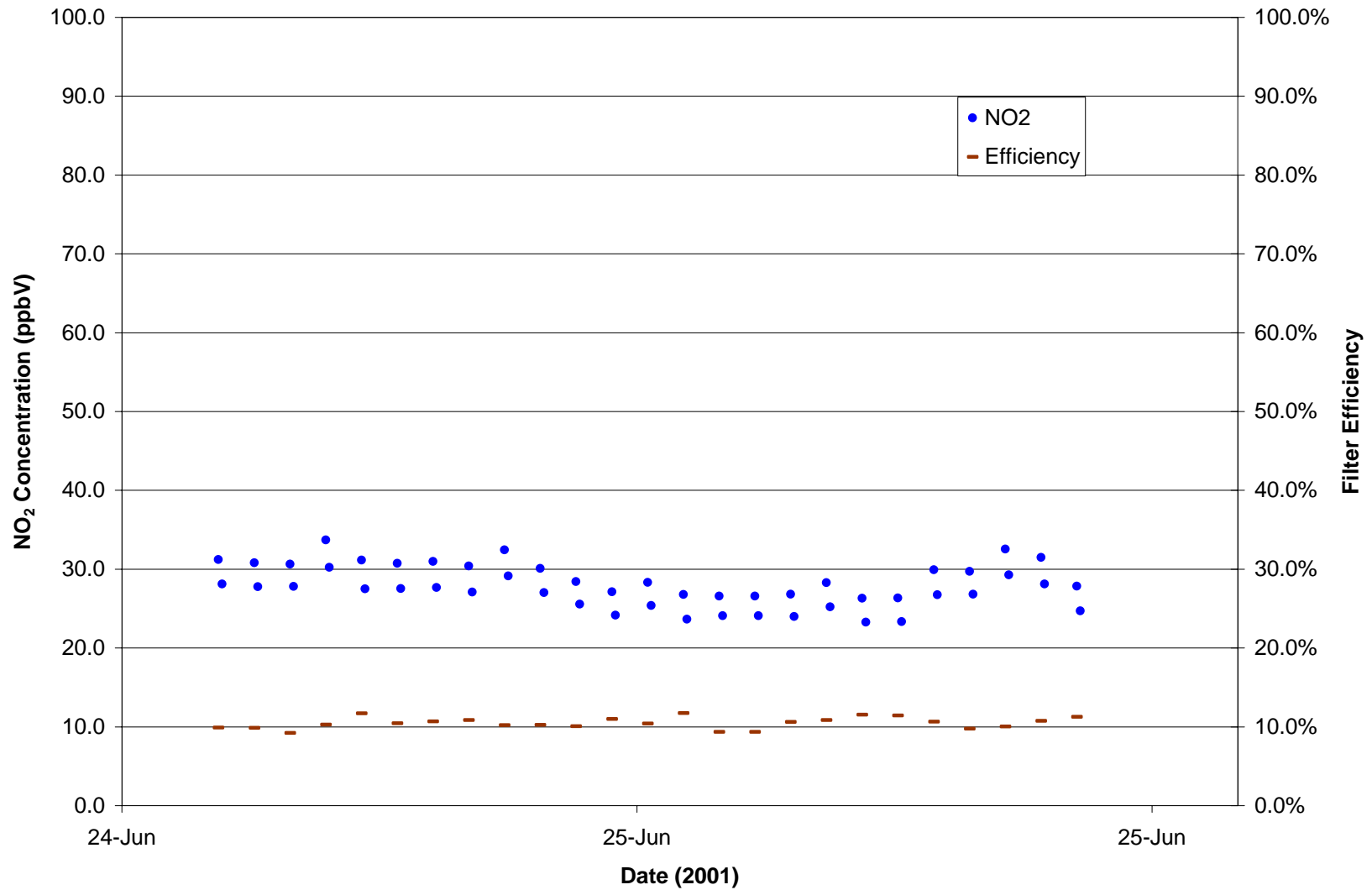

EPA Denuder Efficiency Evaluation Filter Section
Experiment 23: High Humidity NO2 Test for Filter 5

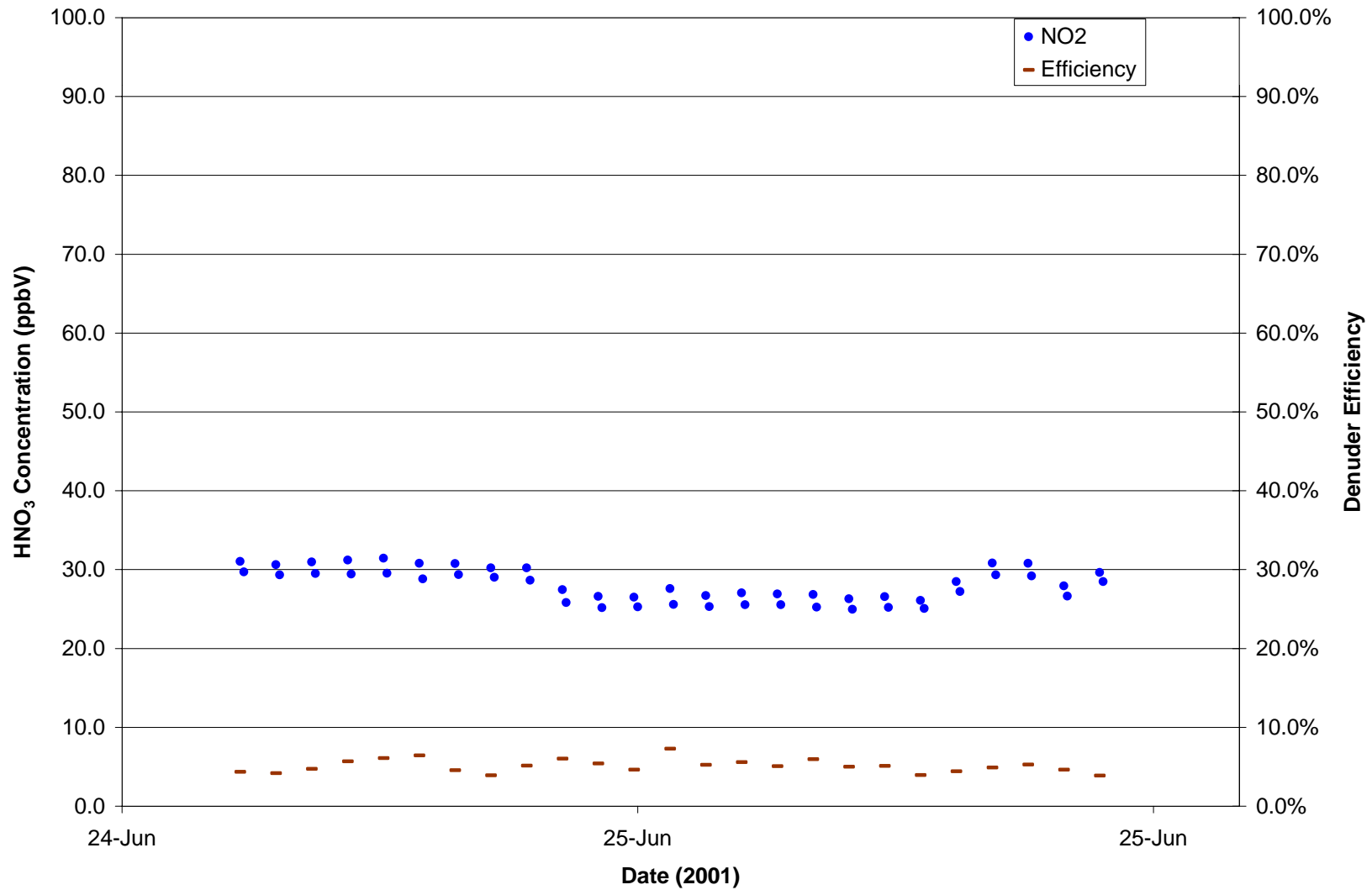

EPA Denuder Efficiency Evaluation Filter Section
Experiment 24: High Humidity HONO Test for Filter 1

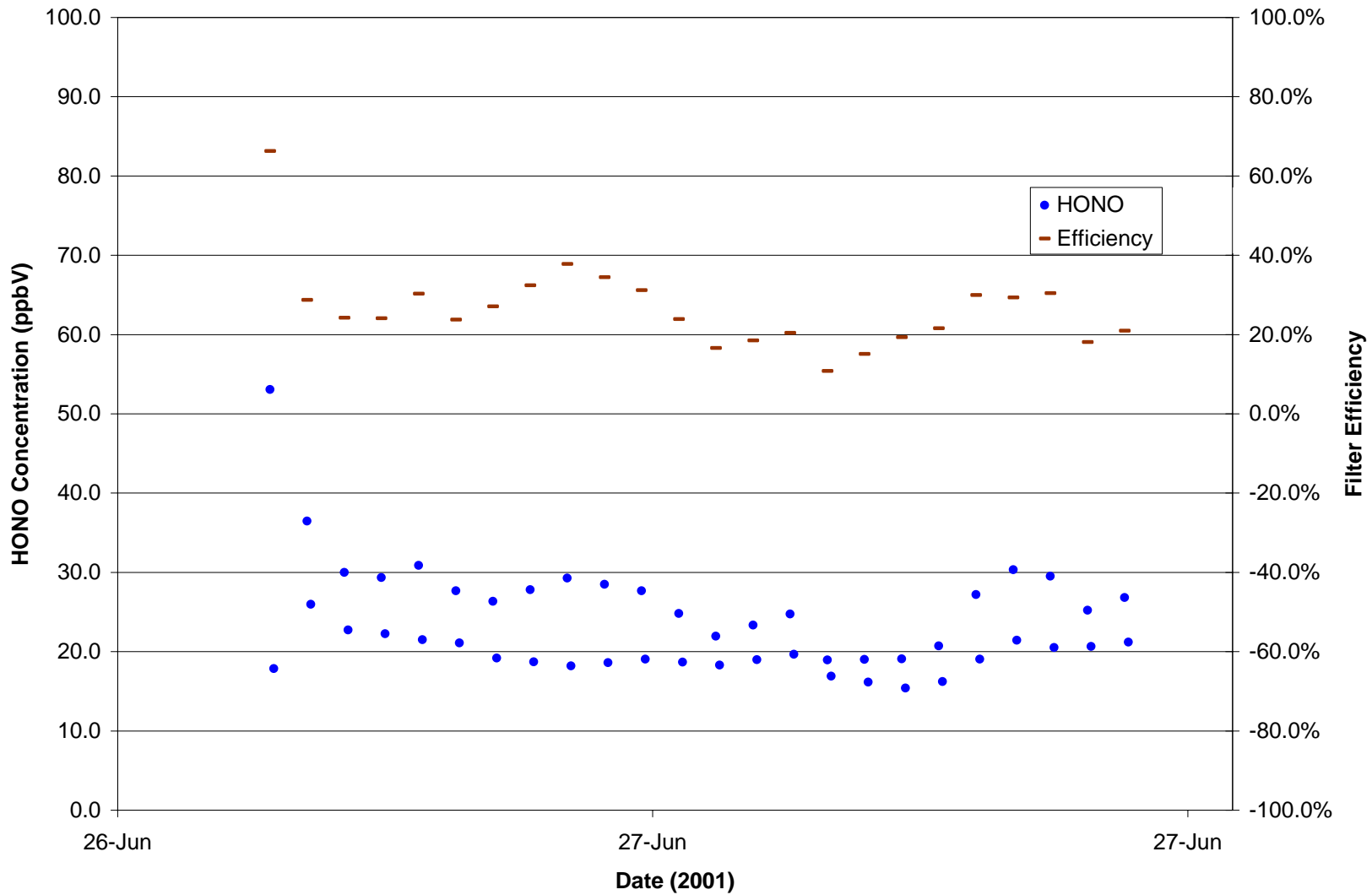

EPA Denuder Efficiency Evaluation Filter Section Experiment 24: High Humidity HONO Test for Filter 4

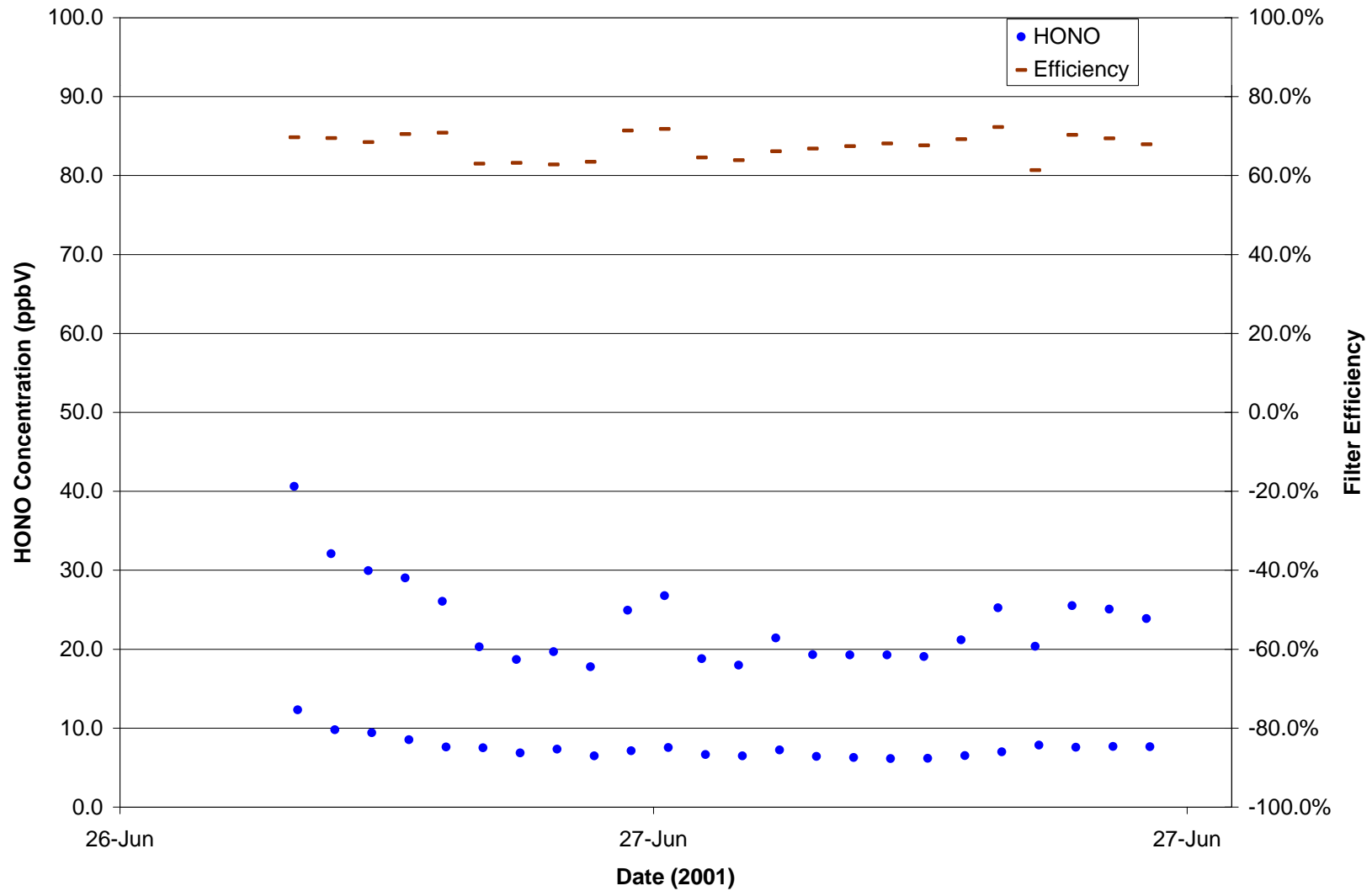

EPA Denuder Efficiency Evaluation Filter Section
Experiment 24: High Humidity HONO Test for Filter 3

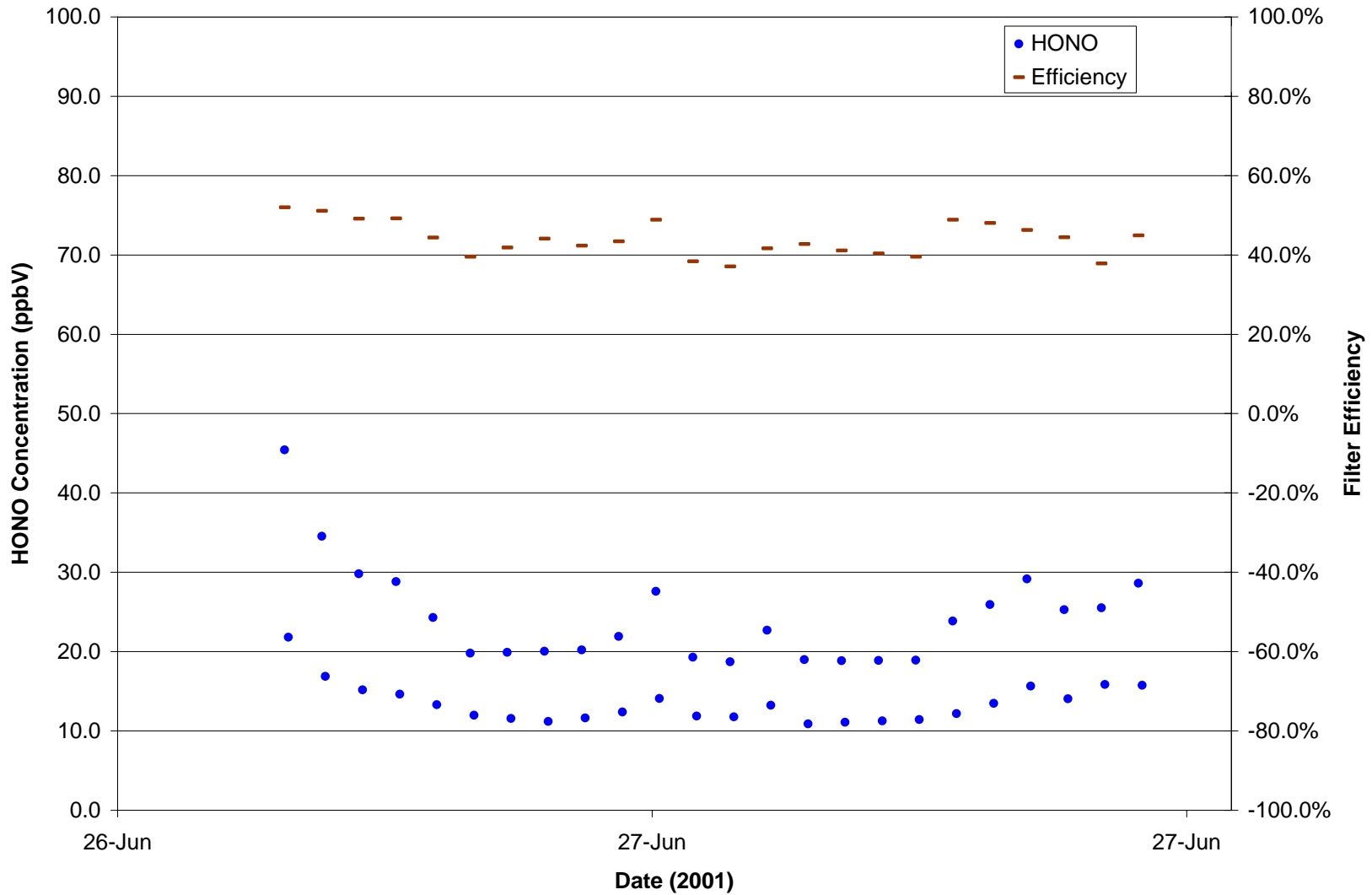

EPA Denuder Efficiency Evaluation Filter Section
Experiment 24: High Humidity HONO Test for Filter 2

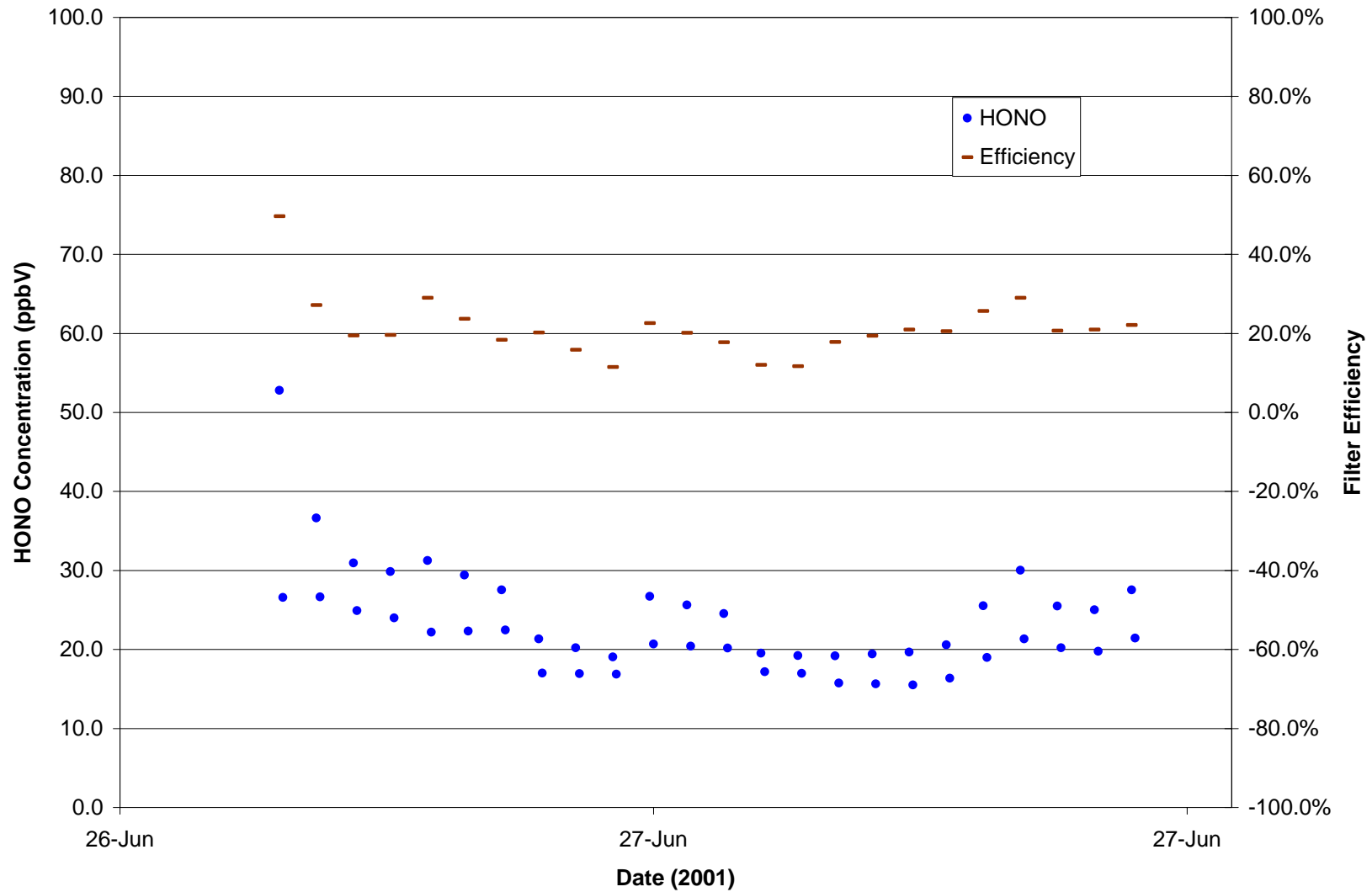

EPA Denuder Efficiency Evaluation Filter Section
Experiment 24: High Humidity HONO Test for Filter 5

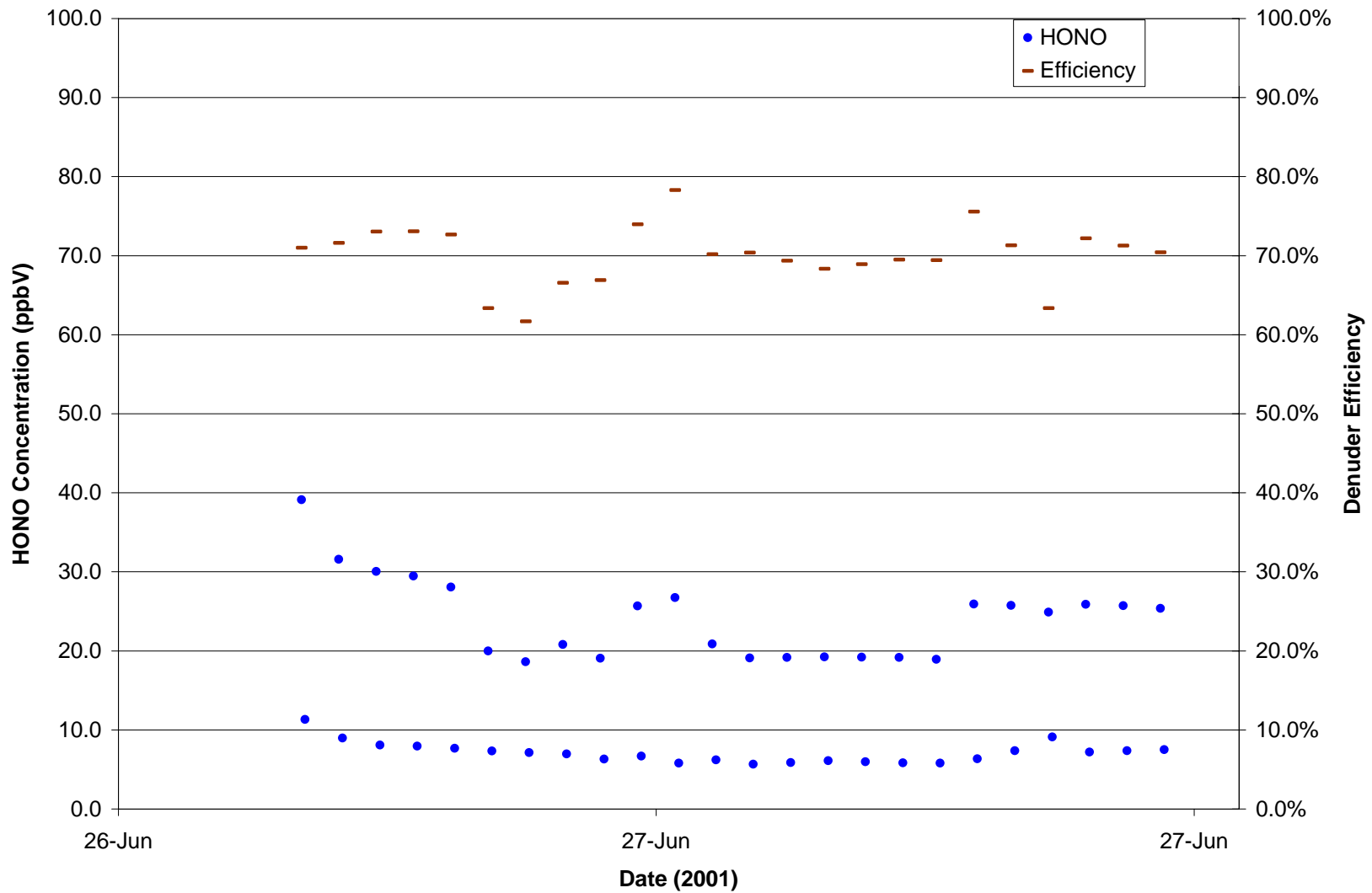

EPA Denuder Efficiency Evaluation Filter Section Experiment 25: Low Humidity HONO Test for Filter 1

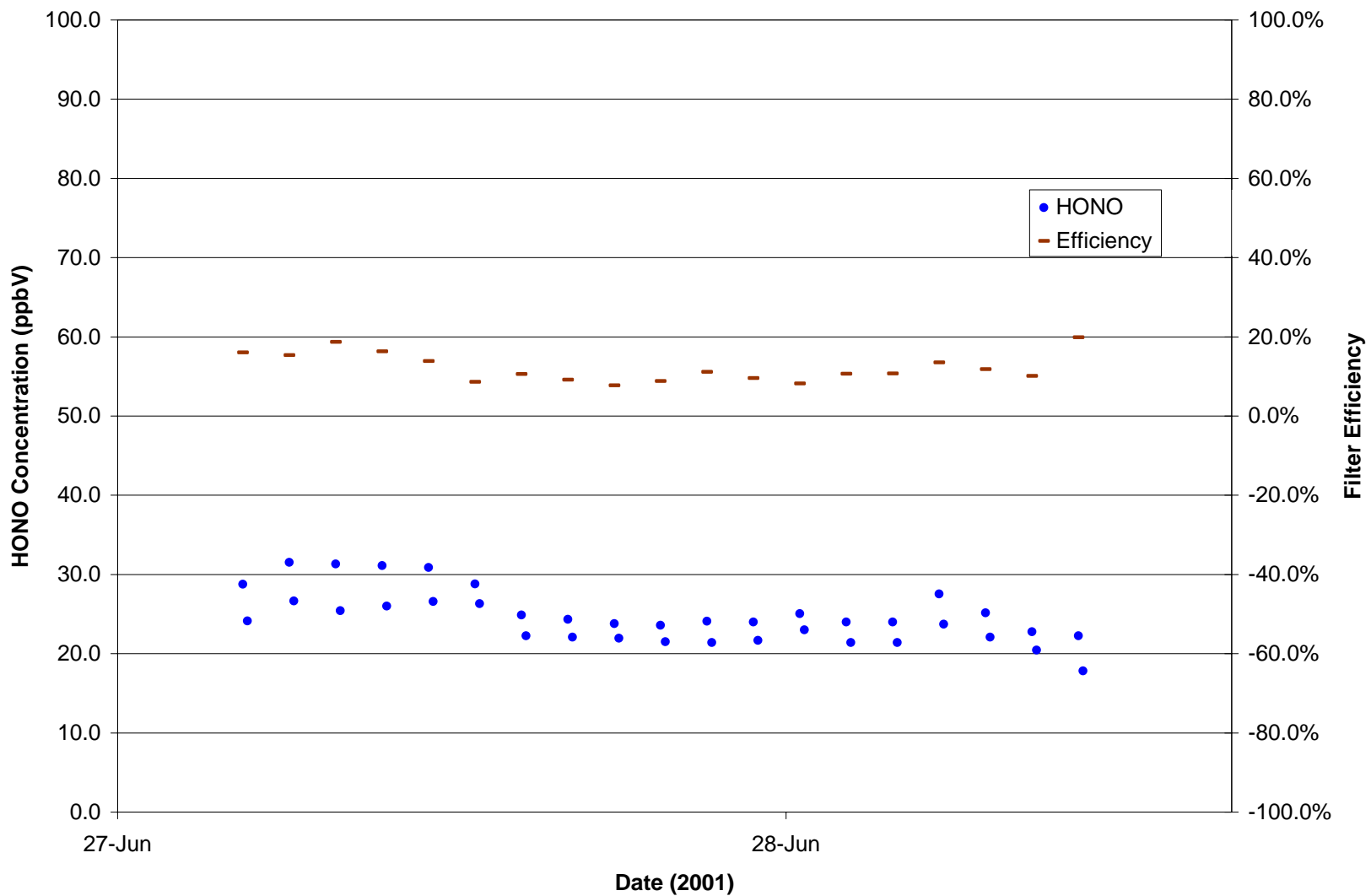

EPA Denuder Efficiency Evaluation Filter Section
Experiment 25: Low Humidity HONO Test for Filter 4

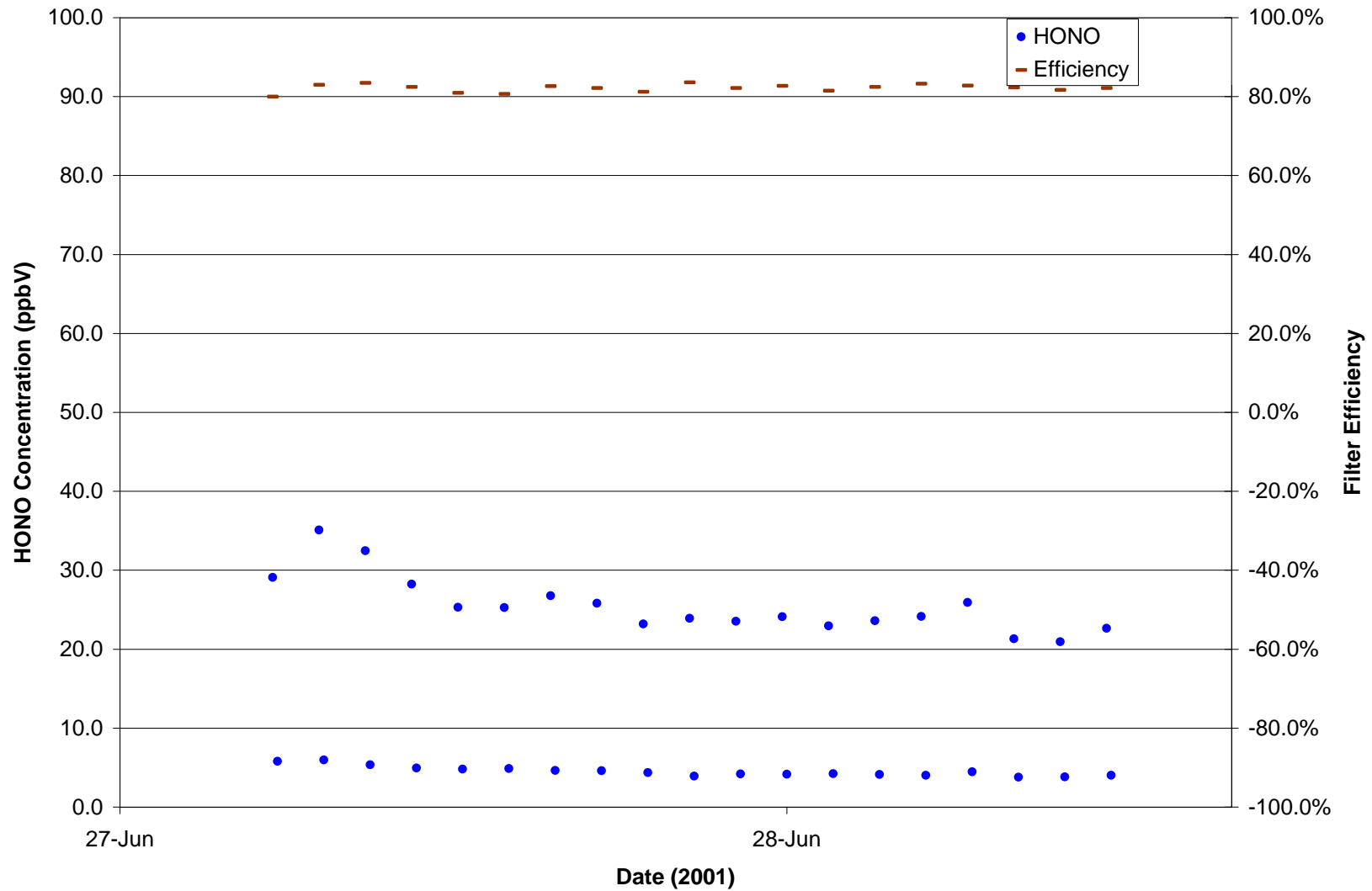

EPA Denuder Efficiency Evaluation Filter Section Experiment 25: Low Humidity HONO Test for Filter 3

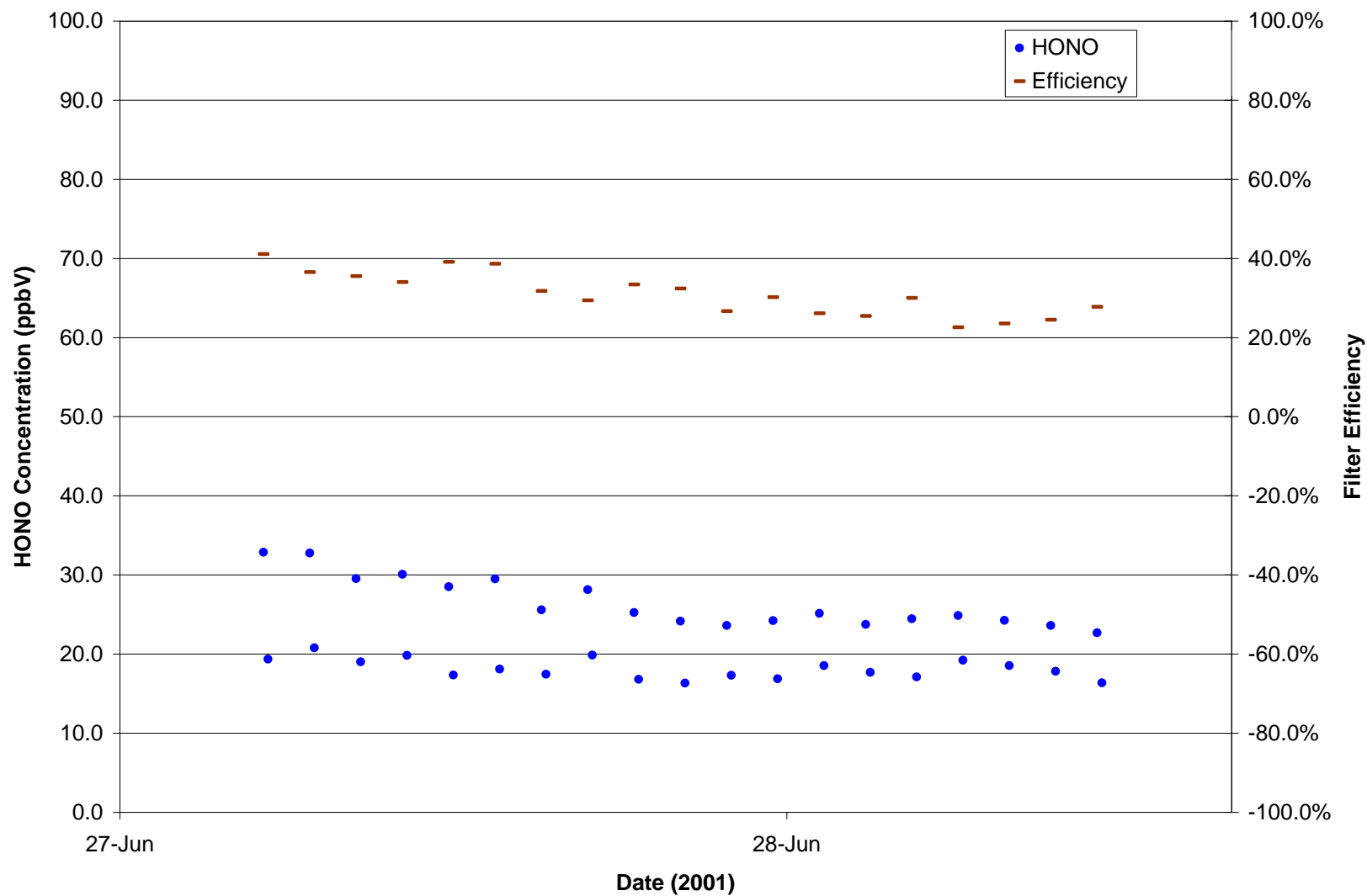

EPA Denuder Efficiency Evaluation Filter Section
Experiment 25: Low Humidity HONO Test for Filter 2

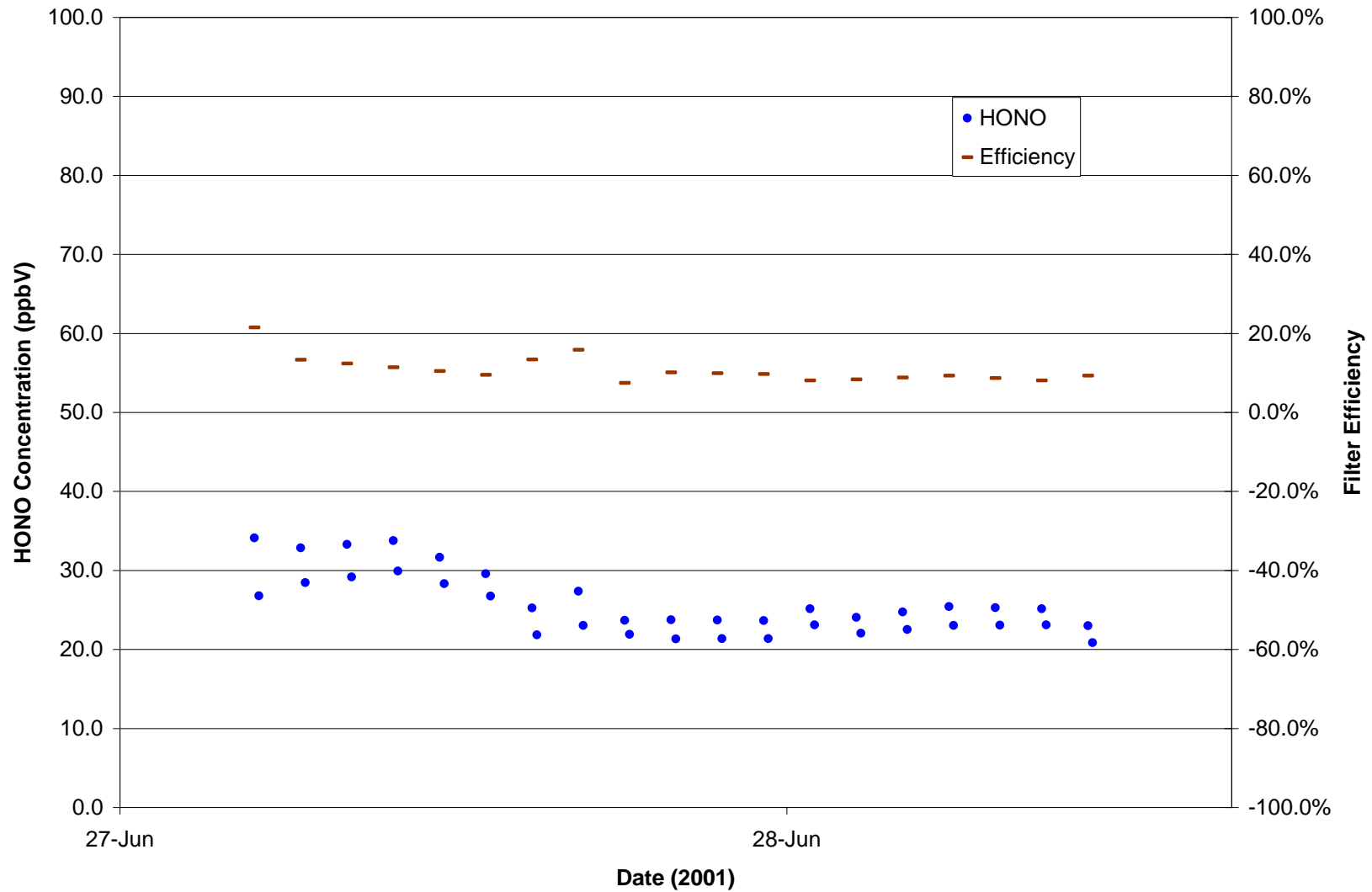

EPA Denuder Efficiency Evaluation Filter Section Experiment 25: Low Humidity HONO Test for Filter 5

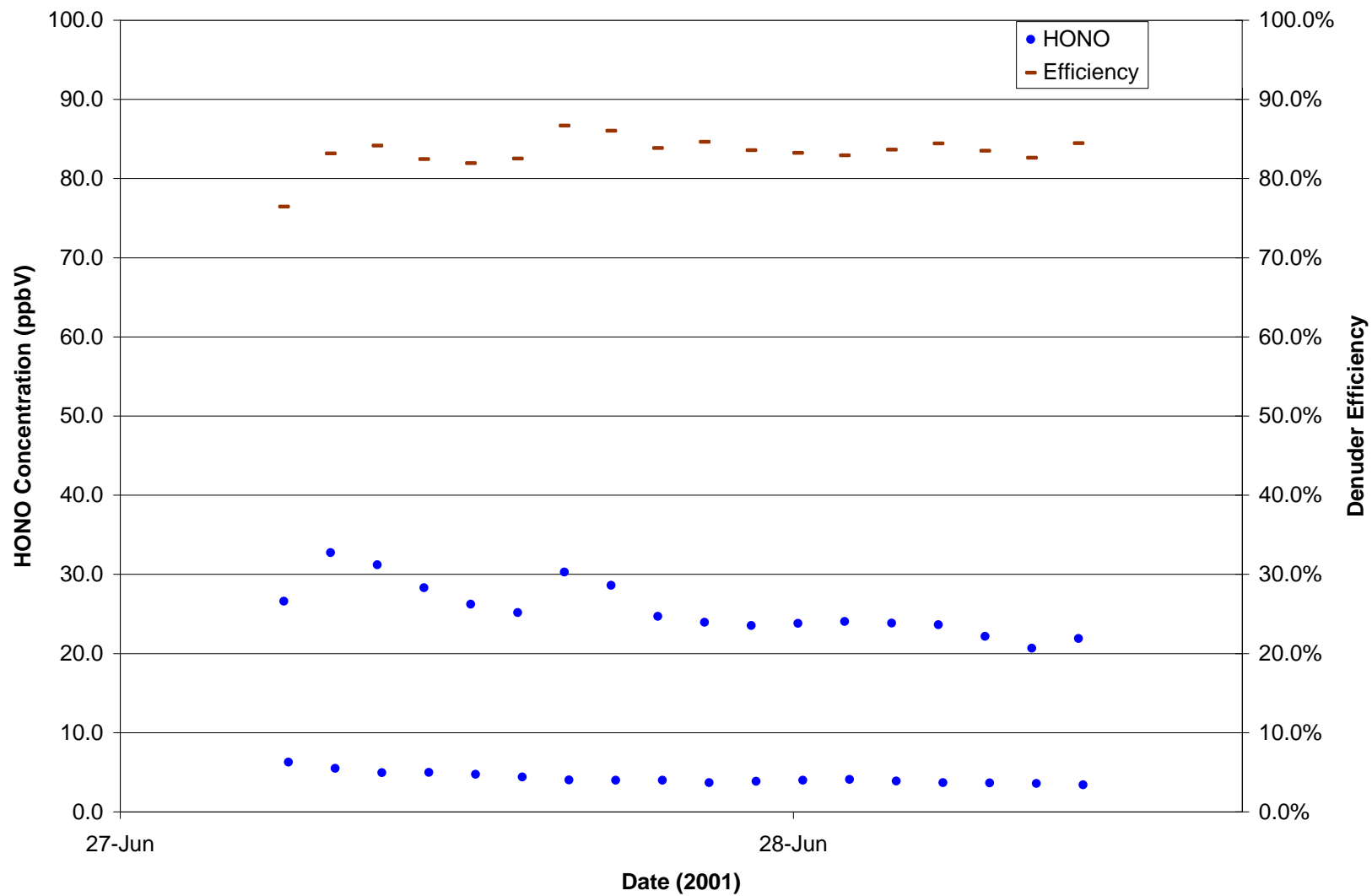

EPA Denuder Efficiency Evaluation Filter Section Experiment 26: Low Humidity PAN Test for Filter 1

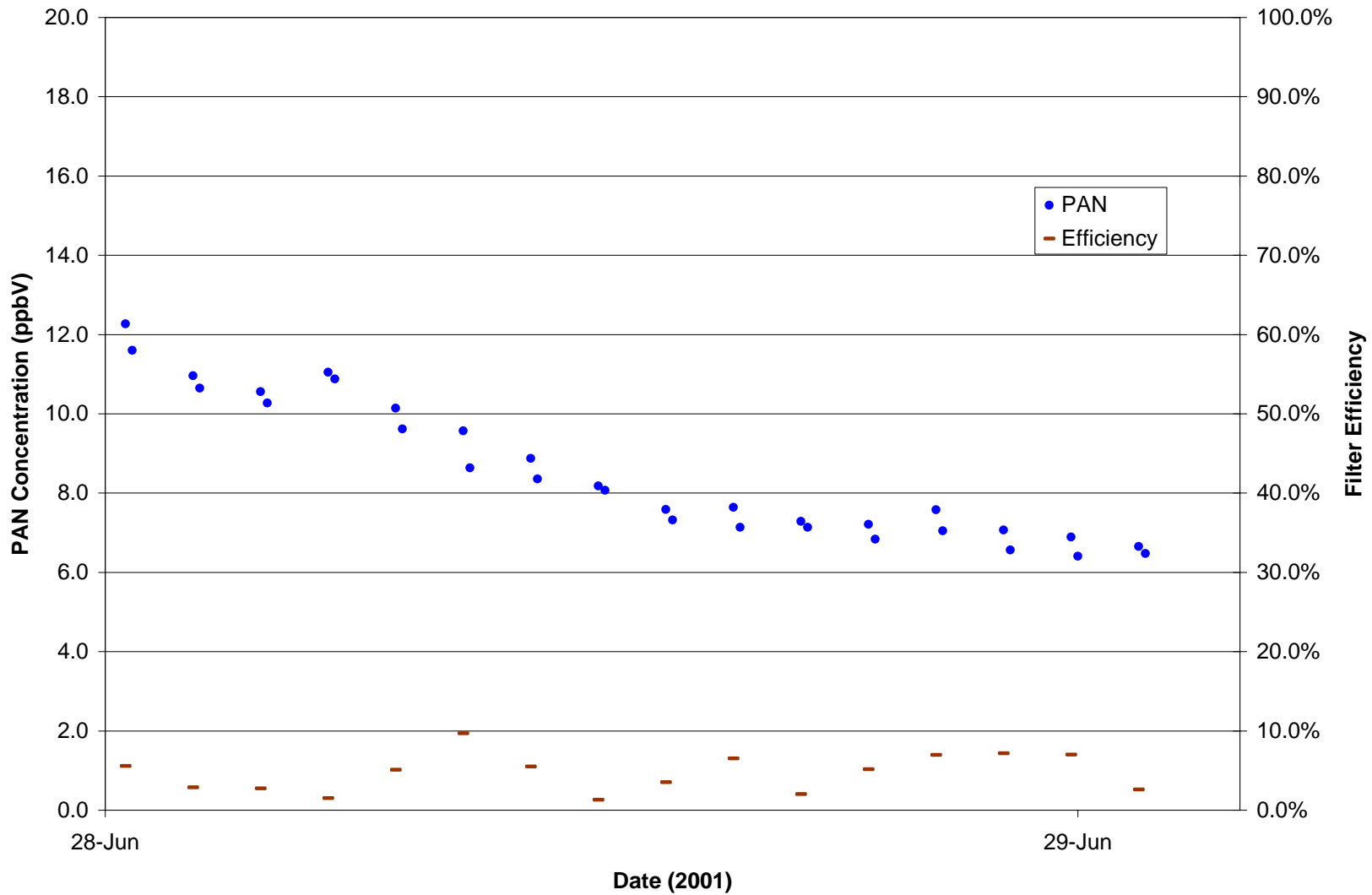

EPA Denuder Efficiency Evaluation Filter Section
Experiment 26: Low Humidity PAN Test for Filter 4

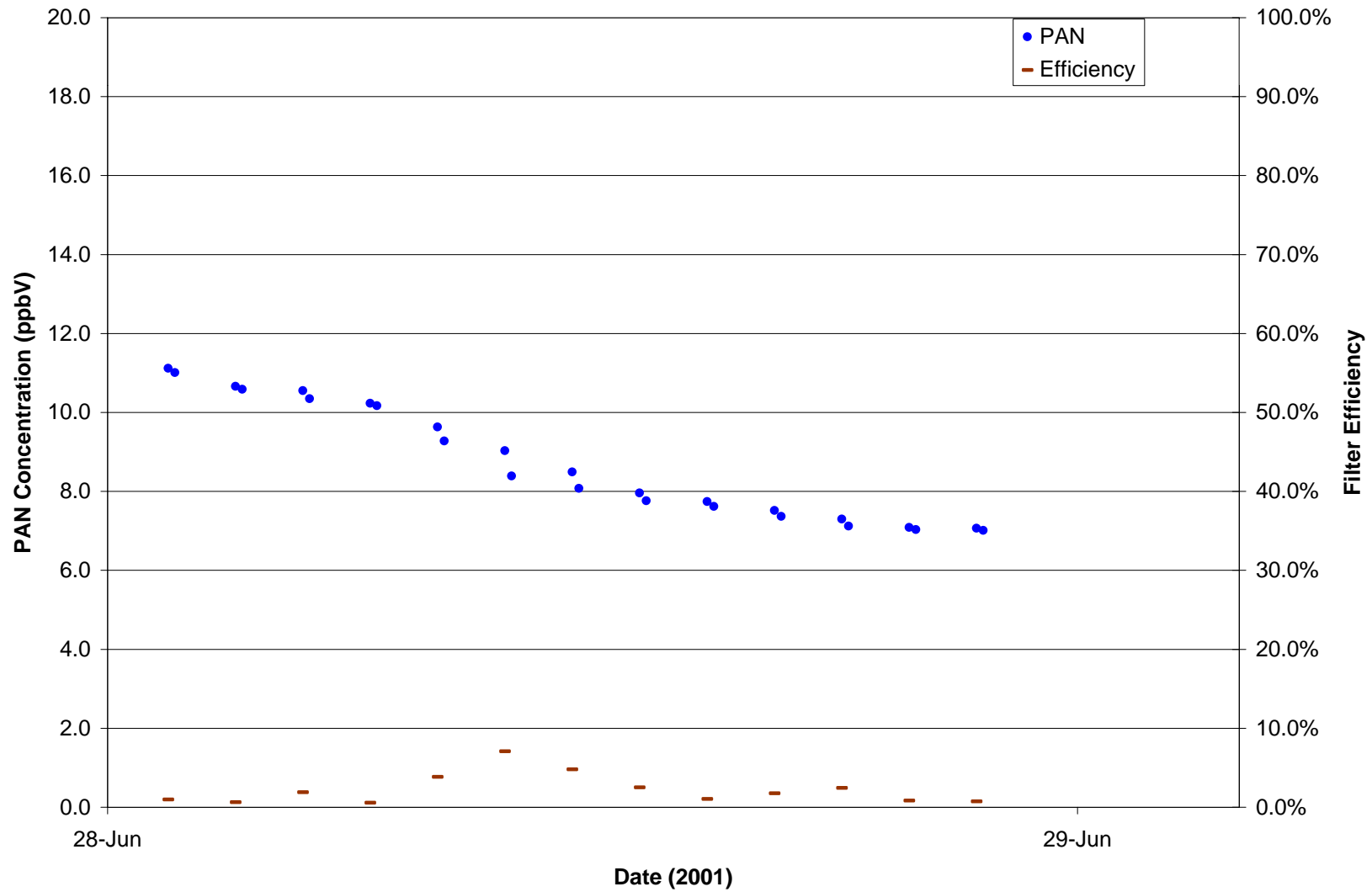

**EPA Denuder Efficiency Evaluation Filter Section
Experiment 26: Low Humidity PAN Test for Filter 3**

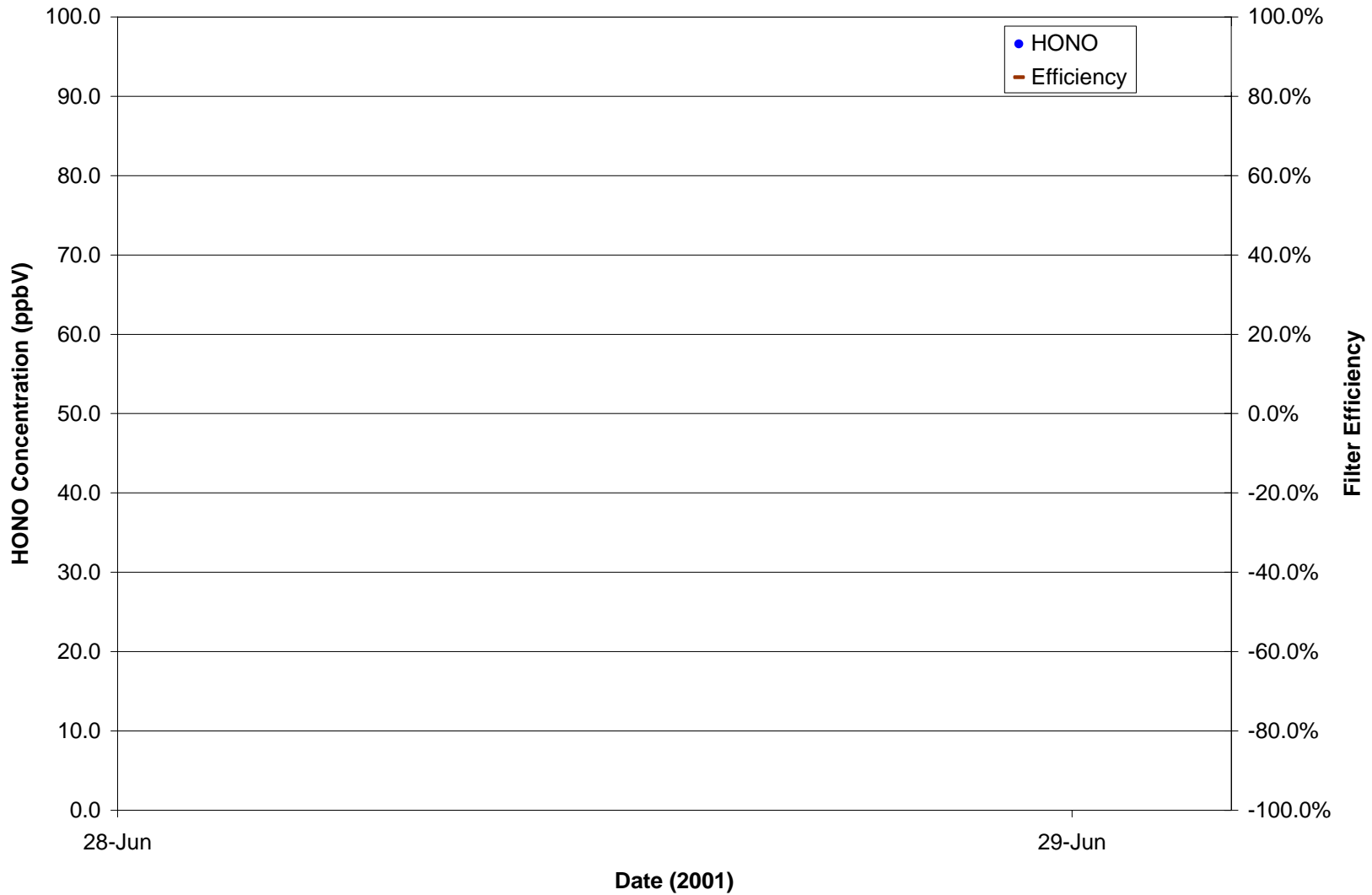

EPA Denuder Efficiency Evaluation Filter Section Experiment 26: Low Humidity PAN Test for Filter 2

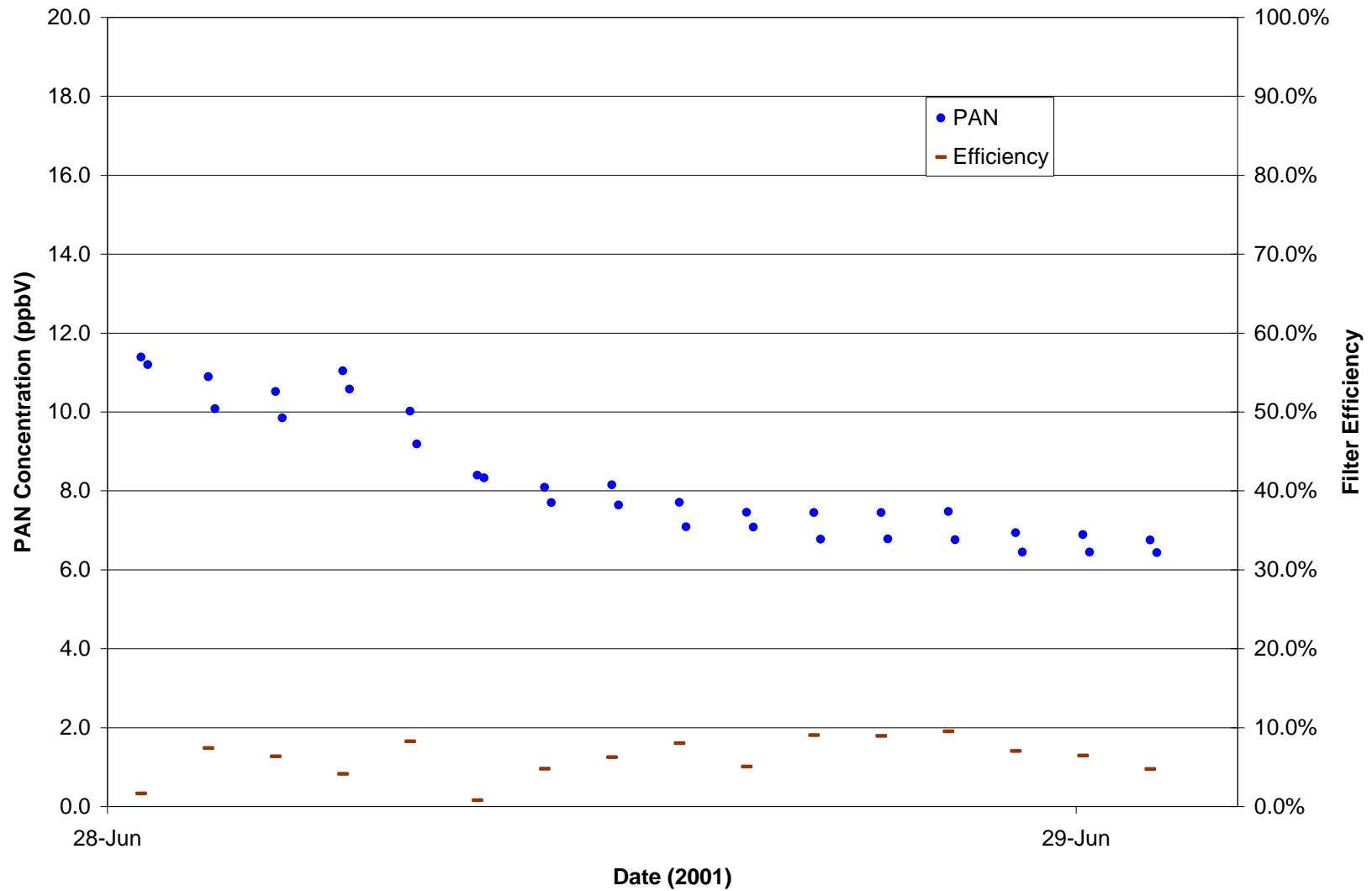

EPA Denuder Efficiency Evaluation Filter Section Experiment 26: Low Humidity Pan Test for Filter 5

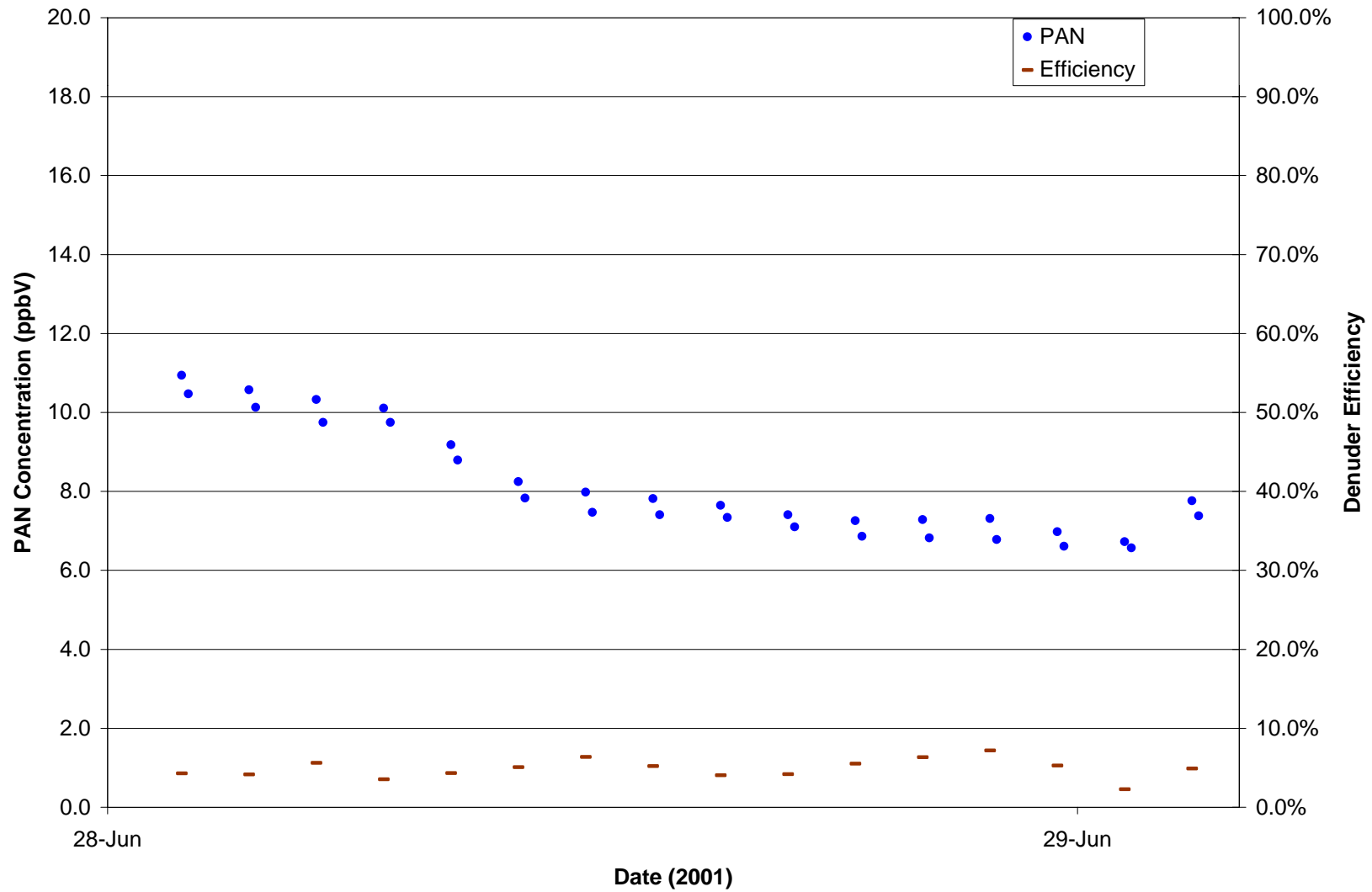

EPA Denuder Efficiency Evaluation Filter Section Experiment 27: High Humidity Pan Test for Filter 1

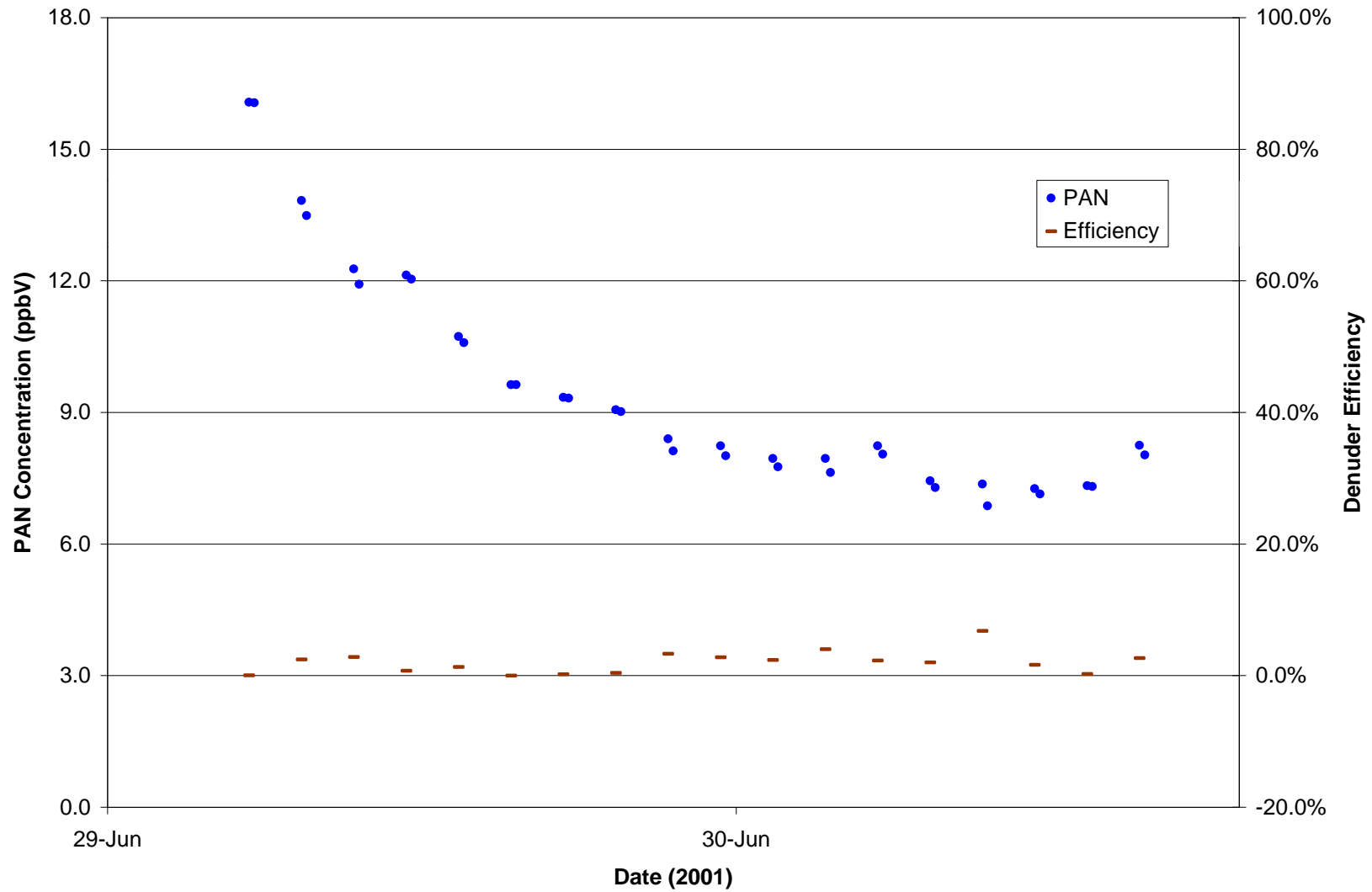

EPA Denuder Efficiency Evaluation Filter Section Experiment 27: High Humidity Pan Test for Filter 2

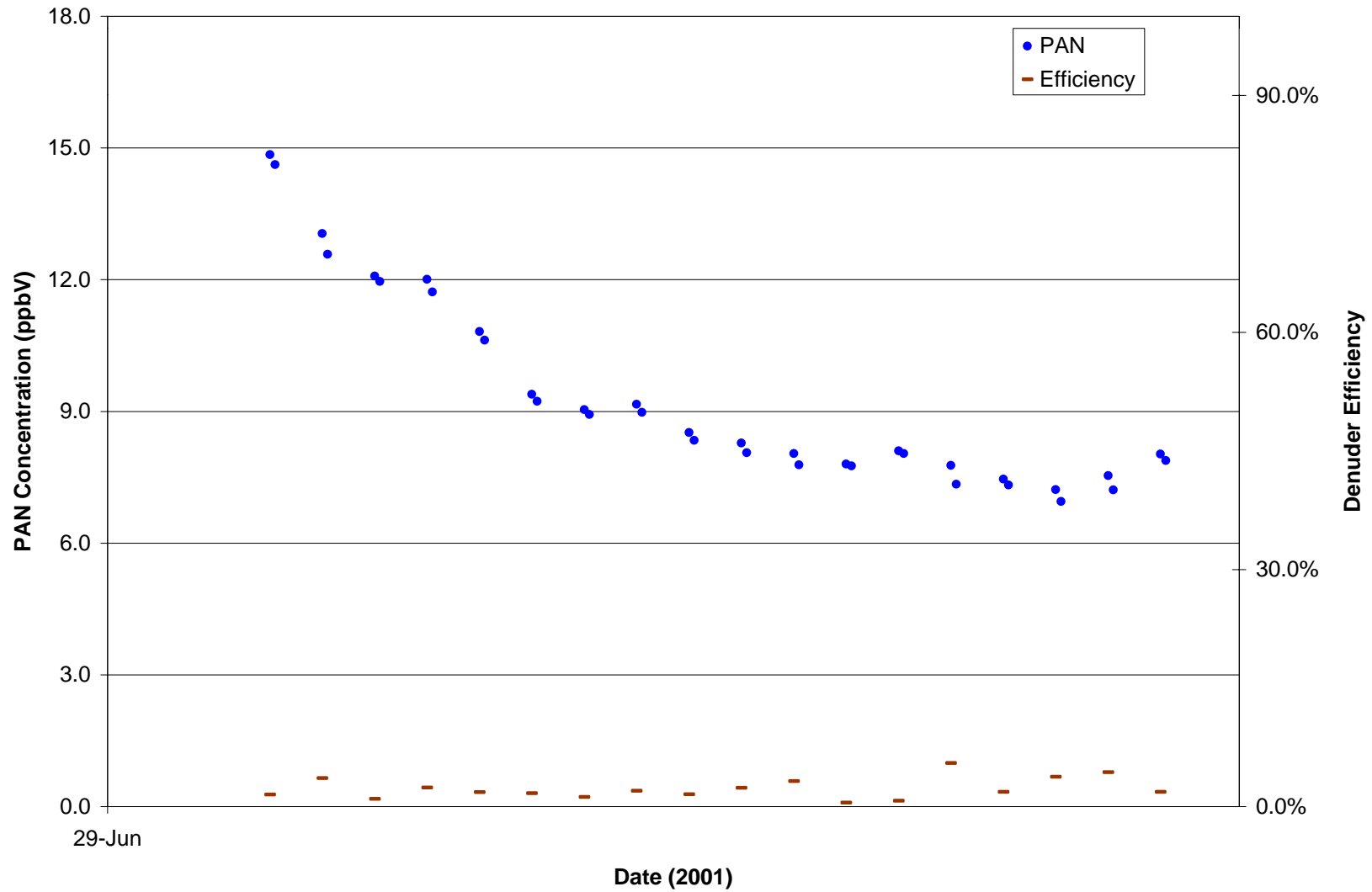

EPA Denuder Efficiency Evaluation Filter Section Experiment 27: High Humidity Pan Test for Filter 5

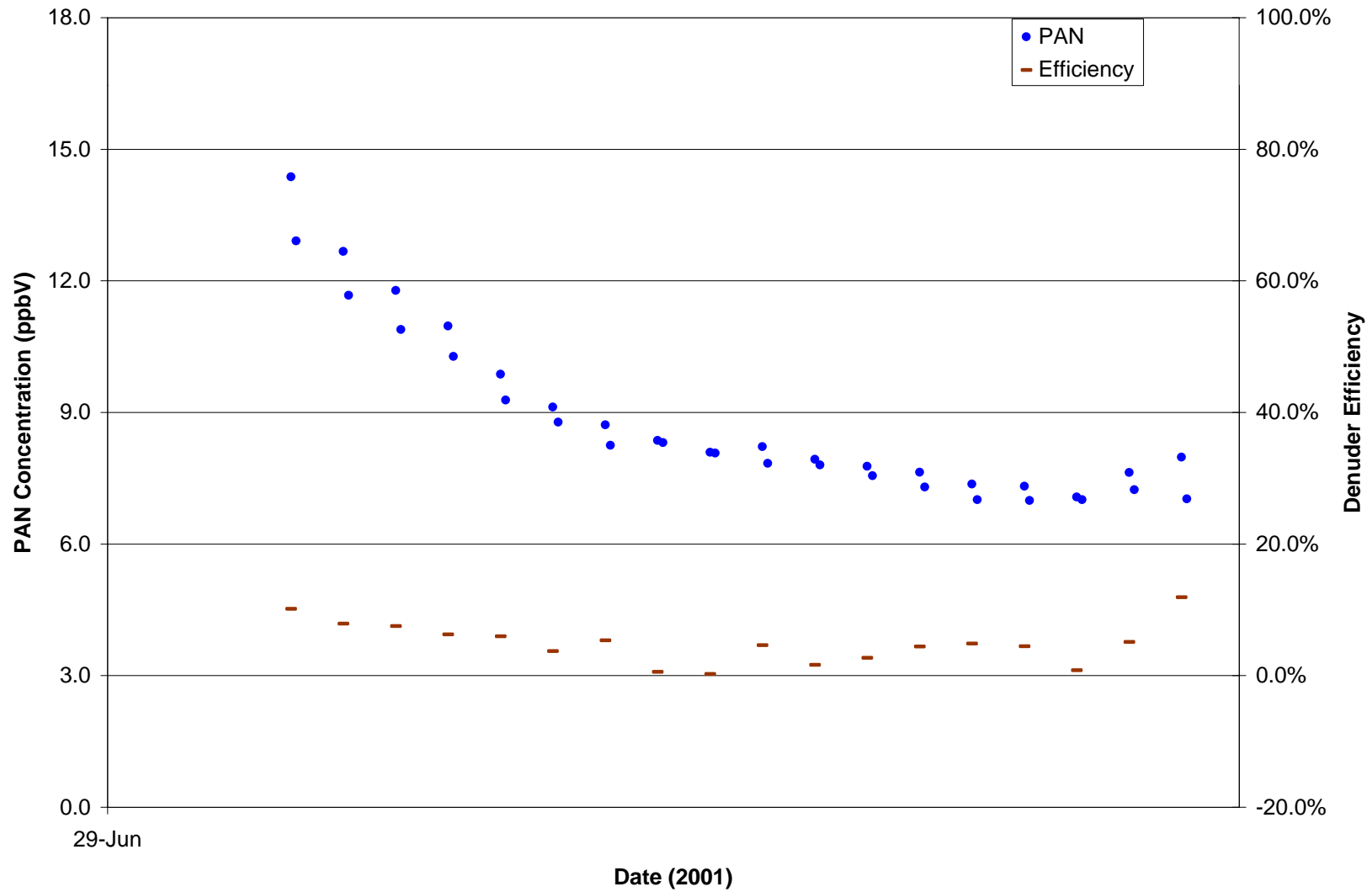

United States
Environmental Protection
Agency

Office of Air Quality Planning and Standards
Emissions Monitoring & Analysis Division
Research Triangle Park, NC

Publication No. EPA-454R-02-011
April 2002
